

Calhoun: The NPS Institutional Archive

Theses and Dissertations

Thesis Collection

2006-03

Mine Drop Experiment II with operational mine shapes (MIDEX II)

Allen, Charles R.

Monterey, California. Naval Postgraduate School

<http://hdl.handle.net/10945/2863>



Calhoun is a project of the Dudley Knox Library at NPS, furthering the precepts and goals of open government and government transparency. All information contained herein has been approved for release by the NPS Public Affairs Officer.

Dudley Knox Library / Naval Postgraduate School
411 Dyer Road / 1 University Circle
Monterey, California USA 93943

<http://www.nps.edu/library>



**NAVAL
POSTGRADUATE
SCHOOL**

MONTEREY, CALIFORNIA

THESIS

**MINE DROP EXPERIMENT II WITH OPERATIONAL
MINE SHAPES (MIDEX II)**

by

Charles R. Allen

March 2006

Thesis Advisor:
Second Reader:

Peter Chu
Peter Fleischer

Approved for public release, distribution is unlimited

THIS PAGE INTENTIONALLY LEFT BLANK

REPORT DOCUMENTATION PAGE			Form Approved OMB No. 0704-0188	
Public reporting burden for this collection of information is estimated to average 1 hour per response, including the time for reviewing instruction, searching existing data sources, gathering and maintaining the data needed, and completing and reviewing the collection of information. Send comments regarding this burden estimate or any other aspect of this collection of information, including suggestions for reducing this burden, to Washington headquarters Services, Directorate for Information Operations and Reports, 1215 Jefferson Davis Highway, Suite 1204, Arlington, VA 22202-4302, and to the Office of Management and Budget, Paperwork Reduction Project (0704-0188) Washington DC 20503.				
1. AGENCY USE ONLY (Leave blank)		2. REPORT DATE March 2006	3. REPORT TYPE AND DATES COVERED Master's Thesis	
4. TITLE AND SUBTITLE: Mine Drop Experiment II with Operational Mine Shapes (MIDEX II)			5. FUNDING NUMBERS N0001405WR20052	
6. AUTHOR(S) Charles R. Allen				
7. PERFORMING ORGANIZATION NAME(S) AND ADDRESS(ES) Naval Postgraduate School Monterey, CA 93943-5000			8. PERFORMING ORGANIZATION REPORT NUMBER	
9. SPONSORING /MONITORING AGENCY NAME(S) AND ADDRESS(ES) NAVOCEANO, Stennis Space Center, MS 39522-5001 Institute of Joint Warfare Analysis, NPS, Monterey, CA 93943			10. SPONSORING/MONITORING AGENCY REPORT NUMBER	
11. SUPPLEMENTARY NOTES The views expressed in this thesis are those of the author and do not reflect the official policy or position of the Department of Defense or the U.S. Government.				
12a. DISTRIBUTION / AVAILABILITY STATEMENT Approved for public release, distribution is unlimited.			12b. DISTRIBUTION CODE	
13. ABSTRACT (maximum 200 words) The Navy's Impact Burial Model (IMPACT35) predicts the cylindrical mine trajectory in air and water columns and burial depth and orientation in sediment. Impact burial calculations are derived primarily from the sediment characteristics and from the mine's three-dimensional air and water phase trajectories. Accurate burial prediction requires that the model's water phase trajectory reasonably mimics the object's true trajectory. In order to determine what effect varying the shape to more closely match real-world mines has on the shape's water phase trajectory, Mine Drop Experiment II was conducted. The experiment consisted of dropping four separate types of scaled shapes (Sphere, Gumdrop, Manta, and Rockan) into a water column, and the resultant falls were filmed from two nearly orthogonal angles. Initial drop position, initial velocities, and the drop angle were controlled parameters. The Sphere and Gumdrop shapes tended to have smooth arcing drop paths. The Manta shape dropped much more slowly than the Sphere or Gumdrop shapes. The Manta had a tendency to either fall in a spiral with its bottom parallel to the bottom or on its side in a twisting motion. The Rockan tended to either flip or swoop as it entered the water but then settle in a slow spin with its primary length parallel to the bottom. The dispersion of all four shapes at the selected depth of 2.5 m was wide and variable. The data collected from the experiment can be used to develop and validate the mine Impact Burial Prediction Model with operational, non-cylindrical mine shapes.				
14. SUBJECT TERMS Mine Impact Burial, Hydrodynamics, IMPACT35, Bottom Mine, Mine Countermeasures, Mine Trajectory			15. NUMBER OF PAGES 322	
			16. PRICE CODE	
17. SECURITY CLASSIFICATION OF REPORT Unclassified	18. SECURITY CLASSIFICATION OF THIS PAGE Unclassified	19. SECURITY CLASSIFICATION OF ABSTRACT Unclassified	20. LIMITATION OF ABSTRACT UL	

NSN 7540-01-280-5500

Standard Form 298 (Rev. 2-89)
Prescribed by ANSI Std. Z39-18

THIS PAGE INTENTIONALLY LEFT BLANK

Approved for public release, distribution is unlimited.

**MINE DROP EXPERIMENT II WITH OPERATIONAL MINESHAPES
(MIDEX II)**

Charles R. Allen
Lieutenant, United States Navy
B.S., The Ohio State University, 1999

Submitted in partial fulfillment of the
requirements for the degree of

**MASTER OF SCIENCE IN
METEOROLOGY AND PHYSICAL OCEANOGRAPHY**

from the

**NAVAL POSTGRADUATE SCHOOL
March 2006**

Author: Charles R. Allen

Approved by: Peter Chu
Thesis Advisor

Peter Fleischer
Second Reader

Mary L. Batteen
Chairman, Department of Oceanography

THIS PAGE INTENTIONALLY LEFT BLANK

ABSTRACT

The Navy's Impact Burial Model (IMPACT35) predicts the cylindrical mine trajectory in air and water columns and burial depth and orientation in sediment. Impact burial calculations are derived primarily from the sediment characteristics and from the mine's three-dimensional air and water phase trajectories. Accurate burial prediction requires that the model's water phase trajectory reasonably mimics the object's true trajectory. In order to determine what effect varying the shape to more closely match real-world mines has on the shape's water phase trajectory, Mine Drop Experiment II was conducted. The experiment consisted of dropping four separate types of scaled shapes (Sphere, Gumdrop, Manta, and Rockan) into a water column, and the resultant falls were filmed from two nearly orthogonal angles. Initial drop position, initial velocities, and the drop angle were controlled parameters. Observed trajectories were highly variable, but several broad conclusions were reached. The Sphere and Gumdrop shapes tended to have smooth arcing drop paths, however the denser Gumdrop shape had the fastest and straightest drops overall to 2.5 m depth. The Manta shape dropped much more slowly than the Sphere or Gumdrop shapes. The Manta had a tendency to either fall in a spiral with its bottom parallel to the bottom or on its side in a twisting motion. The Rockan tended to either flip or swoop as it entered the water but then tended to settle in a slow spin with its primary length parallel to the bottom. The dispersion of all four shapes on the X-Y plane at the selected depth of 2.5 m was wide and variable. The data collected from the experiment can be used to develop and validate the mine Impact Burial Prediction Model with operational, non-cylindrical mine shapes.

THIS PAGE INTENTIONALLY LEFT BLANK

TABLE OF CONTENTS

I.	INTRODUCTION.....	1
II.	HYDRODYNAMICS OF RIGID BODY MOVEMENT IN FLUIDS.....	7
	A. TRIPLE COORDINATE SYSTEMS	7
	B. MOMENTUM BALANCE	11
	C. MOMENT OF MOMENTUM EQUATION.....	12
III.	MINE DROP EXPERIMENT II.....	15
	A. PREPARATION	15
	1. Overview	15
	2. Shapes.....	15
	3. Release Mechanism.....	22
	4. Test Tank	22
	5. Cameras and Data Collection Equipment	24
	B. METHODOLOGY	26
	1. Overview	26
	2. Camera Calibration	26
	3. Experimental Procedure	27
IV.	DATA RETRIEVAL AND ANALYSIS.....	29
	A. DATA RETRIEVAL	29
	B. DATA ANALYSIS.....	31
V.	RESULTS	35
	A. TRAJECTORY PATTERNS.....	35
	B. FINAL POSITION PLOT.....	42
VI.	DISCUSSION.....	43
	A. SHAPE TRAJECTORIES	43
	B. IMPACT POINT TENDENCIES.....	44
	C. SCALING CONCERNS.....	45
	D. SOURCES OF ERROR.....	46
VII.	CONCLUSIONS	49
APPENDIX A.	MINE TRAJECTORIES.....	51
APPENDIX B.	FINAL POSITIONS	103
APPENDIX C.	NUMERICAL DATA	105
APPENDIX D.	SAMPLE MATLAB FILE FOR DATA ANALYSIS	297
	LIST OF REFERENCES.....	301
	INITIAL DISTRIBUTION LIST	305

THIS PAGE INTENTIONALLY LEFT BLANK

LIST OF FIGURES

Figure 1.	Depth Regimes for Littoral Mine Warfare (After MWP, 2006).....	2
Figure 2.	Manta Bottom Mine (From Brown, 2006).....	4
Figure 3.	Rockan Bottom Mine (From Brown, 2006).....	6
Figure 4a.	M-coordinate with the COM as the origin \mathbf{X} and $(\mathbf{i}_m, \mathbf{j}_m)$ as the two axes. Here, χ is the distance between the COV (B) and COM, (L, d) are the shape's length and diameter.....	7
Figure 4b.	M-coordinate with the COM as the origin \mathbf{X} and $(\mathbf{i}_m, \mathbf{j}_m)$ as the two axes. Here, χ is the distance between the COV (B) and COM, (L, d) are the shape's length and diameter.....	8
Figure 5.	Three coordinate systems for Manta shape.....	9
Figure 6.	Three coordinate systems for Rockan shape.....	10
Figure 7.	Diagram of Sphere Shaped Model Mine.	18
Figure 8.	Finished Sphere Shaped Model Mine.	18
Figure 9.	Diagram of Gumdrop Shaped Model Mine.	19
Figure 10.	Finished Gumdrop Shaped Model Mine.....	19
Figure 11.	Diagram of Manta Shaped Model Mine.	20
Figure 12.	Finished Manta Shaped Model Mine.....	20
Figure 13.	Diagram of Rockan Shaped Model Mine.	21
Figure 14.	Finished Rockan Shaped Model Mine.....	21
Figure 15.	Release Board Mounted on Moveable Bridge.	22
Figure 16.	MBARI Test Tank Facility (Structure Above Water is Moveable Bridge).....	23
Figure 17.	MIDEX II Tank Set Up Top View.	23
Figure 18.	View from Underwater Viewing Window.....	24
Figure 19.	Photron FASTCAM PCI digital camera.	26
Figure 20.	Diagram of Calibration Test Cross.	27
Figure 21.	Examples of High Speed Film Frames.	30
Figure 22.	MAXTRAQ analysis software screenshots.	31
Figure 23.	Sample X-Z/Y-Z Trajectory Plot.....	32
Figure 24.	Sample X-Y-Z Trajectory Plot.....	33
Figure 25.	Final Position Data Point Sample.	34
Figure 26.	Sphere/Gumdrop Trajectory Examples.....	37
Figure 27.	Manta Trajectory Examples.....	38
Figure 28.	Rockan Trajectory Examples.....	39
Figure 29.	Final Position Plot (All Shapes). Sphere Drop Points are indicated by Red Stars. Gumdrop Drop Points are indicated by Blue Circles. Manta Drop Points are indicated by Green Hexagons. Rockan Drop Points are indicated by Black Squares.....	42
Figure 30.	Drag Coefficient vs. Reynolds Number for Flow Around a Circular Disk (After Gefken, 2005).....	46

THIS PAGE INTENTIONALLY LEFT BLANK

LIST OF TABLES

Table 1.	Physical parameters of Manta mines (After Knudsen, 2004).....	5
Table 2.	Physical parameters of Rockan mines (After Knudsen, 2004).....	6
Table 3.	Mine Shape Measurements.....	16
Table 4.	Sphere and Gumdrop Trajectory Patterns.....	35
Table 5.	Manta Trajectory Patterns.....	35
Table 6.	Rockan Trajectory Patterns.....	36
Table 7.	Sphere Results.....	40
Table 8.	Gumdrop Results.....	40
Table 9.	Manta Results.....	41
Table 10.	Rockan Results.....	41
Table 11.	Trajectory Probabilities for All Shapes.....	44

THIS PAGE INTENTIONALLY LEFT BLANK

ACKNOWLEDGMENTS

The author gratefully acknowledges the financial support of the Naval Oceanographic Office (contract number: N6230604PO00123) and Office of Naval Research (grant number: N0001405WR20052). I would like to acknowledge and thank Professor Peter Chu for his guidance and patience. Many special thanks go to the people who assisted the author, including Bill Bellingham and Thomas Hoover at the Monterey Bay Aquarium Research Institute, Chris Balch for usage of the high-speed cameras and image capture software, Manfred Berger for the MAXTRAQ software used to analyze shape motion, and Fan Chenwu for his superlative MATLAB expertise. A final thanks goes to LT Gregory Ray, with whom the author collaborated to complete two different thesis experiments at the same time.

THIS PAGE INTENTIONALLY LEFT BLANK

I. INTRODUCTION

The end of the Cold War marked a shift for the U.S. Navy from a “blue” water, anti-Soviet focus, towards a concentration on the regional littoral threats of the world. With the increasing number of regional and asymmetric threats, the Navy must operate effectively and safely in near-shore waters. A grave threat in this operating theater is the sea mine.

Though mines have been part of naval warfare since ancient Greece, they have challenged U.S. naval power for over 200 years. Due to their low cost, ease of deployment, and uncompromised effectiveness, mines are a highly sought force multiplier. Whether used offensively to mine enemy harbors or shipping lanes or defensively against amphibious assaults, mines can deal large amounts of damage for minimal cost and no loss of life for those employing them. Since 1946, at least 14 U.S. ships, including two in the first Gulf War, have been damaged or sunk by small-scale mining operations. An Iranian SADAQ-02 contact mine, costing only \$1500, hit and nearly sank the *Samuel B. Roberts* (FFG-58) in 1988, costing almost \$96 million in damages (Mine Warfare Plan, 2006).

Today at least 45 countries (including the United States and countries comprising the former Soviet Union) possess mining capability, and many more nations can acquire that capability very quickly. Over 20 countries produce mines, and 13 are confirmed mine exporters. In addition, an unknown threat exists as virtually any country or properly funded terrorist organization can effectively produce a mine (Baciocco, 1997).

Mines do not have to be of the latest technology to be a credible threat to naval operations. Some mines in the Iranian inventory are refurbished and upgraded ones from the Russo-Japanese War of 1904-05! A new microprocessor triggering control placed in an old mine can upgrade obsolescent mines at a cost even lower than that of a new mine (Baciocco, 1997).

Though mines can be inexpensive yet dangerous, effective mine countermeasures (MCM) can be both costly and difficult due to increasing sophistication of fusing

methods and the reduction of mine signatures via sonar. High tech processing allows more complex magnetic, pressure, and acoustic triggering that can evade current sweeping techniques. Since the Korean Conflict, explosive charge carried in an average mine has almost doubled, increasing the radius of damage. Yet its electronics section has been reduced by 20% (Baciocco, 1997).

Significant challenges still remain in the surveillance, reconnaissance, detection, and neutralization of mines. The sheer variety of the mine threat does not allow a single solution in the MCM equation. The primary challenge is to determine exactly where the waiting mines are located, and the primary factor that can ease or hinder the search for those mines is the bathymetric character of the sea bottom. High bottom clutter including rock outcroppings, coral reefs, or man-made debris or structures, gives many false alarms or shadow zones that increase overall MCM clearance times. Figure 1 shows the many depths and types of mines used in the littoral environment.

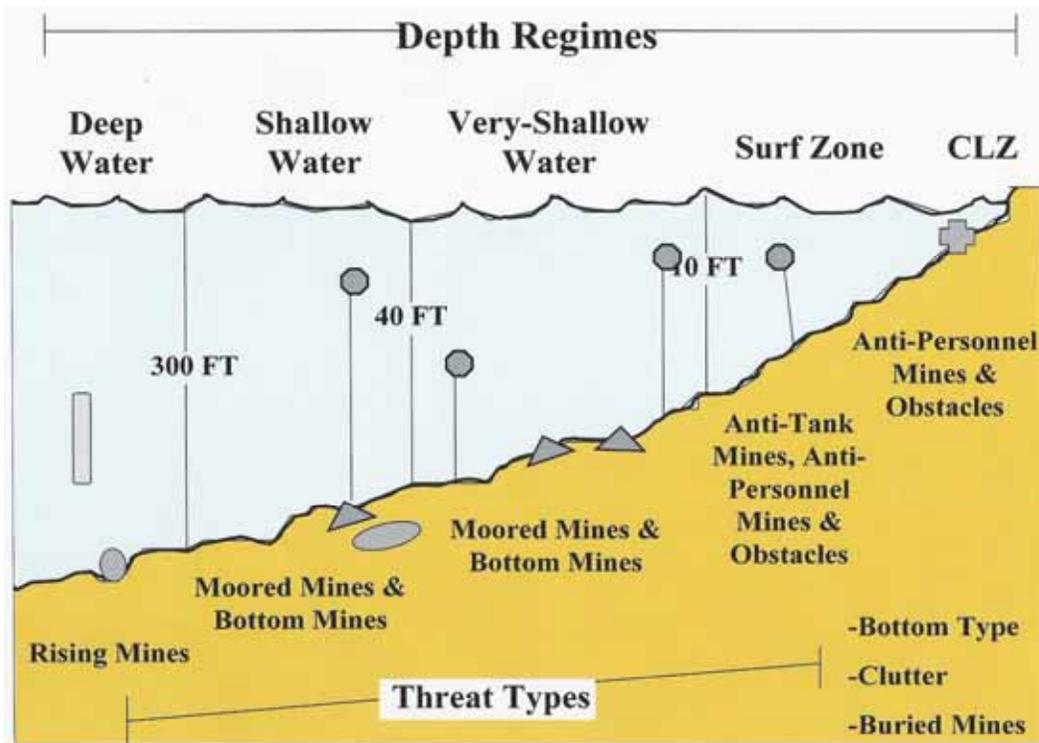

Figure 1. Depth Regimes for Littoral Mine Warfare (After MWP, 2006).

Attempting to obtain accurate data of potential enemy shores, however, may not be easy, so MCM plans must account for this uncertainty. Models used to formulate impact burial (IB) sites of dropped bottom mines have thus been developed to counter that uncertainty. Using those models, the planner can, when knowing the release position of the mine above the surface, predict the mine's vertical position in the air and water to ultimately determine the burial depth in the sea sediment.

The one-dimensional Impact Burial Prediction Model (IBPM), developed by Arnone and Bowen in 1980, was able to predict the vertical position of a cylindrical mine's center of mass (COM) through air, water, and sediment. The burial depth was based on the mine's velocity at sediment depth as well as the properties of the sediment. Satkowiak (1988) added additional modeling and mathematical complexity, but the major weakness of the one-dimensional model, the assumption of a constant mine orientation as it falls, remained.

Two-dimensional models were developed to overcome this limitation (Hurst, 1992). The two versions, IMPACT 25 (written in BASIC) and IMPACT 28 (written in BASIC and Matlab), contained two momentum equations (in x- and z-directions) and a moment of momentum equation (in the y-direction). Thus it was able to predict the mine's COM position in the x-z plane and the rotation about the y-axis. Sensitivity studies on the two-dimensional model (Taber, 1999) indicated that mine burial depth was not affected by the mine releasing height. Another experiment in Monterey Bay (Chu et al., 2004b-c; 2005a-d) showed IMPACT 25 over-predicted burial depth. The primary weakness of the two-dimensional model, however, was that it was very difficult to include fluid motion, as any fluid motion in the y-axis broke the two-dimensional plane.

The latest IBPM is IMPACT 35. With full physics, the model contains three momentum equations and three momentum equations, predicting the mine's COM position in (x, y, z) space and the rotation around all three axes (Chu et al., 2002a-b; 2003; 2004a). Testing and evaluation of IMPACT 25 and IMPACT 35 at the Naval Surface Warfare Center-Carverock, Corpus Christi, and the Baltic Sea (Valent et al., 2002; Holland et al., 2004; Elmore et al., 2004) have shown significant improvement of three-dimensional modeling over two-dimensional modeling.

The main limitation of the current iteration of IMPACT 35 is its utilization for cylindrical mines only. The effect of shape is a significant issue if the model is to be used operationally, as the most widely used bottom mines such as the Manta and the Rockan are not cylindrical. Determination of the hydrodynamic force and torque for non-cylindrical mines is crucial, but there are no existing formulae for these. Conformal projection may be used to transfer a non-cylindrical mine into an equivalent cylindrical mine, with chaotic features being handled with instability and predictability analyses.

Overcoming IMPACT 35's weakness requires test data involving various shapes. MIDEX II, conducted in September 2005, is the direct continuation of this testing and data gathering process. In that experiment, the overall shape of the mine was varied from the IMPACT 35 cylinder to see how the water phase trajectory would be affected. In addition to a Sphere and semi-hemispherical "Gumdrop" shape, two shapes were specifically chosen to represent real world bottom mines: the Manta and Rockan.

The Manta (Figure 2) is an anti-invasion bottom mine, produced primarily by the Italian firm Whitehead Alenia. It is shaped as a truncated cone with a glass reinforced plastic (GRP) casing, triggered either acoustically or magnetically. The Manta has a shelf life of 30 years and will operate for 17 months after activation. Table 1 shows the physical parameters of Manta mines.



Figure 2. Manta Bottom Mine (From Brown, 2006).

Diameter:	0.980 m
Height:	0.440 m
Weight:	220 kg
Charge:	130 kg (HBX-3)
Operating Depth:	3-100 m

Table 1. Physical parameters of Manta mines (After Knudsen, 2004).

Sweden's acoustic and magnetic BGM-100 Rockan mine (Figure 3) has a gliding shape which allows mine-laying over a wide area while covering the minimal distance; its low-profile stealth shape makes it difficult to detect. Its casing is also constructed of GRP. Both the Manta and Rockan are made even stealthier by having anechoic coatings and being made of nonferrous materials to reduce the mines' acoustic and magnetic signatures. Table 2 shows the physical parameters of Rockan mines.



Figure 3. Rockan Bottom Mine (From Brown, 2006).

Length:	1.015 m
Width:	0.800 m
Height:	0.385 m
Weight:	190 kg
Charge:	105 kg (Cemtex)
Operating Depth:	105 kg

Table 2. Physical parameters of Rockan mines (After Knudsen, 2004).

II. HYDRODYNAMICS OF RIGID BODY MOVEMENT IN FLUIDS

Study on the movement of a rigid body in fluid has wide scientific significance and technical application. It involves nonlinear dynamics, flight theory, body-fluid interaction, and instability theory (von Mises, 1959). Prediction of a falling rigid body in the water column is a key component in determining the impact speed and direction of mine on the sediment and in turn in determining its burial depth and orientation.

A. TRIPLE COORDINATE SYSTEMS

Consider two three-dimensional shapes based on the Manta and Rockan mines with the center of mass (COM) \mathbf{X} and center of volume (COV) \mathbf{B} on the main axis (Figures 4a and 4b). Let (L, d, χ) represent the mine's length, width, and the distance between the two points (\mathbf{X}, \mathbf{B}). The positive χ -values refer to nose-down case, i.e., the point \mathbf{X} is lower than the point \mathbf{B} . Three coordinate systems are used to model the falling shape through the air, water, and sediment phases: earth-fixed coordinate (E-coordinate), main-axis following coordinate (M-coordinate), and force following coordinate (F-coordinate) systems. All the systems are three-dimensional, orthogonal, and right-handed. The origin of M- and F-coordinates is located at \mathbf{X} (Chu et al., 2004a).

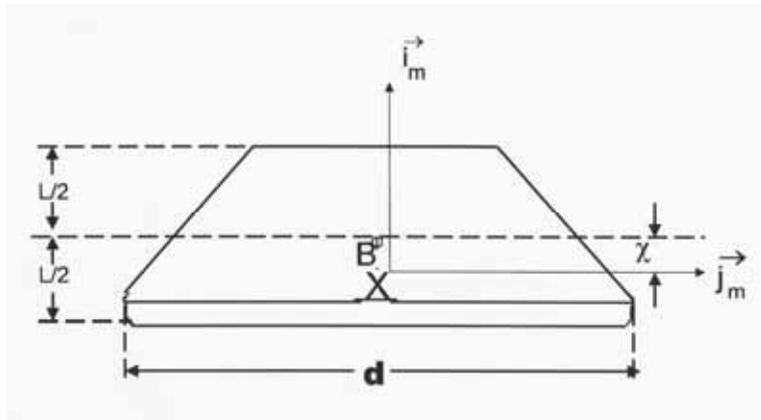

Figure 4a. M-coordinate with the COM as the origin \mathbf{X} and (i_m, j_m) as the two axes. Here, χ is the distance between the COV (\mathbf{B}) and COM, (L, d) are the shape's length and diameter.

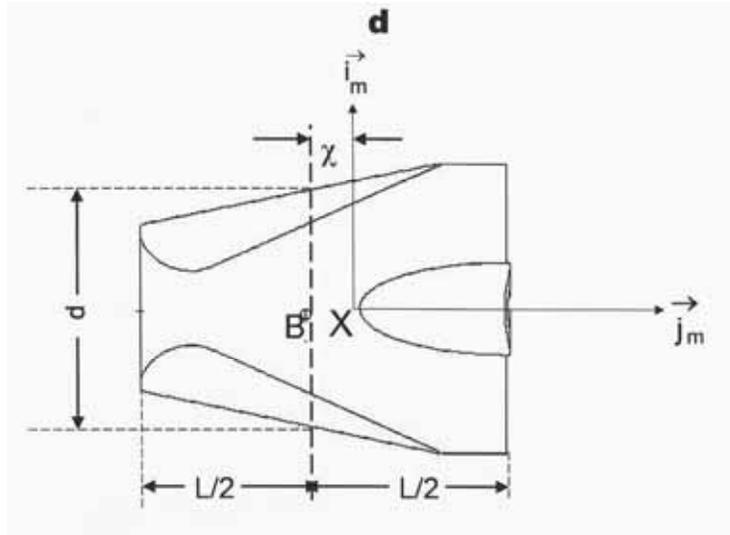

Figure 4b. M-coordinate with the COM as the origin X and (i_m, j_m) as the two axes. Here, χ is the distance between the COV (B) and COM, (L, d) are the shape's length and diameter.

The E-coordinate is represented by $F_E(O, i, j, k)$ with the origin 'O', and three axes: x -, y - axes (horizontal) with the unit vectors (i, j) and z -axis (vertical) with the unit vector k (upward positive) (see Figures 5 and 6). The position of the shape is represented by the COM position,

$$\mathbf{X} = xi + yj + zk. \quad (1)$$

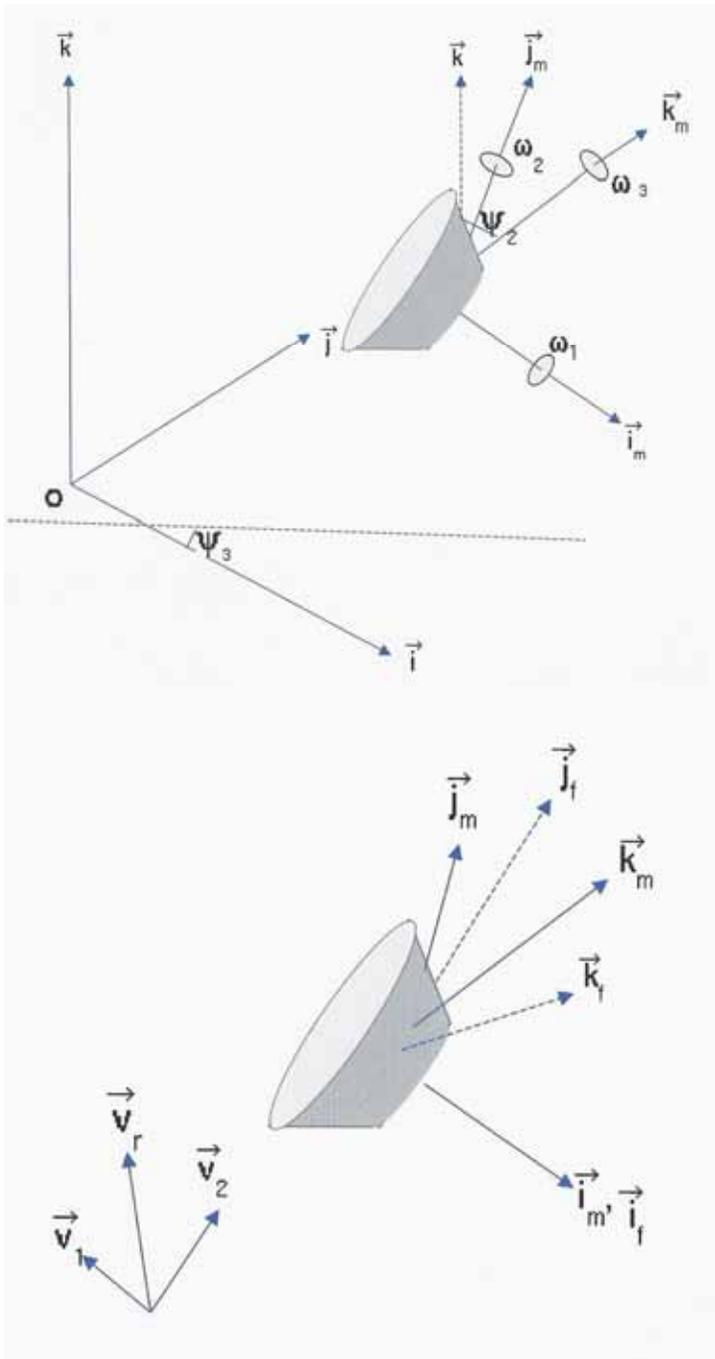

Figure 5. Three coordinate systems for Manta shape.

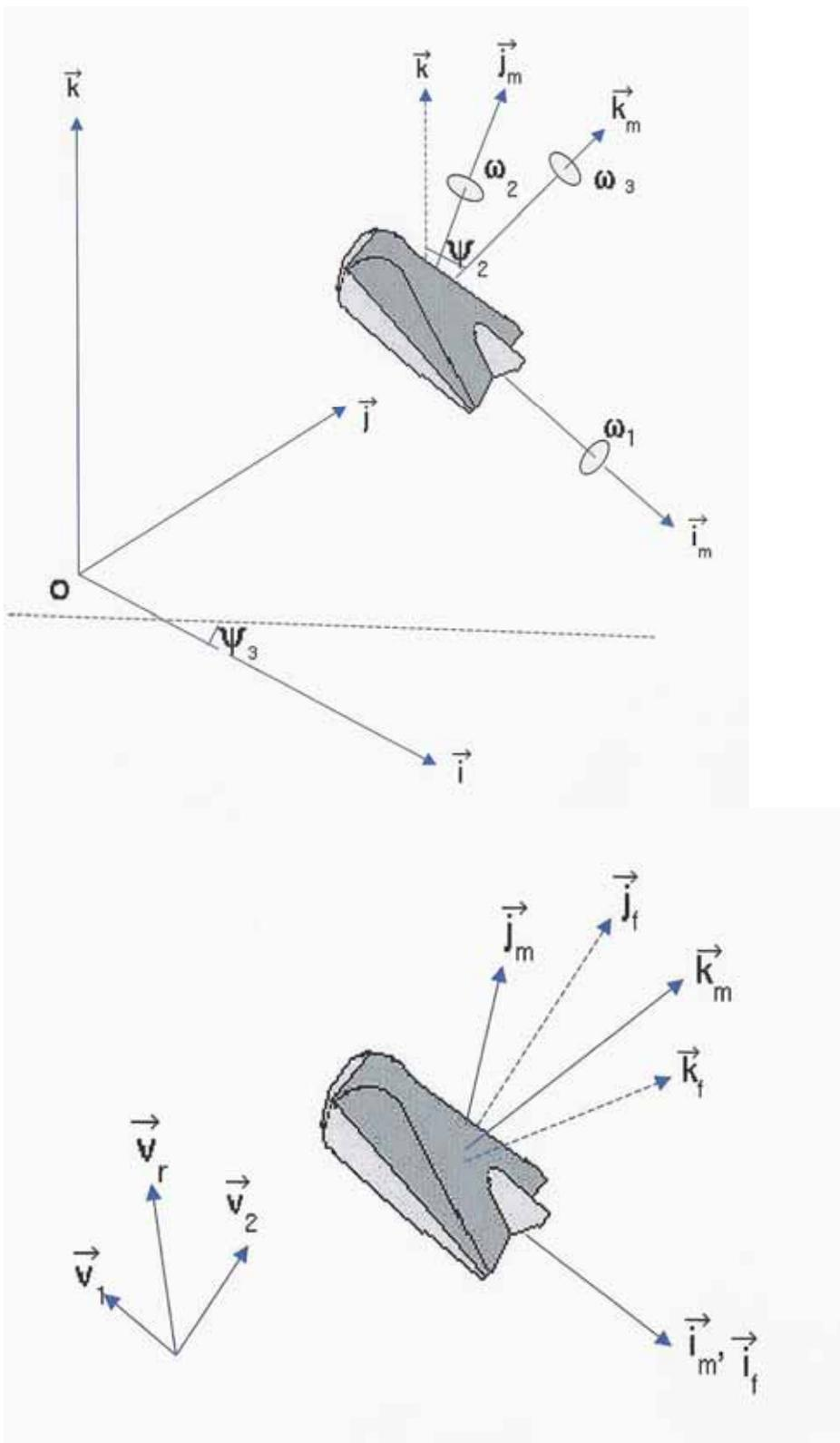

Figure 6. Three coordinate systems for Rockan shape.

The translation velocity is given by

$$\frac{d\mathbf{X}}{dt} = \mathbf{V}, \quad \mathbf{V} = (u, v, w). \quad (2)$$

The orientation of the mine's main-axis (pointing downward) is given by \mathbf{i}_M . The angle between \mathbf{i}_M and \mathbf{k} is denoted by $\psi_2 + \pi/2$. Projection of the vector \mathbf{i}_M onto the (x, y) plane creates angle (ψ_3) between the projection and the x -axis (Figures 5 and 6). The M-coordinate is represented by $F_M(\mathbf{X}, \mathbf{i}_M, \mathbf{j}_M, \mathbf{k}_M)$ with the origin 'X', unit vectors ($\mathbf{i}_M, \mathbf{j}_M, \mathbf{k}_M$), and coordinates (x_M, y_M, z_M) . The M-coordinate system is solely determined by the orientation of the mine's main-axis \mathbf{i}_M . The unit vectors of the M-coordinate system are given by (Figures 5 and 6)

$$\mathbf{j}_M = \mathbf{k} \times \mathbf{i}_M, \quad \mathbf{k}_M = \mathbf{i}_M \times \mathbf{j}_M \quad (3)$$

The F-coordinate is represented by $F_F(\mathbf{X}, \mathbf{i}_F, \mathbf{j}_F, \mathbf{k}_F)$ with the origin X, unit vectors ($\mathbf{i}_F, \mathbf{j}_F, \mathbf{k}_F$), and coordinates (x_F, y_F, z_F) . Let \mathbf{V}_w be the fluid velocity. The water-to-shape velocity is represented by

$$\mathbf{V}_r = \mathbf{V}_w - \mathbf{V}, \quad (4) \text{ which can be decomposed into two}$$

parts,

$$\mathbf{V}_r = \mathbf{V}_1 + \mathbf{V}_2, \quad \mathbf{V}_1 = (\mathbf{V}_r \cdot \mathbf{i}_F) \mathbf{i}_F, \quad \mathbf{V}_2 = \mathbf{V}_r - (\mathbf{V}_r \cdot \mathbf{i}_F) \mathbf{i}_F, \quad (5)$$

where \mathbf{V}_1 is the component parallel to the shape's main-axis (i.e., along \mathbf{i}_M), and \mathbf{V}_2 is the component perpendicular to the shape's main-axial direction. The unit vectors for the F-coordinate are defined by (column vectors)

$$\mathbf{i}_F = \mathbf{i}_M, \quad \mathbf{j}_F = \mathbf{V}_2 / |\mathbf{V}_2|, \quad \mathbf{k}_F = \mathbf{i}_F \times \mathbf{j}_F. \quad (6) \text{ In the F-coordinate,}$$

the hydrodynamic forces (drag, lift) and torques are easily computed ([5] White 1974; [6] Crowe et al., 2001).

B. MOMENTUM BALANCE

The translation velocity of the shape (\mathbf{V}) is governed by the momentum equation in the E-coordinate system (von Mises, 1959)

$$\frac{d}{dt} \begin{bmatrix} u \\ v \\ w \end{bmatrix} = - \begin{bmatrix} 0 \\ 0 \\ g \end{bmatrix} + \frac{\mathbf{F}_b + \mathbf{F}_h}{\rho\Pi}, \quad (7)$$

where g is the gravitational acceleration; Π is the shape volume; ρ is the rigid body density; $\rho\Pi = m$, is the shape mass; \mathbf{F}_h is the hydrodynamic force (i.e., surface force including drag, lift, impact forces); $\mathbf{F}_b = -\rho_w\Pi\mathbf{g}$, is the buoyancy force; and ρ_w is the water density. The drag and lift forces are calculated using the drag and lift laws with the given water-to-shape velocity (\mathbf{V}_r). In the F-coordinate, \mathbf{V}_r is decomposed into along-shape (\mathbf{V}_1) and across-shape (\mathbf{V}_2) components.

C. MOMENT OF MOMENTUM EQUATION

It is convenient to write the moment of momentum equation (von Mises, 1959)

$$\mathbf{J} \bullet \frac{d\boldsymbol{\omega}}{dt} = \mathbf{M}_b + \mathbf{M}_h, \quad (8)$$

in the M-coordinate system with the shape's angular velocity components ($\omega_1, \omega_2, \omega_3$) defined by (4). Here, \mathbf{M}_b and \mathbf{M}_h are the buoyancy and hydrodynamic force torques. The buoyancy force induces the moment in the \mathbf{j}_M direction if the COM doesn't coincide with the COV (i.e., $\chi \neq 0$),

$$\mathbf{M}_b = \Pi\chi\rho_w g \cos\psi_2 \mathbf{j}_M. \quad (9)$$

The hydrodynamic force (\mathbf{F}_h) and torque (\mathbf{M}_h) are easily calculated in the F-coordinate system using existing formulas. After calculation, the hydrodynamic force (\mathbf{F}_h) should be transformed from the F-coordinate to the E-coordinate before substituting into the momentum equation (7), and the hydrodynamic torque (\mathbf{M}_h) should be transformed from the F-coordinate to the M-coordinate before substituting into the moment of momentum equation (8) for solutions (Chu et al. 2004a-b). To compute the hydrodynamic force (\mathbf{F}_h) and torque (\mathbf{M}_h), the drag and lift coefficients should be given. For spherical and cylindrical mines, these coefficients can be computed using Reynolds

number dependent semi-empirical formulae (Chu et al., 2005c). However, for the operational mine shapes such as Manta or Rockan, there are no such mathematical expressions to use. In this thesis, a Mine Drop Experiment was conducted with operational mine shapes.

THIS PAGE INTENTIONALLY LEFT BLANK

III. MINE DROP EXPERIMENT II

A. PREPARATION

1. Overview

The overall objective of the experiment, conducted during 12–16 September 2005, was the collection of trajectory data from each of four mine-like shapes. Each shape was dropped just above the surface of the water and filmed with a pair of high-speed cameras as the shape fell through the water column. Each trajectory was then converted to an array of Cartesian coordinates and analyzed with software specifically designed to work with the high-speed cameras.

2. Shapes

Mine shapes were selected based upon current and future operational relevance. A collection of four mine-like polyester resin test shapes was used during the experiment phase of the project. These shapes consisted of a Sphere, a semi-hemispherical “Gumdrop” shape, a scale model of the Manta bottom mine, and a scale model of the Rockan bottom mine. The Sphere was selected to serve as a “calibration” shape because its shape symmetry and equal weight distribution about its three axes. The Gumdrop was similar in shape to but higher in density than the Sphere. The Gumdrop was selected to act as a kind of “traditional” shape of bottom sea mines, though no mine was specifically represented.

The construction of the test shapes consisted of a three-part production process: prototype development, mold construction and test shape casting and finishing. This process was necessary to facilitate more efficient experimentation and to reduce the production cost of the experimental test shapes.

Prototype production for all the shapes except the sphere began by taking solid blocks of plaster of Paris and machining the shapes to the properly scaled dimensions and characteristics based on available mine blueprints. Only the shapes of the mines were

duplicated, not the internal workings or functions. The sphere prototype was a solid rubber ball with a diameter appropriate to the scale of the other shapes (Table 3).

Model	Description	Mass	Density	Dimensions	
Model 1	Generic Sphere Shape	1692.0 g	1.335 g/cm ³	D: Scale: Distance from COM to COV:	13.0 cm N/A 0 cm
Model 2	Gumdrop Hemispherical Shape	2815.0 g	1.722 g/cm ³	D: H: Scale: Distance from COM to COV:	14.9 cm 13.3 cm N/A 0 cm
Model 3	Manta Bottom Influence Mine Shape	1145.0 g	1.615 g/cm ³	D(Bottom): D(Top): H: Scale: Distance from COM to COV:	15.0 cm 7.0 cm 6.2 cm 1/6 + 0.373 cm Z-axis
Model 4	Rockan Bottom Influence Mine Shape	813.0 g	1.388 g/cm ³	L: W(Back): W(Front): H(Back): H(Front): Scale: Distance from COM to COV:	16.0 cm 7.8 cm 13.3 cm 6.3 cm 3.8 cm 1/6 0 cm

Table 3. Mine Shape Measurements.

Once prototype construction was complete, work began on making casting molds of the prototypes from which the final experimental shapes could be produced. Mold production was identical for all four shapes. The mold making process consisted of making two separate mold halves for a given shape. To create the first half of the mold, a cardboard container was constructed to hold the shape and the molding materials. This container was sealed at all joints, and then filled 2/3 with sand. On top of the sand, a layer of modeling clay was packed and smoothed in the container. The prototype shape was then depressed half way into the clay along its long axis leaving the remaining half of the shape exposed. To facilitate simple removal from the final mold, the exposed

portion of the shape, clay and interior of the container were coated with a silicon release agent. After all preparations were complete, the remainder of the box was filled with commercially available liquid urethane rubber molding compound and allowed to cure overnight. It is also worth noting that the particular type of urethane rubber used is of the sort that did not require vacuum degassing to remove bubbles. When the rubber was cured into its final state, the completed mold-half was removed from the container. To create the second half of the mold, the process was repeated, but instead of using sand and clay to support the prototype, the newly created mold half was utilized. After the entire mold was complete, holes were placed in the ends of the mold to facilitate resin insertion and the evacuation of air as the casting material entered the mold. This process was repeated for all remaining prototype test shapes.

The final step in the production of the testing shapes consisted of pouring and finishing the numerous uniform-density polyester resin castings created from the prototype molds. The castings were created from commercially available, two-part, ultra-low viscosity, rigid, urethane casting resin, which readily accepts coloring and density additives and yielded virtually bubble-free castings without costly degassing procedures. As possibility of damage to the test facility and personnel was of paramount concern, the resin chosen possessed a shore hardness rating of 70D, which means that the shape would maintain dimensional integrity throughout the flight path, but still pose little risk of damage to the facility were it to impact the wall, window or floor of the test tank at high velocity. To facilitate creation of an accurately scaled model, all portions of the resin mixture were carefully measured and weighed, and fine brass powder was added to the resin during mixing to achieve the proper density ratio. Note: The densities of the Manta and Rockan shapes were based on the *average* densities of those mines. When all materials were prepared, the rubber mold was coated with silicone release agent, and closed using cloth straps. The resin mixture was then poured into the mold and allowed to cure overnight. When the casting was fully cured, the mold was carefully opened, and the final testing model removed from the mold. The models were allowed to cure an additional 48 hours prior to finishing. Finishing consisted of filling any imperfections with a slurry of polyester resin, followed by sanding and painting. A 150 g lead weight

was placed in the center bottom of the Manta shapes to make the center of gravity in the model more accurately represent the Manta mine's lower center of gravity. All models were painted with flat black spray enamel, and a series of white fiducials were added to aid in analysis of the digital video data. This process was repeated for each category of prototype so that at the time of experimentation, there were three testing models of each test shape available. Figures 7-14 detail the parameters of each model.

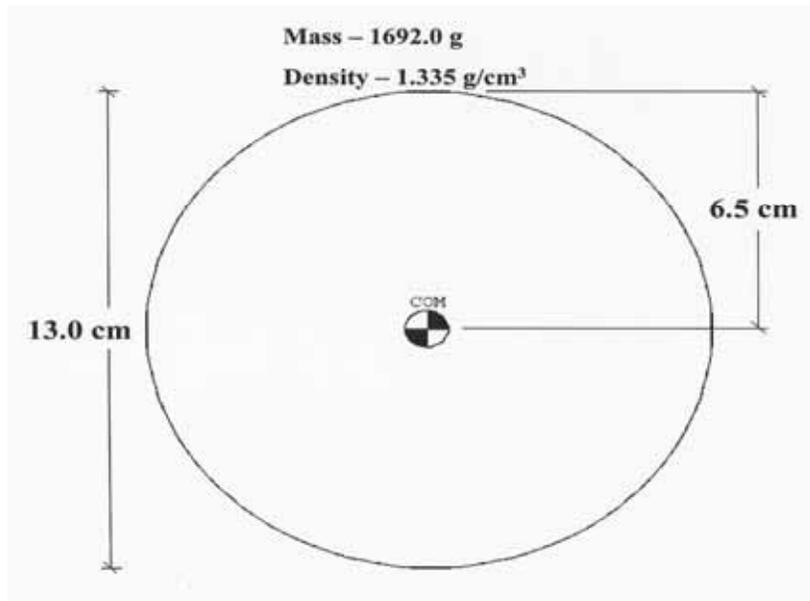

Figure 7. Diagram of Sphere Shaped Model Mine.



Figure 8. Finished Sphere Shaped Model Mine.

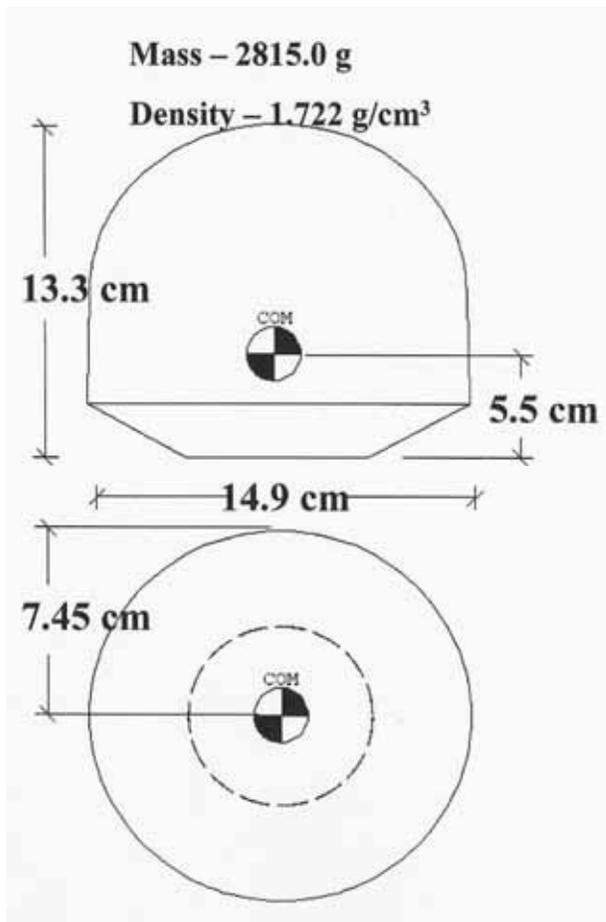

Figure 9. Diagram of Gumdrop Shaped Model Mine.



Figure 10. Finished Gumdrop Shaped Model Mine.

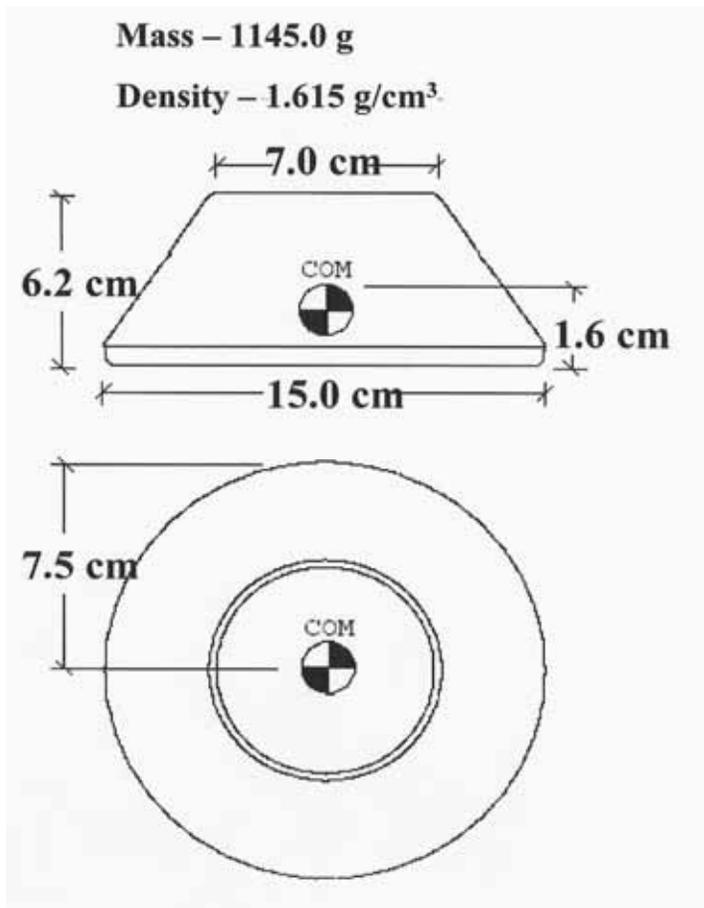

Figure 11. Diagram of Manta Shaped Model Mine.

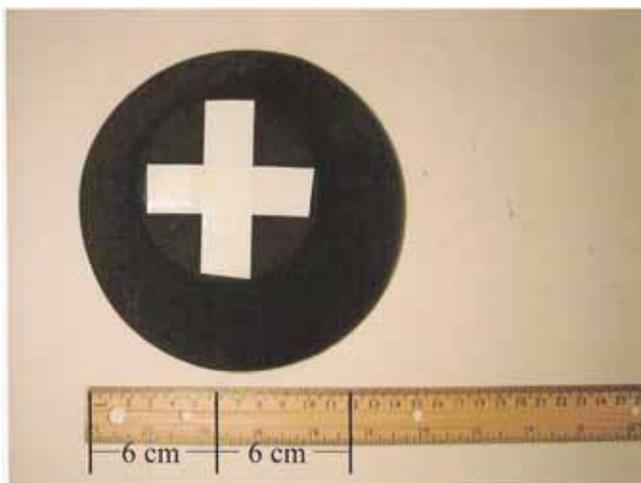

Figure 12. Finished Manta Shaped Model Mine.

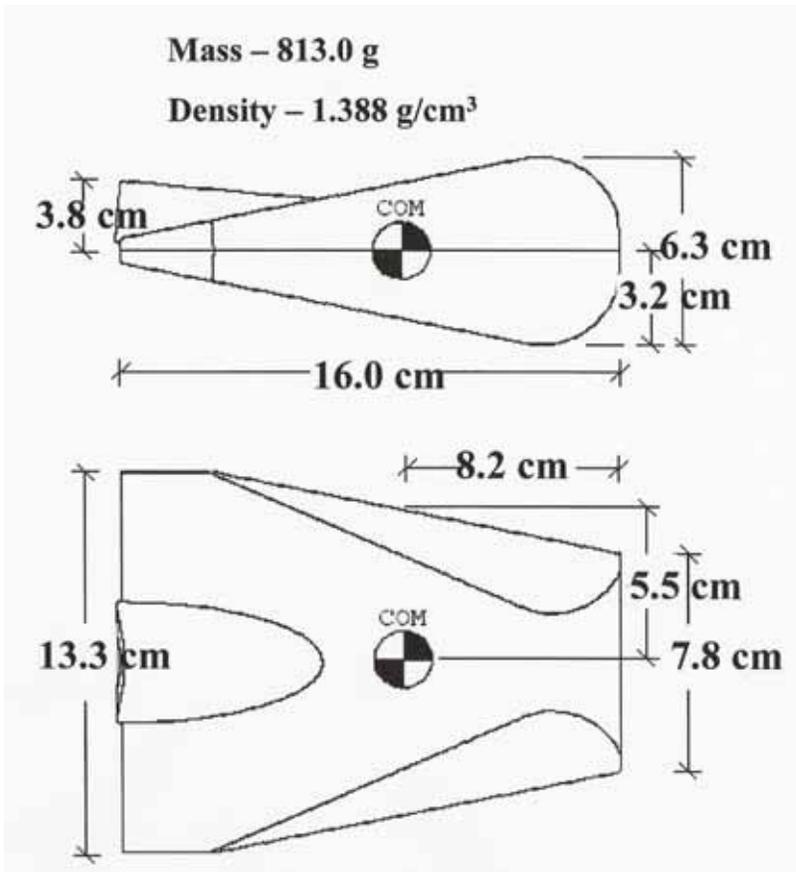

Figure 13. Diagram of Rockan Shaped Model Mine.

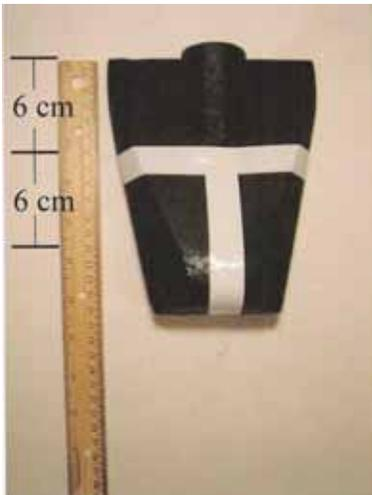

Figure 14. Finished Rockan Shaped Model Mine.

3. Release Mechanism

The drop phase of the experiment consisted of inserting each model into the water at one foot above the water on a nearly vertical slanted board (Figure 15) mounted to the moveable bridge and directly above the focal point of the cameras. When the mine shapes entered the water, they traveled vertically.

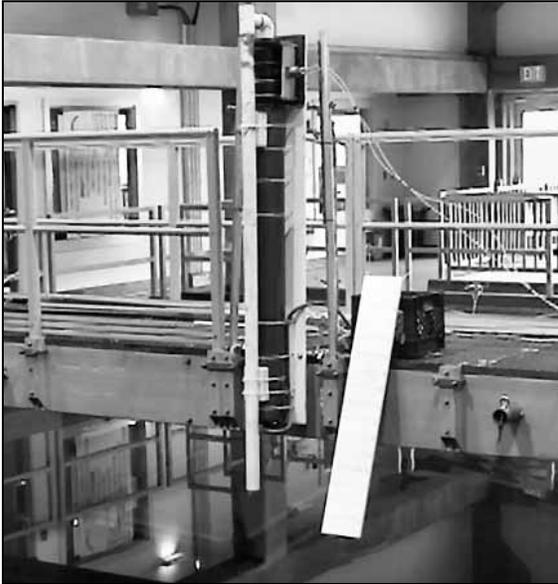

Figure 15. Release Board Mounted on Moveable Bridge.

4. Test Tank

MIDEX II was conducted at the Monterey Bay Aquarium Research Institute (MBARI) Unmanned Underwater Vehicle Test Tank (Figure 16). Enclosed inside a large building, this 10 m×15 m×10 m tank was filled with “standard sea water.” This water was maintained by an ozone filtration system, with no impurities save the remnants of blue dye placed into the tank several weeks prior to the experiment. The faint blue coloration had no effect on the shape trajectories, but it did add some difficulty illuminating the tank. Hence the video data quality was somewhat degraded. A sliding bridge, on which the slanted board was mounted, spanned the width of the tank.



Figure 16. MBARI Test Tank Facility (Structure Above Water is Moveable Bridge).

Figure 17 describes the measurements of the tank and placement of the drop zone, cameras, and lighting:

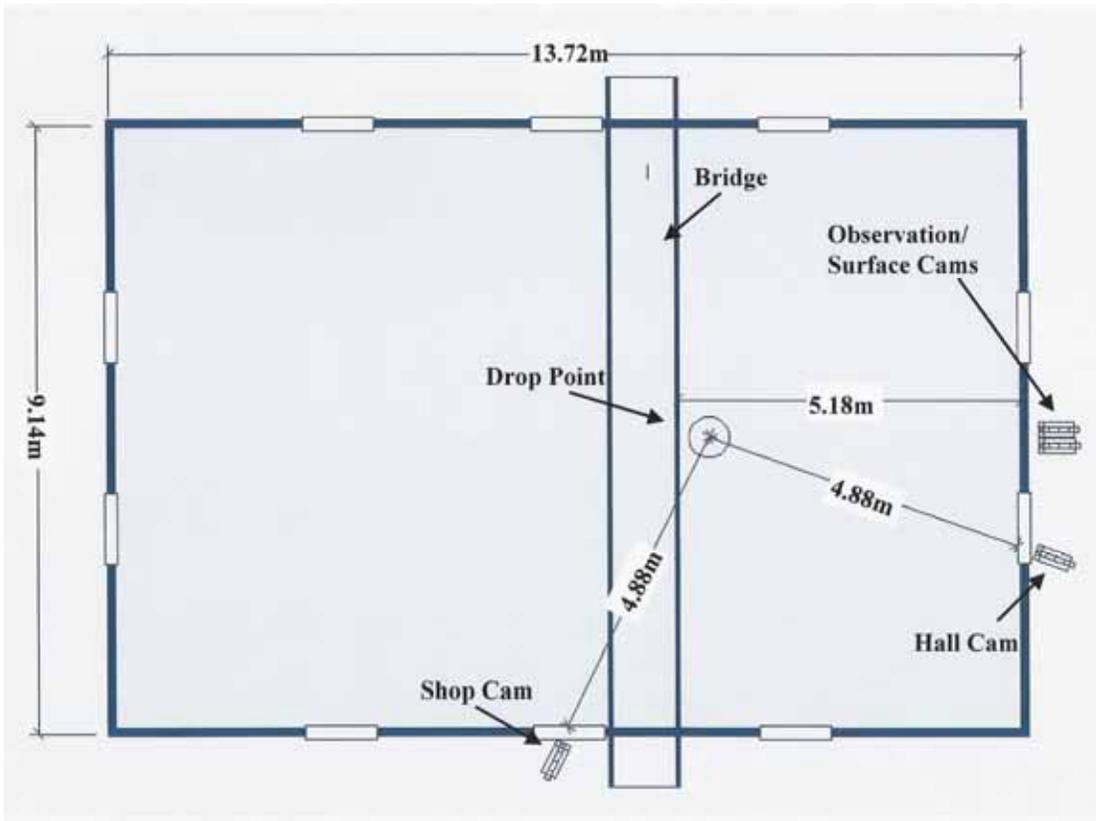

Figure 17. MIDEX II Tank Set Up Top View.

The tank was used to simulate the littoral operating environment with the scaled depth ranging to 54.9 m (180'), however the nature of the viewing windows only allows data collection to a scaled depth of roughly 18.29 m (60'). The tank has no current and no wind blowing over its surface. To aid in shape recovery, a 9 m×13 m two-centimeter netting was mounted to a constructed 1.9 cm diameter PVC piping horizontal grid and placed at the bottom of the tank out of camera view. At the end of a run, the net contained the shapes was retrieved using a series of pulleys placed at the four corners of the tank. Two large, dark blue 4.57 m×5.18 m tarpaulins were placed along the tank walls behind the camera views to assist the cameras and software with distinguishing the falling mine shapes from the tank background.

Eight viewing windows (as shown in Figure 18), as shown on the tank diagram, were 1.83 m (6 feet) below the surface of the water. The two viewing windows used were selected because of the unobstructed and near perpendicular view to the drop spot.



Figure18. View from Underwater Viewing Window.

5. Cameras and Data Collection Equipment

All data was collected digitally using a network of high-speed and standard video equipment and computers. Surface level information collected included experiment data and the video log. This data was collected using a pair of standard commercially available digital video camera, mounted on tripods, and located at the end of the pool

directly in front of the testing zone. Both top cameras operated at a 30 Hz frame rate. The data camera used a narrow view lens zoomed to focus on the area directly between the slanted board and the water surface, and was toggled on and off between test runs. The second camera used a wide-angle lens, and was employed to record a video log of the experiment. This device ran continuously throughout the experiment.

Subsurface video data, used to determine the trajectory of the falling shapes, was collected using a pair of high-speed, Photron FASTCAM PCI digital cameras (Figure 19). These cameras were mounted on tripods in two separate windows, at an angle of 70° in relation to one another so as to provide two, near orthogonal, views of the drop zone. After mounting and calibration, each camera station was covered with black plastic to block out any light source beside that which came from the field of view. The cameras were synchronized, calibrated and connected by a centrally located laptop computer via high-speed data cables. During testing the cameras were operated using the Photron FASTCAM Viewer software at 512×480 -pixel resolutions at full frame and recording rates of 125 Hz. To facilitate a wider field of view, both cameras were fitted with wide-angle lens. All data was recorded digitally on a standalone 200 GB hard drive during the test phase. Additionally, to enhance the quality of the data during testing, the installed tank lighting system was turned to its maximum setting and a pair of 1000-watt high intensity photography lights were mounted and used above the surface.



Figure 19. Photron FASTCAM PCI digital camera.

B. METHODOLOGY

1. Overview

The mine drop experiment consisted of releasing each shape vertically from 0.3 m (1 ft) above the surface of the water. The entry of each shape into the water was recorded by the two above-surface video cameras. All subsurface data collection was facilitated by the two FASTCAM PCI high-speed cameras. The subsurface digital data was analyzed by 3-D motion analysis software to determine the trajectories of each shape. All data from runs involving malfunctions was discarded. Overall, the Manta shape was successfully dropped 15 times, the Gumdrop 9, the Rockan 14, and the Sphere 13. Initial velocities of all shapes as they entered the water were calculated later using the MAXTRAQ motion analysis software.

2. Camera Calibration

Prior to the commencement of testing, calibration images were taken from each underwater camera view. This procedure provided an artificial frame of reference for use

by the analysis software in computing the shape's trajectory in the data retrieval phase. To accomplish this task, a geo-referenced calibration target consisting of a white, three-dimensional cross (Figure 20) was lowered into the camera's field of view to a depth of 250cm and filmed. The z-axis was determined by the vertical component of the cross, and the two horizontal components were used to acquire the x- and y-axes. Following acquisition of all calibration images, both cameras were secured to their final position and barricaded to prevent unwarranted disturbance during the testing phase.

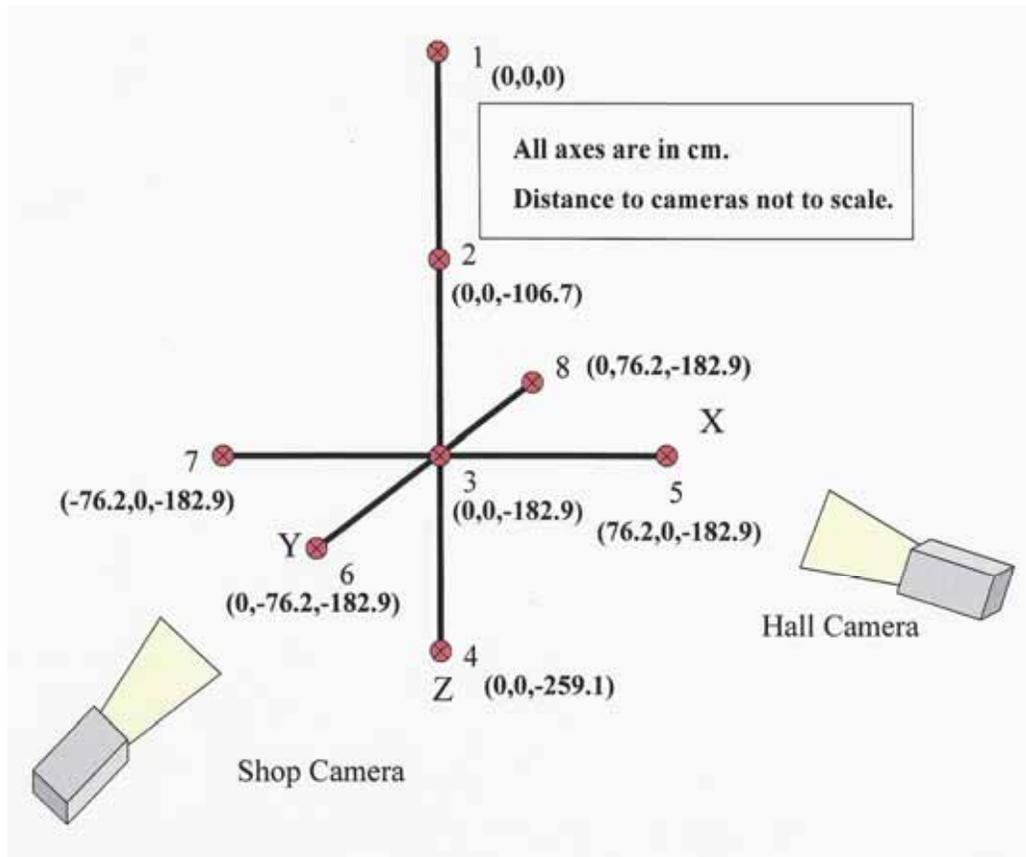

Figure 20. Diagram of Calibration Test Cross.

3. Experimental Procedure

MIDEX II was conducted by two experimenters via handheld walkie-talkies. One stayed on or near the moveable bridge with the shapes. The other was stationed with the

high-speed cameras and computer and served to coordinate the filming and retrieval of the subsurface data. For each individual drop, the experimenter below confirmed the readiness of the cameras and prepared the computer to save the appropriate film file. When this was confirmed, he signaled the one above, who turned on the high-wattage tank lighting, selected the designated shape, and held the shape against the slanted board in the “ready” position.

After a coordinated count conducted via the walkie-talkies, the experimenter at the launch position released the shape as the experimenter below began filming the drop. The shape would then fall from a position of no motion, off the slanted board and into the water surface 0.4 meters below. When the shape fell below the view of both cameras, the cameraman ceased filming, saved the appropriately named file, and again signaled the experimenter above, who would then turn off the lighting and note the time and shape in the experimental record notebook. The cycle would then repeat itself until all shapes were dropped. Recovery of the shapes was as described above.

IV. DATA RETRIEVAL AND ANALYSIS

A. DATA RETRIEVAL

Data retrieval was accomplished following all experimental test runs by converting the digital video imagery from each drop into an array of x-y-z coordinate data (Figure 21). Commercially available 3-D motion analysis software, MAXTRAQ, was the primary tool utilized to perform this function. Initially, the software was calibrated into the 3-D coordinate reference system utilizing the pairs of calibration images obtained in the initial phase of the experiment. Following calibration, both camera views were time synced and analyzed to determine the actual position of the shape in the x-y-z coordinate field. Frame-by frame analysis was performed with the software for each view by manually identifying and inputting one or two marker points associated with the test shape's position. For the Sphere and Gumdrop shapes, one marker point was used to identify the lowest position of the shape. For the Manta shape, marker point #1 was at the center of the bottom diameter, and marker point #2 was the center of the top diameter. For the Rockan shape, marker point #1 was at the center of the narrow edge at the "electronics cylinder," and marker point #2 was in the center of the thicker edge of the shape opposite marker point #1. In frames where a marker point was obscured, the position of the marker was estimated visually based on the previous and next viewable frame. Following analysis of both views, the automated functions of the software were employed to compile the 2-D images into a calibrated array of 3-D positional data. This data was saved in an electronic database for use in the final motion analysis and modeling phase of the project. Figure 22 shows a few example screenshots of the MAXTRAQ software in action.

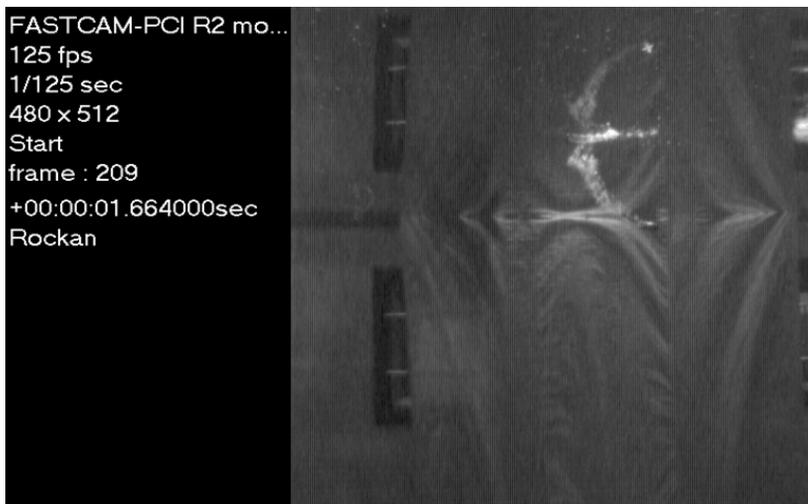

Figure 21. Examples of High Speed Film Frames.
30

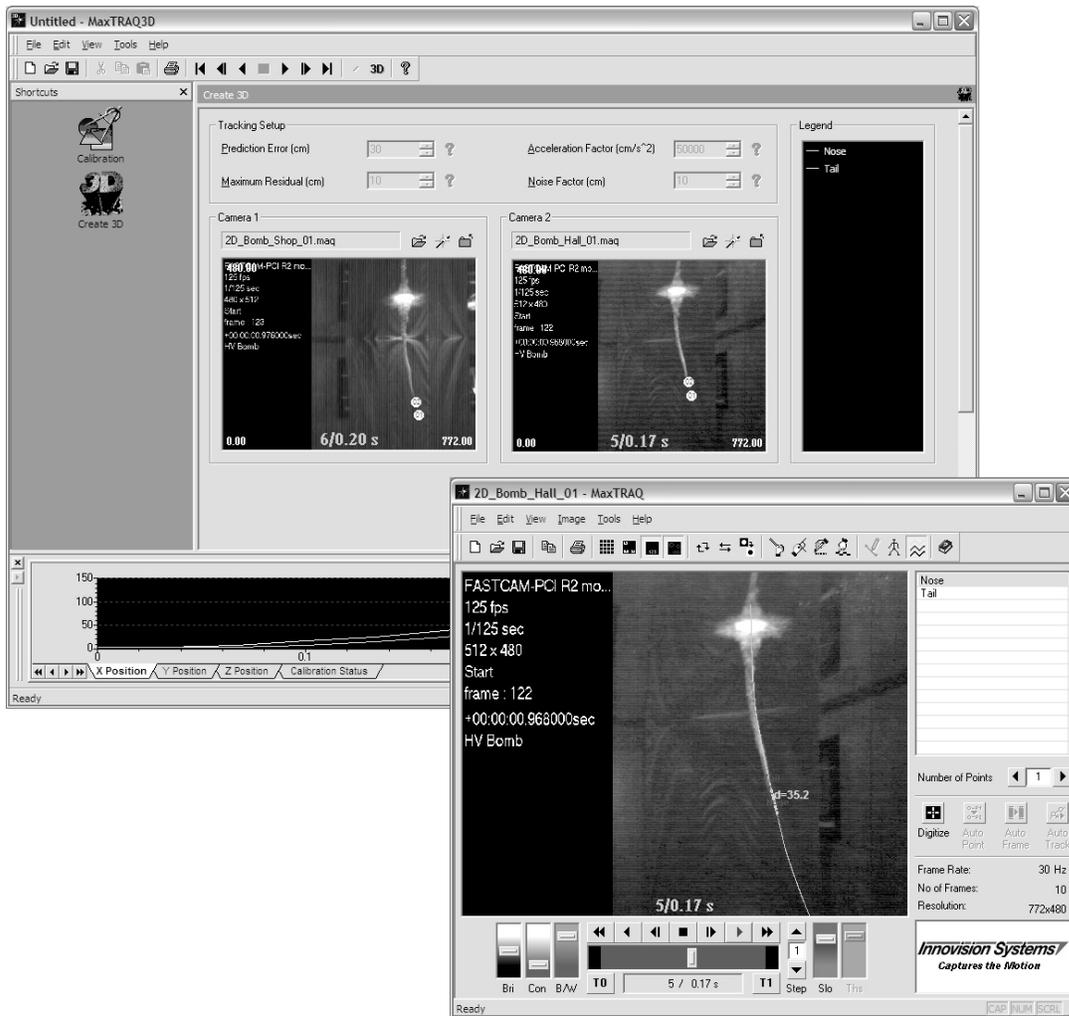

Figure 22. MAXTRAQ analysis software screenshots.

B. DATA ANALYSIS

The three-dimensional coordinate array from each test run was analyzed with specifically designed MATLAB m-files used to generate several data plots and reports. In total three plots (x-z, y-z, x-y-z) were used to depict the three dimensional trajectory of the test shape for each run. For the Rockan and Manta, the angle between the two marker points was also calculated to determine the orientation of the shape as it fell. Additionally, a summary of the final positional data point for all test runs at a depth of 2.5 m was generated.

An example of each type of plot is shown in Figures 23-25.

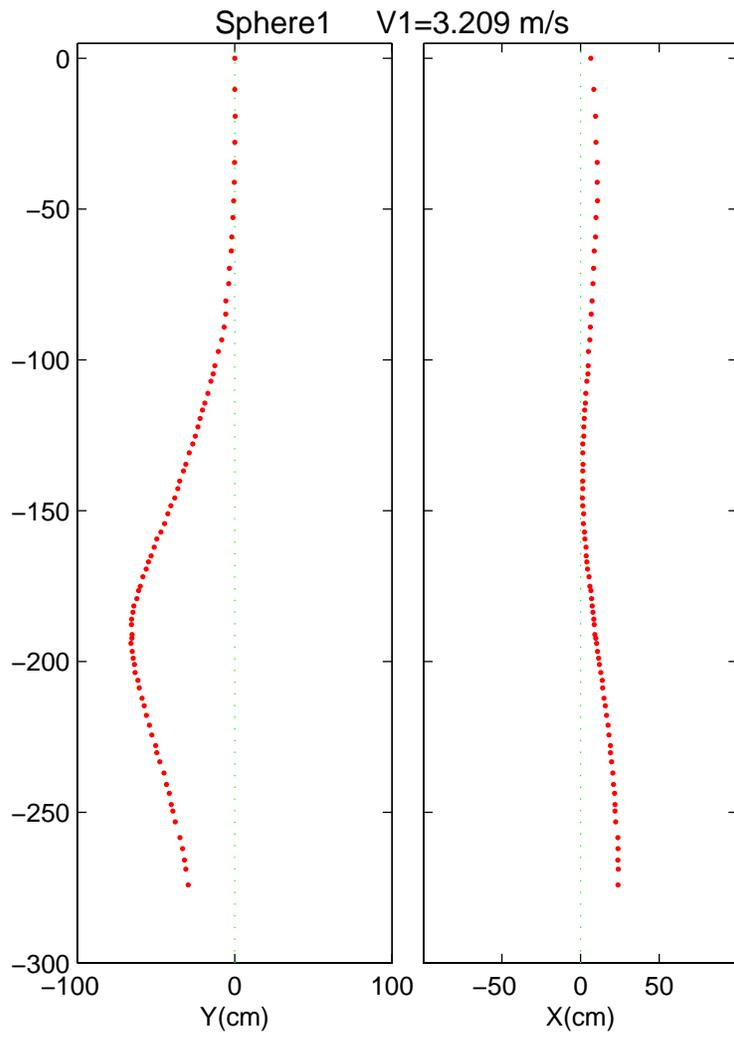

Figure 23. Sample X-Z/Y-Z Trajectory Plot.

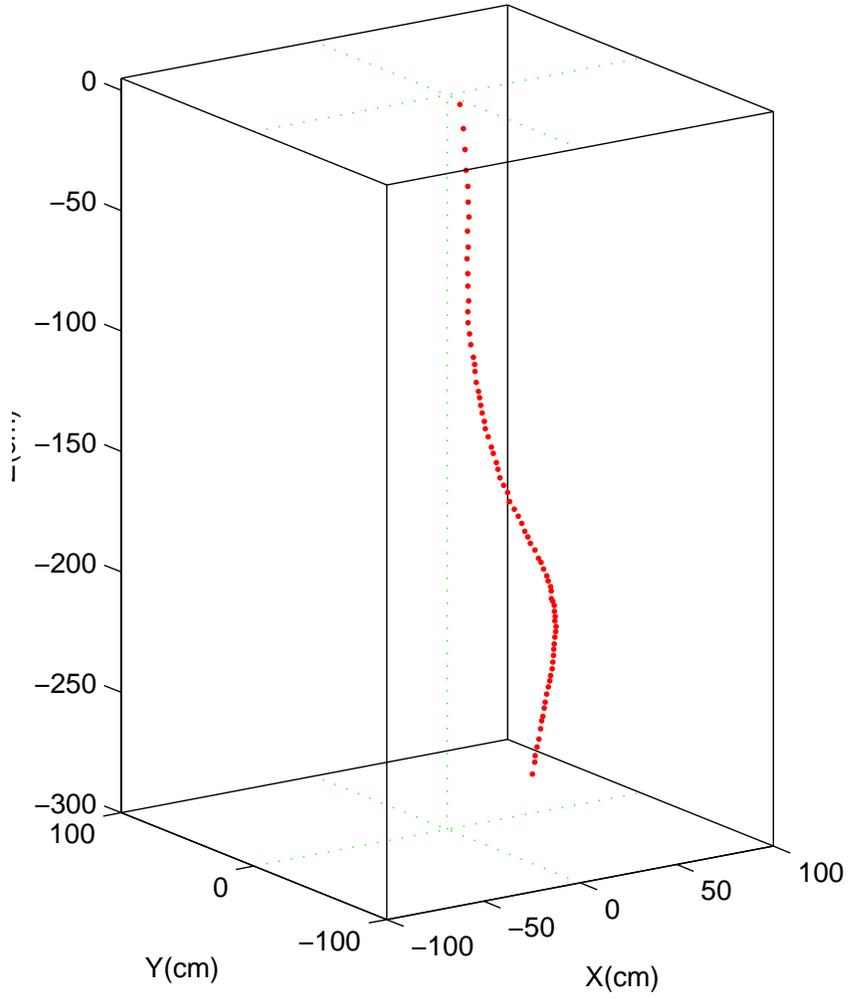

Figure 24. Sample X-Y-Z Trajectory Plot.

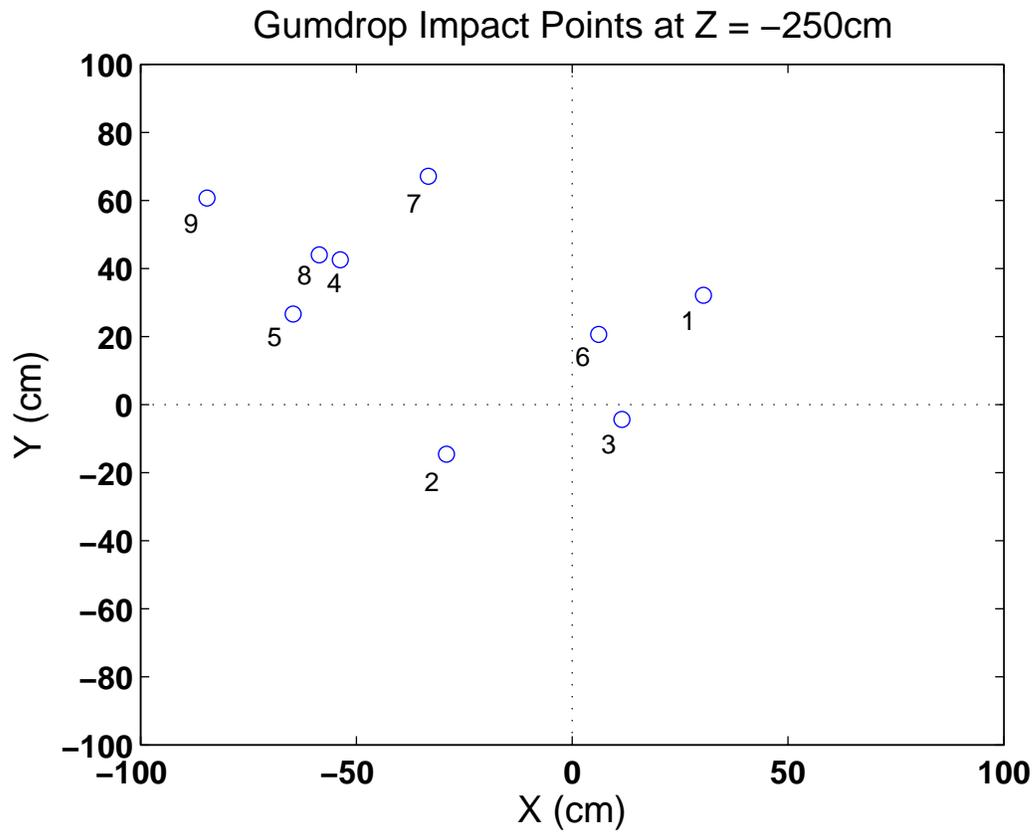

Figure 25. Final Position Data Point Sample.

V. RESULTS

A. TRAJECTORY PATTERNS

By analyzing the 2D and 3D plots of each shape drop, general trajectory patterns of each type were developed. Pattern names were based off the generalized path of each shape through the water column. The trajectory patterns are described in Tables 4-6. Examples of each are displayed in Figures 26-28. Appendix A contains all of the 2D and 3D plots.

Trajectory Pattern	Description
Straight-Arc	The shape follows a vertical path until roughly -1.0 m, then it follows a smooth arc away from the Z-axis.
Curve-Arc	The shape follows a curved path in a smooth arc away from the Z-axis.
Slant	The shape travels basically in a straight line angled off of the Z-axis/surface intersection.

Table 4. Sphere and Gumdrop Trajectory Patterns.

Manta Trajectory Pattern	Description
Flat Spiral	The shape falls with its bottom side basically parallel to the X-Y plane and following a spiraling path.
Side Twist	The shape falls with its bottom side perpendicular to the X-Y plane with the top side turning about the bottom in an alternating clockwise and anti-clockwise motion.
Erratic	The shape falls in a flipping combination of side and flat spiraling and twisting.

Table 5. Manta Trajectory Patterns.

Rockan Trajectory Pattern	Description
Flip-Dive-Flat	The shape flips once, goes into a vertical dive and settles into a slowly spinning horizontal orientation for the remainder of the drop.
Flat Spin	The shape immediately settles into a slowly spinning horizontal orientation and remains so for the whole of the drop.
Swoop-Flat Spin	The shape makes a “U” swooping motion upon entering the water, after which it settles into a slowly spinning horizontal orientation for the remainder of the drop.

Table 6. Rockan Trajectory Patterns.

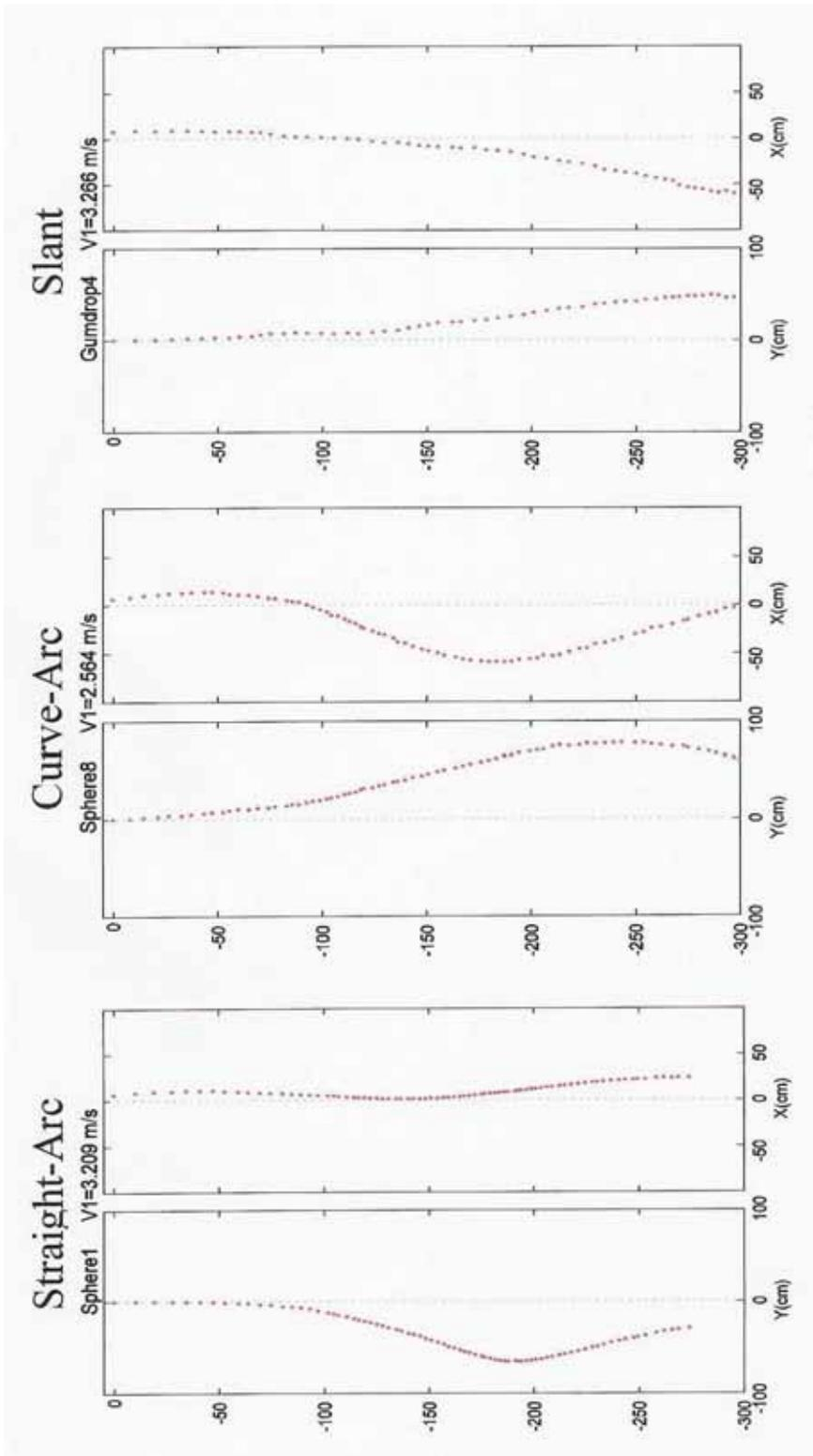

Figure 26. Sphere/Gumdrop Trajectory Examples.

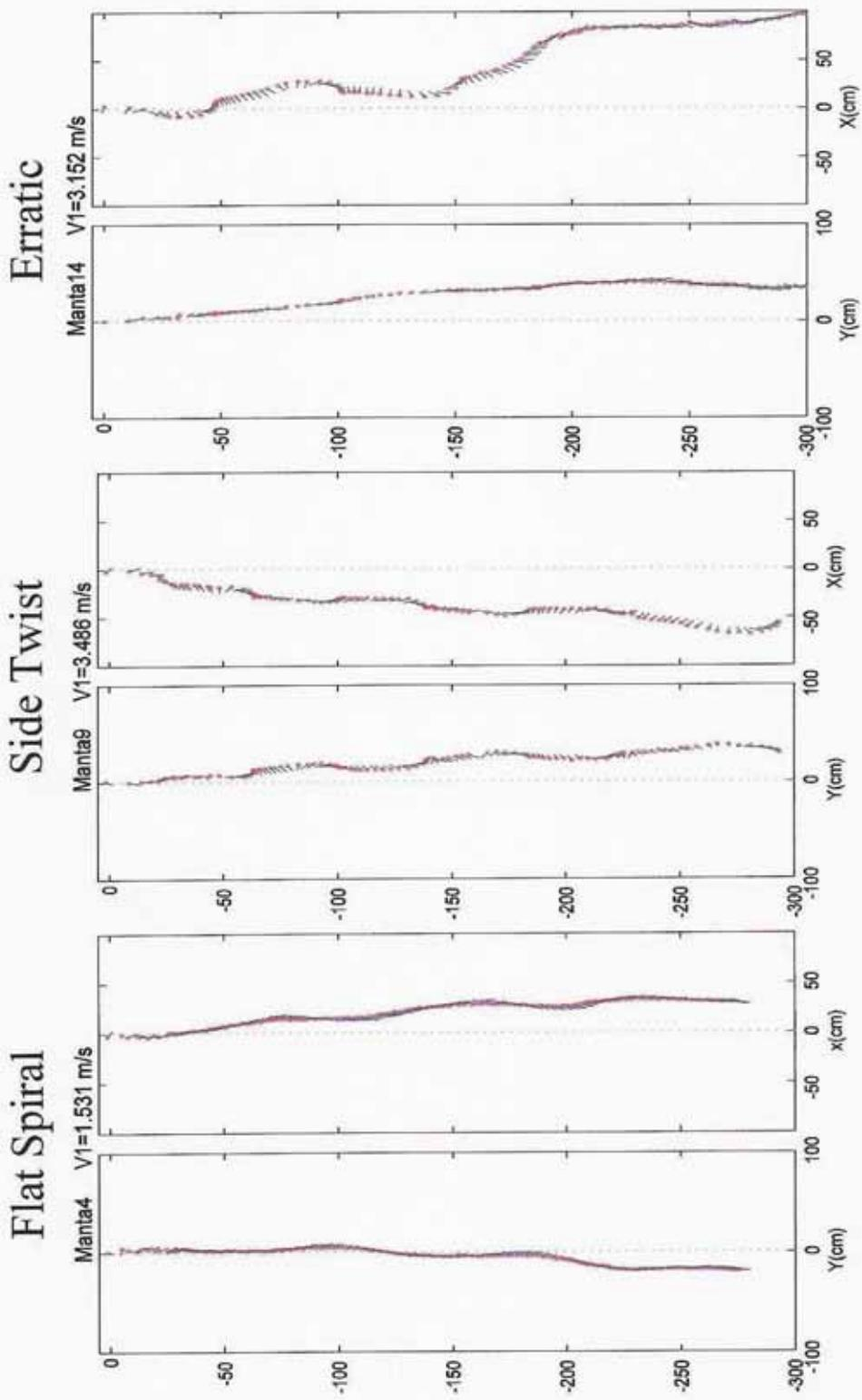

Figure 27. Manta Trajectory Examples.

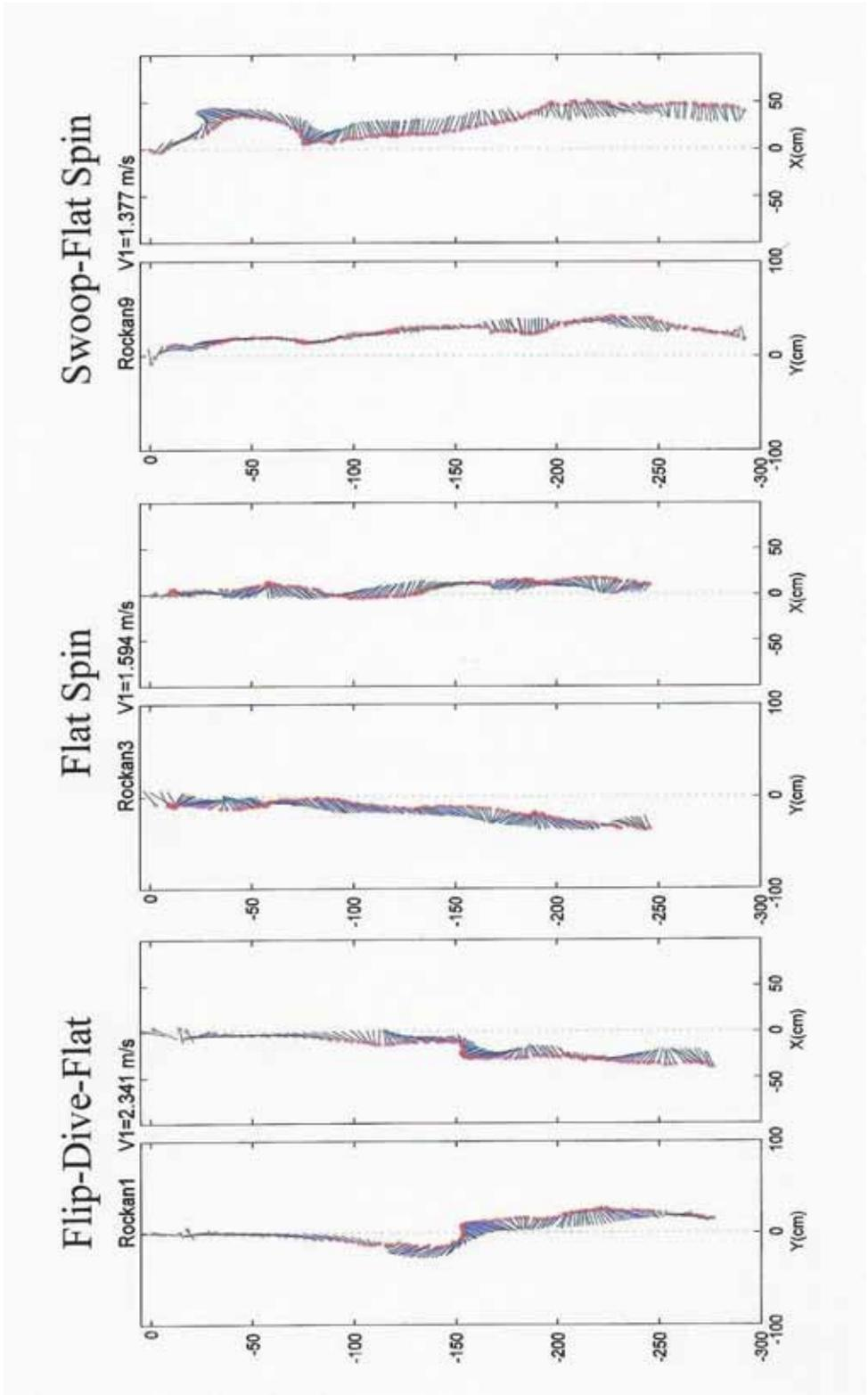

Figure 28. Rockan Trajectory Examples.

Tables 7–10 list the summarized results of all the drops. “Direction” is the general direction away from the Z-axis from which the shape moved.

Run Number	Initial Velocity (m/s) (v1)	Direction	Time(s) @ -2.50 m Z	Trajectory Pattern
1	3.209	-Y	2.272	Straight-Arc
2	3.893	+X, -Y	1.865	Straight-Arc
3	4.050	-X, +Y	1.520	Straight-Arc
4	2.785	-Y	2.096	Straight-Arc
5	3.191	+X	2.008	Straight-Arc
6	3.337	+X, +Y	1.456	Straight-Arc
7	2.965	+X, -Y	1.648	Straight-Arc
8	2.564	-X, +Y	1.984	Curve-Arc
9	3.290	+X, +Y	1.525	Curve-Arc
10	2.898	+X	1.680	Straight-Arc
11	2.789	-X, -Y	1.792	Curve-Arc
12	2.800	-X, +Y	1.696	Curve-Arc
13	3.001	+/-X, +Y	1.808	Curve-Arc
Average v1 – 3.136		Average Time – 1.796		

Table 7. Sphere Results.

Run Number	Initial Velocity (v1)	Direction	Time(s)@ -2.50 m Z	Trajectory Pattern
1	3.730	+X, +Y	1.296	Curve-Arc
2	4.314	-Y	1.792	Straight-Arc
3	3.979	+X	1.576	Straight-Arc
4	3.266	-X, +Y	1.344	Slant
5	3.871	-X, +Y	1.464	Slant
6	2.603	-Y	1.504	Curve-Arc
7	2.563	-X, +Y	1.472	Curve-Arc
8	2.370	-X, +Y	1.308	Curve-Arc
9	2.206	-X, +Y	1.400	Curve-Arc
Average v1 – 3.211		Average Time – 1.462		

Table 8. Gumdrop Results.

Run Number	Initial Velocity (v1)	Direction	Time(s) @ -2.50 m Z	Trajectory Pattern
1	1.819	+X	3.360	Side Twist
2	1.573	+X	3.956	Flat Spiral
3	2.160	+X	3.248	Side Twist
4	1.531	+X, -Y	4.800	Flat Spiral
5	3.116	+/-X, -Y	4.040	Flat Spiral
6	1.653	-	4.544	Flat Spiral
7	1.881	-Y	5.040	Flat Spiral
8	1.670	+X	4.656	Flat Spiral
9	3.486	-X, +Y	3.120	Side Twist
10	2.265	-X, +Y	2.940	Side Twist
11	2.398	+X, +Y	3.216	Erratic
12	2.114	-X, +Y	2.816	Side Twist
13	3.143	+Y	2.928	Side Twist
14	3.152	+X, +Y	3.176	Erratic
15	3.199	-X, +Y	3.712	Erratic
Average v1 – 2.344		Average Time– 3.703		

Table 9. Manta Results.

Run Number	Initial Velocity (v1)	Direction	Time(s)@ -2.50 m Z	Trajectory Pattern
1	2.341	-X	4.048	Flip-Dive-Flat
2	2.805	+X, -Y	3.984	Flip-Dive-Flat
3	1.594	-Y	5.472	Flat Spin
4	1.066	+X, -Y	5.824	Swoop-Flat Spin
5	1.796	+X, -Y	6.176	Swoop-Flat Spin
6	2.213	+Y	4.848	Flat Spin
7	2.597	-X, -Y	4.912	Flip-Dive-Flat
8	2.652	-Y	4.880	Flip-Dive-Flat
9	1.377	+X, +Y	4.672	Swoop-Flat Spin
10	2.378	+X, +Y	4.138	Swoop-Flat Spin
11	2.018	+X, +Y	4.868	Swoop-Flat Spin
12	2.289	+X, +Y	3.156	Flip-Dive-Flat
13	1.872	+X, +Y	4.740	Swoop-Flat Spin
14	2.362	+Y	3.912	Swoop-Flat Spin
Average v1 – 2.097		Average Time– 4.688		

Table 10. Rockan Results.

B. FINAL POSITION PLOT

Because the bottom of the test tank was below the camera views, a Z-level of -2.50 m was selected as “bottom depth” for purposes of a final position plot (Figure 29). When scaled, the -2.50 m Z-level equates to a 15 m (41 ft) depth. Individual shape plots are located in Appendix B.

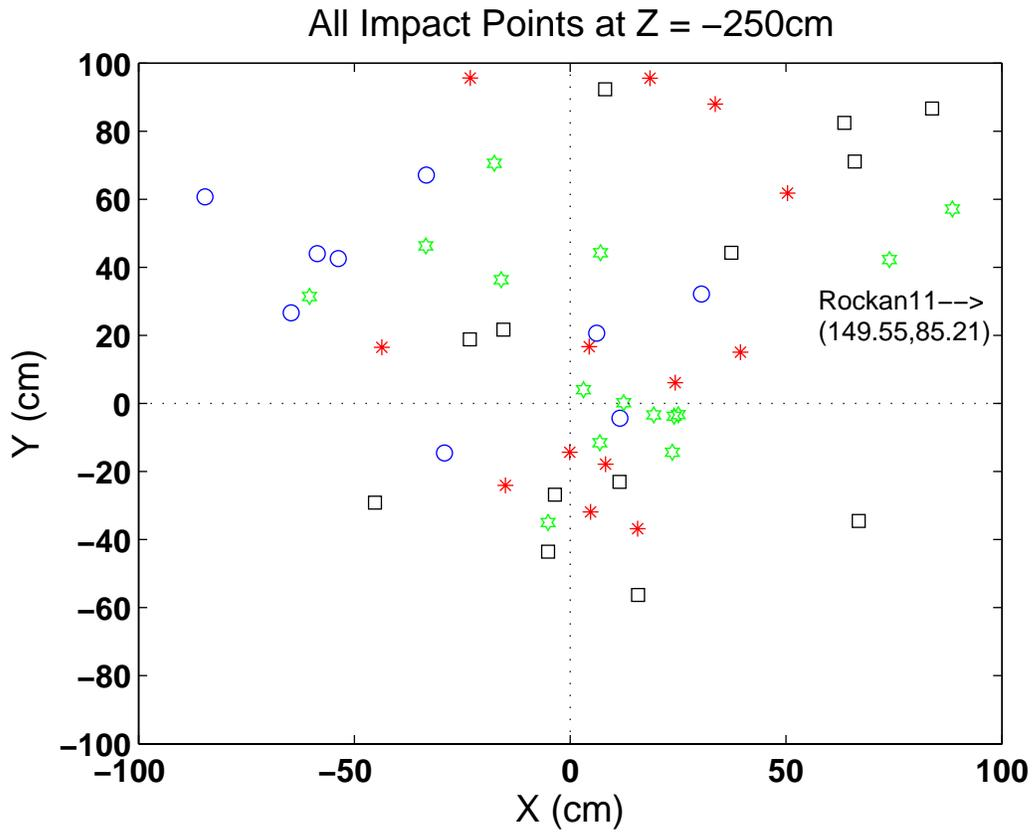

Figure 29. Final Position Plot (All Shapes). Sphere Drop Points are indicated by Red Stars. Gumdrop Drop Points are indicated by Blue Circles. Manta Drop Points are indicated by Green Hexagons. Rockan Drop Points are indicated by Black Squares.

VI. DISCUSSION

A. SHAPE TRAJECTORIES

It is not surprising that each type of shape seemed to exhibit its own kind of motion. The Sphere and Gumdrop shapes seemed to exhibit generally simple trajectory patterns based on gravity and the shape's rotation about its own axis. Both of those shapes were relatively hydrodynamically smooth, resulting in the quickest drop times in the experiment. The Gumdrop shape had the fastest average time to -2.50 m Z with 1.462 seconds. The Sphere seemed to favor a Straight-Arc trajectory (0.62 probability) over a Curve-Arc one (0.38 probability). The Gumdrop seemed to favor a Curve-Arc (0.56 probability) over both the Straight-Arc (0.22 probability) or simple Slant (0.22 probability).

The Manta shape's bottom-weighted truncated cone was a more complex, less hydrodynamic shape. Hence, it tended to either fall with a Side Twist (0.40 probability) or with Flat Spiral (0.40 probability). The remaining runs were Erratic (0.20 probability). The average time, 3.703 seconds, was also over twice that of either the Sphere or Gumdrop shapes.

The Rockan shape was the most complex. Though it was designed to mimic the actual Rockan's ability to smoothly glide through the water, the shape failed to do so in any drop. Instead, it tended to either fall in a Swoop-Flat Spin (0.50 probability) or in a Flip-Dive-Flat (0.36 probability) trajectory. Both of those trajectory types show the potential for Rockan gliding. On two drops (0.14 probability), the shape went directly into a Flat Spin. Because the shape becomes much less hydrodynamic in the vertical when it is at a horizontal angle, the average time to -2.50 m Z (4.688 seconds) was even greater than the Manta shape. Table 11 summarizes the probabilities for all shapes.

<u>Shape Type</u>	<u>Trajectory Type</u>	<u>Probability</u>
Sphere	Straight-Arc	0.62
(13 total drops)	Curve-Arc	0.38
	Slant	0.00
Gumdrop	Straight-Arc	0.22
(9 total drops)	Curve-Arc	0.56
	Slant	0.22
Manta	Flat Spiral	0.40
(15 total drops)	Side Twist	0.40
	Erratic	0.20
Rockan	Flip-Dive-Flat	0.36
(14 total drops)	Flat Spin	0.14
	Swoop-Flat Spin	0.50

Table 11. Trajectory Probabilities for All Shapes.

B. IMPACT POINT TENDENCIES

The shape's water phase trajectory is a major factor of the mine shape's ultimate impact location. The dispersion of impact points is wide and varied. 9 of 13 Sphere drops (0.69 probability), 4 of 9 Gumdrop drops (0.44 probability), 11 of 15 Manta drops (0.73 probability), and 8 of 14 Rockan drops (0.57 probability) fell within 0.50 m of the Z-axis. Despite the relative simplicity of the Sphere and Gumdrop shape, as well as their shape symmetry, this did not seem to correlate well with how close the shape ended up to the Z-axis. Surprisingly, the dispersion patterns for both the Sphere and Gumdrop are almost as wide as the more complex Manta and Rockan shapes. Potential unequal weight distribution, discussed later, or rotation about the shape's own axis may have caused such deviation from a straight fall down.

There also seems to be an apparent bias for the shapes' final positions to be in the +Y quadrants. While some of this bias may be the result of camera distortion, this was probably caused by residual +Y horizontal initial velocity as the shape entered the water column from its launch position on the ramp.

C. SCALING CONCERNS

Scaling shapes down from actual mines does introduce the potential for altered trajectory based on changing the drag coefficient. For true scaling, the Reynolds number should be identical for the full scale (FS) and the 1/6 scale model. It can be then inferred that the kinematic viscosity should be reduced by the scale factor. Since the mine would be falling in the same liquid medium (water), kinematic viscosity remains the same. Thus the speed of the falling mine determines how much drag the mine experiences to affect its trajectory. In MIDEEX II, the shapes' falling speeds fell primarily in the laminar flow region (Figure 30). In that region, the drag coefficient can change with different Reynolds numbers, but the speeds were of sufficient magnitude that the drag coefficient remained in the 0.5-0.6 range, reducing the drag coefficient error. A small amount of the speeds were in the turbulent flow region, where the drag coefficient changes very little for different Reynolds numbers, minimizing the drag coefficient error there as well. So the scale models should provide a good representation of the full-scale mine (Gefken, 2005).

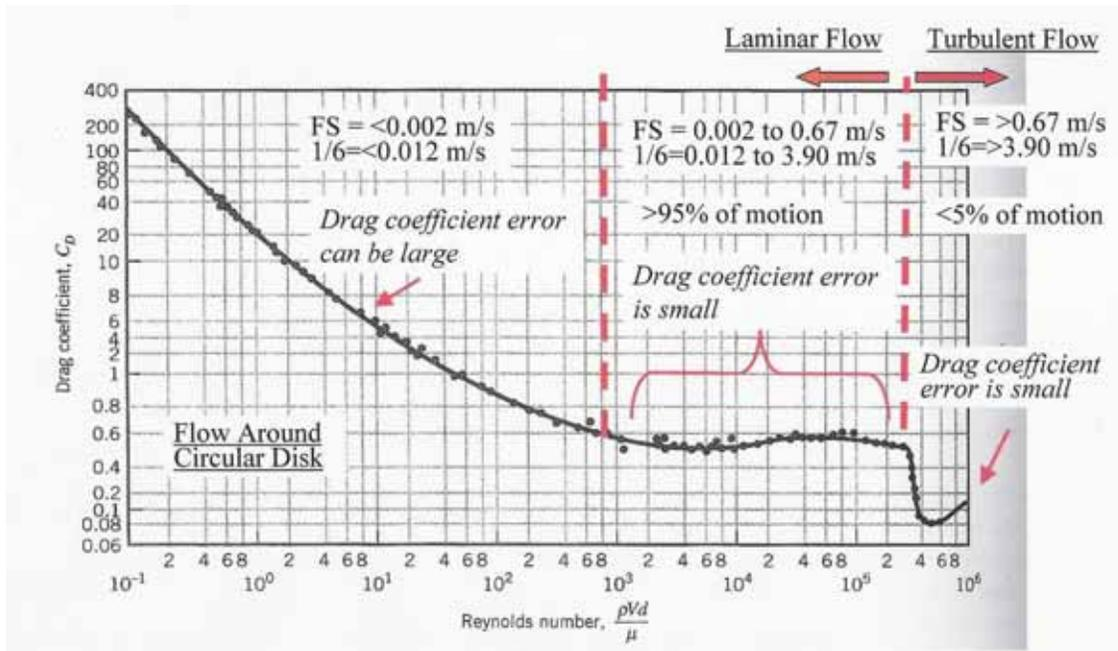

Figure 30. Drag Coefficient vs. Reynolds Number for Flow Around a Circular Disk (After Gefken, 2005).

The Rockan scale model did have a specific trajectory issue independent of its Reynolds number, however. Scaling the Rockan shape to 1/6 the actual size of the operational mine reduced its ability to “glide” through the water as easily as the true Rockan, affecting the “realism” of the Rockan shape trajectory.

D. SOURCES OF ERROR

In MIDEX II, there were errors that hindered determination of the mine shape’s exact position and accurate trajectory within the water column. Filming in an underwater environment introduces an inherent degree of parallax distortion above and below the cameras’ focal points. This distortion was minimized, however, by first placing the cameras back at the tank wall windows and by using the calibration cross method described previously.

The use of high-speed cameras also introduced shape position tracking difficulty. A higher frame rate per minute necessitated much brighter lighting in the test tank than

was available during the experiment. While the water appeared bright and clear on low-speed film, even with the remnants of blue dye in the test tank, the water was much dimmer on the 125 Hz film. This darkened result made distinguishing the black mine shape from the background more difficult. The darkness problem could not be counteracted with zooming in at the shape's location. Hence, some frames of each fall, especially when a shape was nearer to the bottom of the tank, are almost unreadable.

A shape entering the water also generates an air cavity. Not only can that air pocket greatly affect the initial motion, it also collapses into a stream of obscuring bubbles. The air cavity effect on the motion was minimized by the low mine shape initial velocities. However, the bubbles from the cavity prohibited automatic tracking via software. In some frames, the mine shape was completely obscured and had to be estimated based on the position of the shape in the surrounding frames.

It should be noted again that all the mine shapes were solid masses made of a resin/bronze powder mixture. As such, the shapes based on the Manta and Rockan mines approximated the shape, average density and COM of the real-world mines. However the shapes did not realistically detail the inner structure, electronics, or explosive distribution of their counterparts. Furthermore, the denser brass powder within the mixture may have "settled" somewhat in the molding process. Settling was minimized by regularly rotating the molds during the hardening process, but the inevitable amount of settling occurring probably resulted in slightly unsymmetrical weight distribution that affected the trajectory results.

THIS PAGE INTENTIONALLY LEFT BLANK

VII. CONCLUSIONS

MIDEX II is another step in the ongoing process to understand and predict the various parameters that affect a mine's water-phase trajectory. In this case, the primary parameter tested was the mine's shape. Observed trajectories were highly variable, but several broad conclusions can be reached.

The Sphere and Gumdrop shapes exhibited smooth, arcing drop paths, with the Sphere tending to favor a Straight-Arc trajectory and the Gumdrop favoring a Curve-Arc trajectory. The denser Gumdrop shape did have a faster average drop time to the 2.50 m depth. Several Gumdrop drops exhibited virtually no arc.

The Manta shape tended to fall either in a Flat Spiral trajectory, where its bottom surface stayed generally parallel to the tank bottom, or a Side Twist trajectory, where its bottom surface stayed relatively perpendicular to the tank bottom. Several drops were highly erratic. The Manta's average time to 2.50 m was also markedly higher than either the Sphere or Gumdrop.

The Rockan shape tended to either "flip" or "swoop" as it entered the water, but in every case, it eventually settled into a Flat Spin-type trajectory for the remainder of the drop. The scaled shape did not demonstrate substantial "gliding" behavior like its real-world counterpart. The Rockan also exhibited the highest average times to the 2.50 m depth. Due to previously discussed factors, the dispersion of all four shapes (even the symmetrical Sphere and Gumdrop) on the X-Y plane at -2.50m Z was wide and variable.

Further research and experimentation on mine hydrodynamics is needed. More realistic modeling of the Manta and Rockan mines, to include inner mechanics, electronics, and explosive distribution, should be attempted. Furthermore, scaling the models to a closer size to the actual mines may provide more accurate trajectory patterns, especially in the case of the Rockan. The cost and logistical support of the experiment would increase, but the more realistic results would offset this. The sources of error from MIDEX II would also be minimized. Lesser or greater gyrations of the shapes may occur with larger versions as well.

Changing the conditions of the water column is also an option for further work. Such changes could include but are not limited to generating various currents at different water depths (or conversely, dropping the shapes from a moving platform) or implementing turbulent mixing to simulate coastal processes during the drops.

In any case, the trajectory information gathered in MIDEX II needs to be compared with the results of IMPACT 35 using the same initial conditions for model refinement and validation. Chaotic features of MIDEX II trajectories should be investigated with instability and predictability analyses. Differences and similarities with IMPACT 35 can then be used to generate “equivalent” cylindrical equations to approximate trajectories of non-cylindrical mines in the next iteration of the IBPM.

APPENDIX A. MINE TRAJECTORIES

Appendix A contains all the 2-D X vs. Z, Y vs. Z, and 3-D X-Y-Z plots that were used to establish generalized trajectory patterns. The axes are in centimeters.

Sphere Drop 1

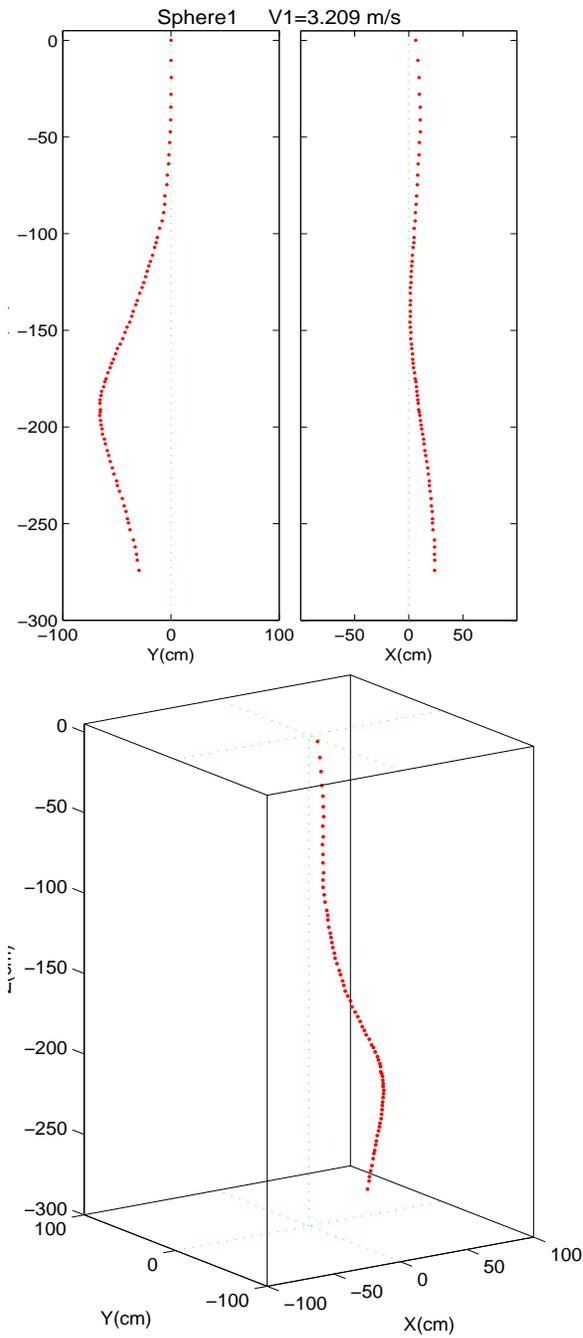

Sphere Drop 2

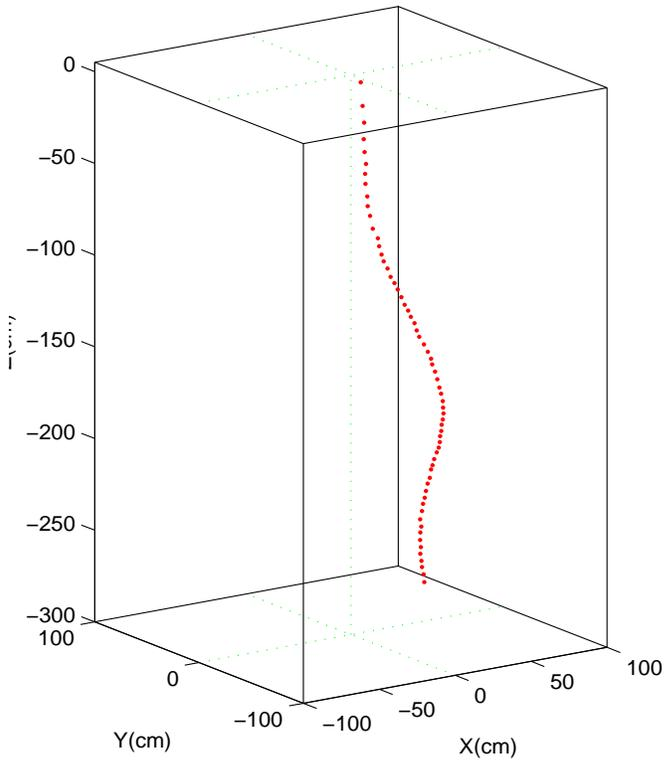
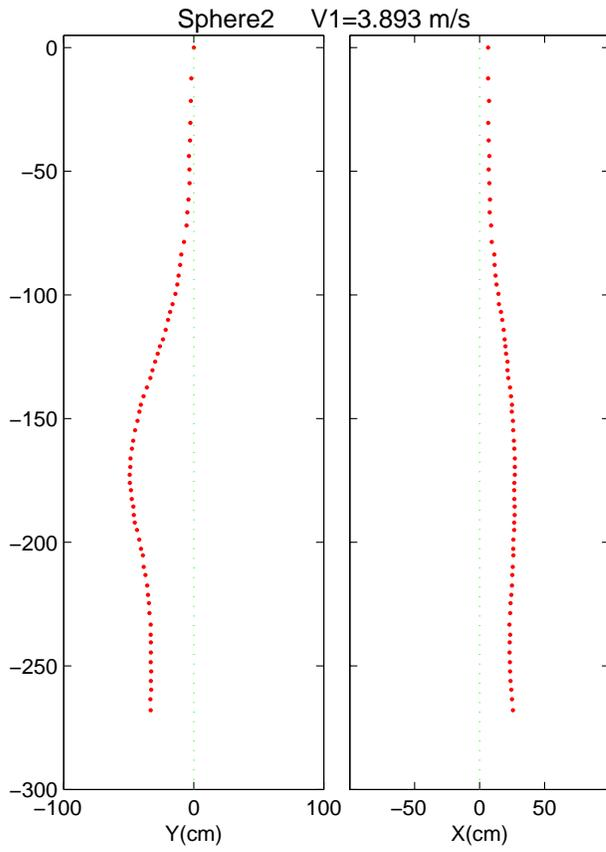

Sphere Drop 3

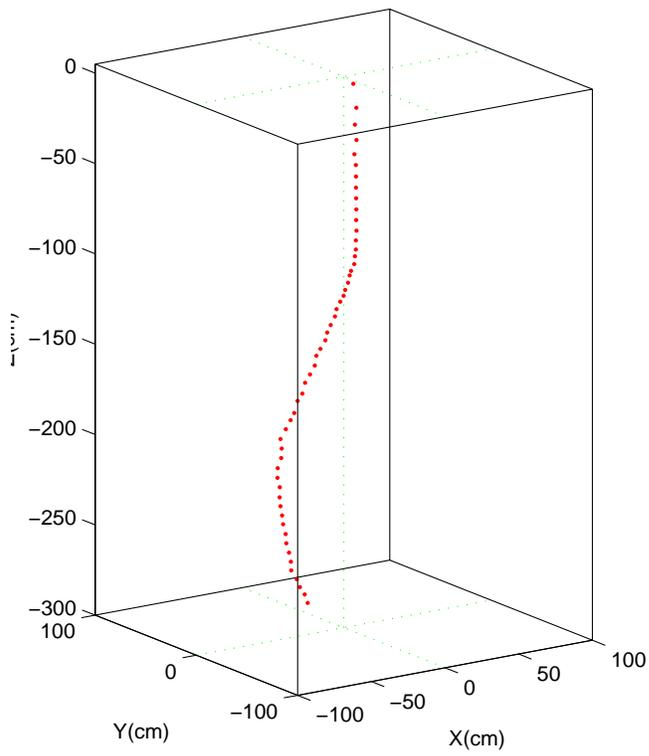
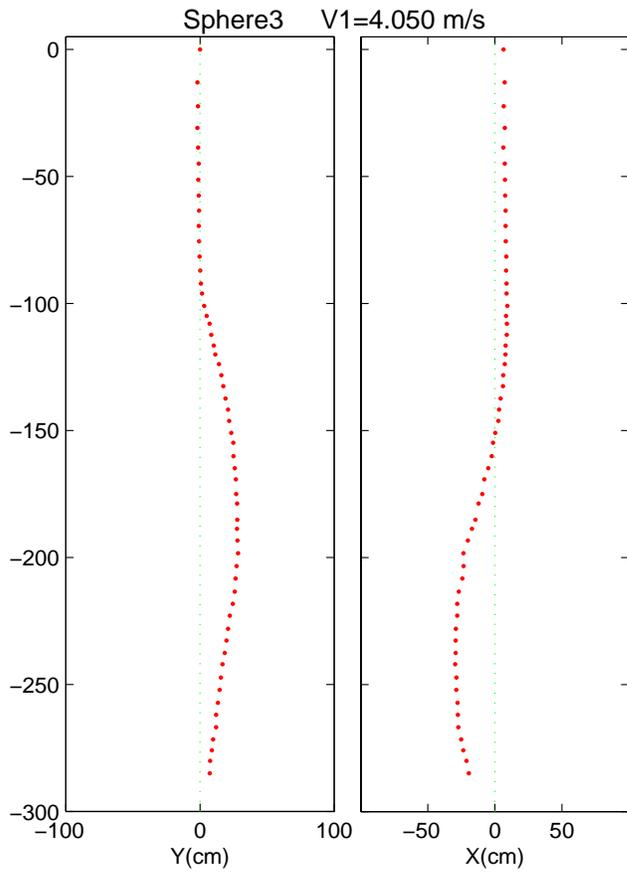

Sphere Drop 4

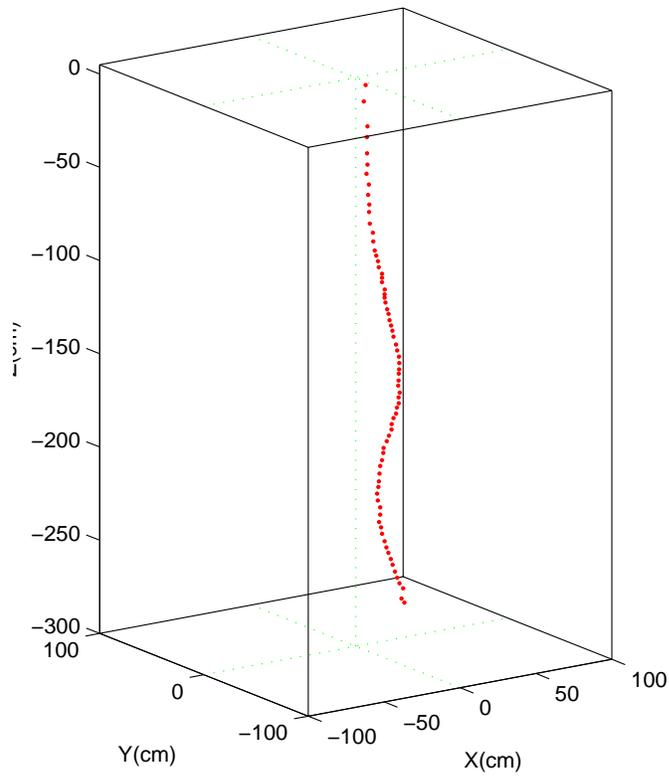
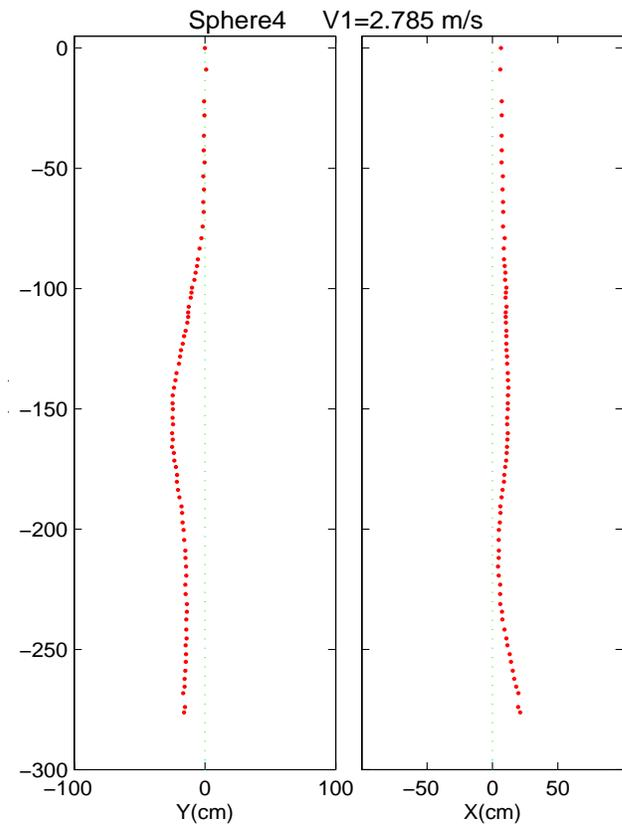

Sphere Drop 5

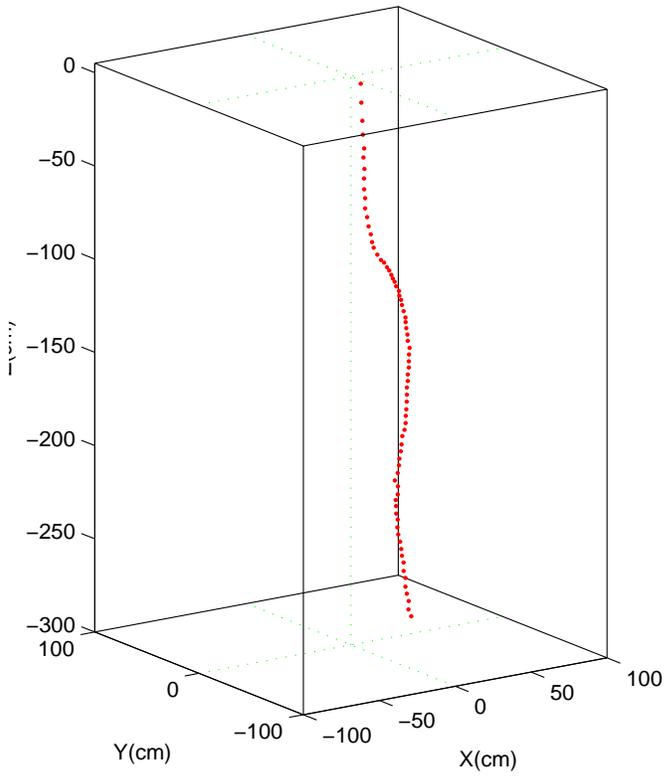
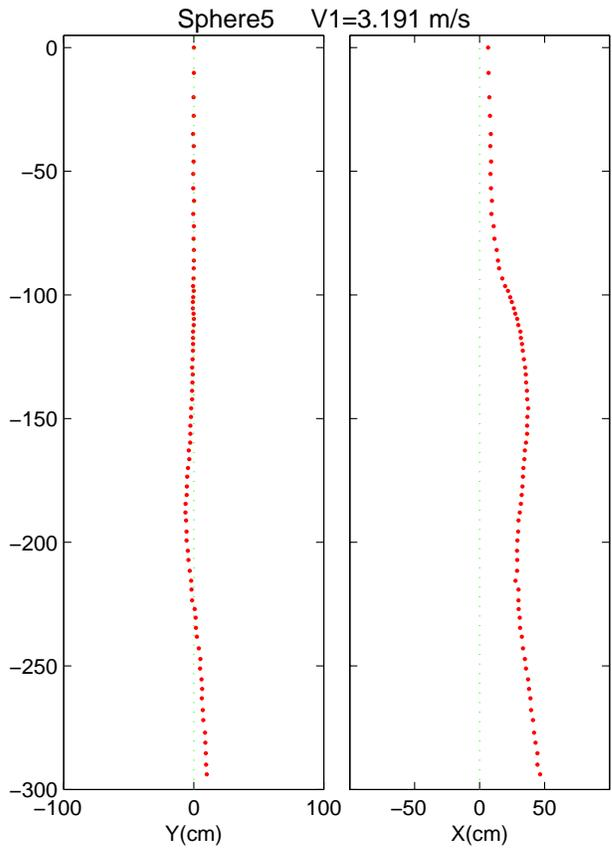

Sphere Drop 6

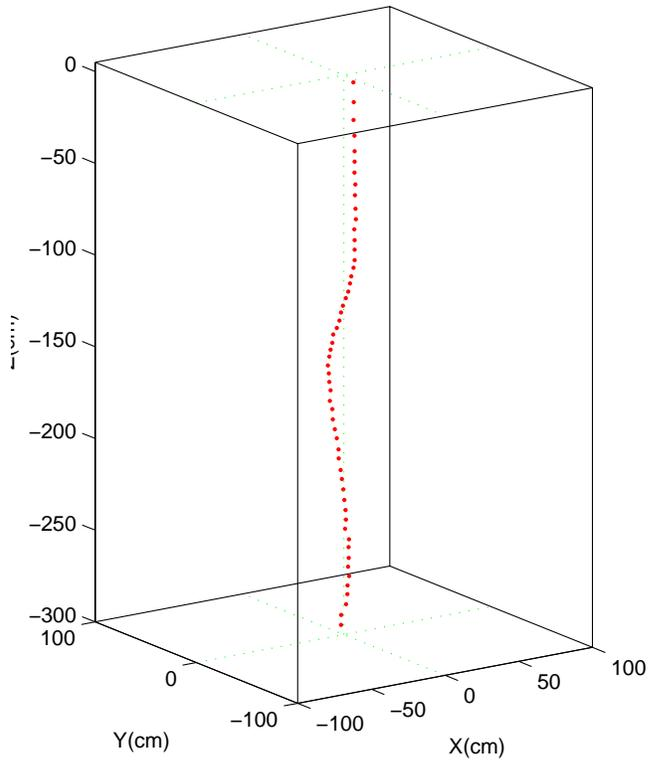
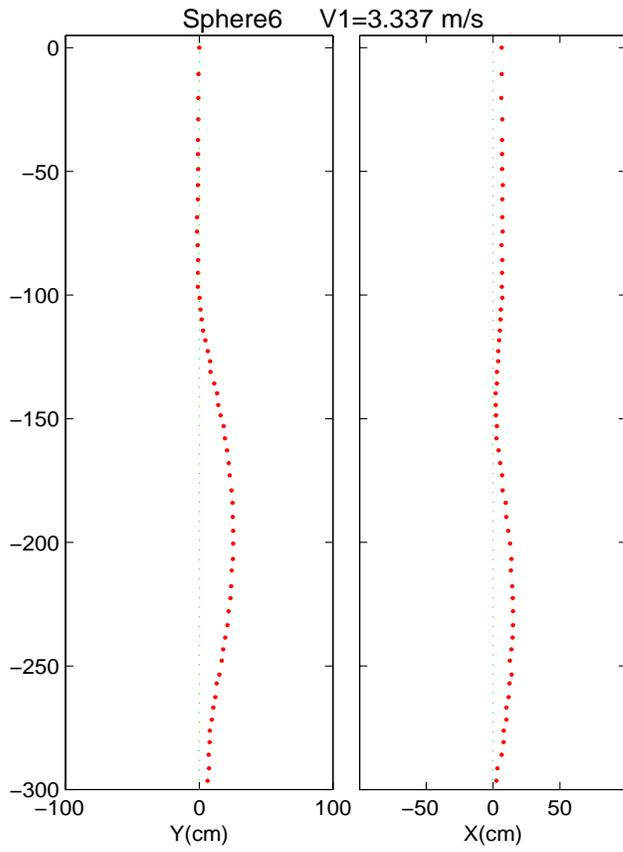

Sphere Drop 7

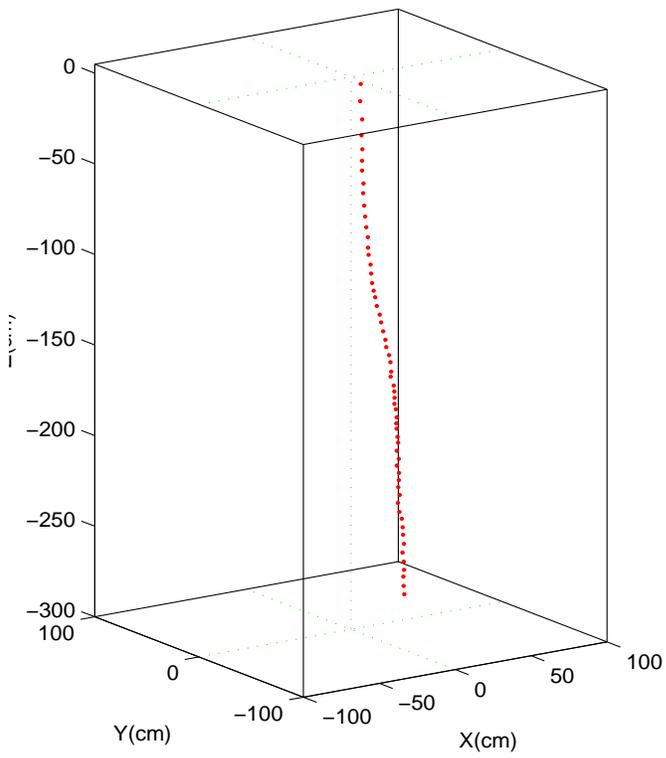
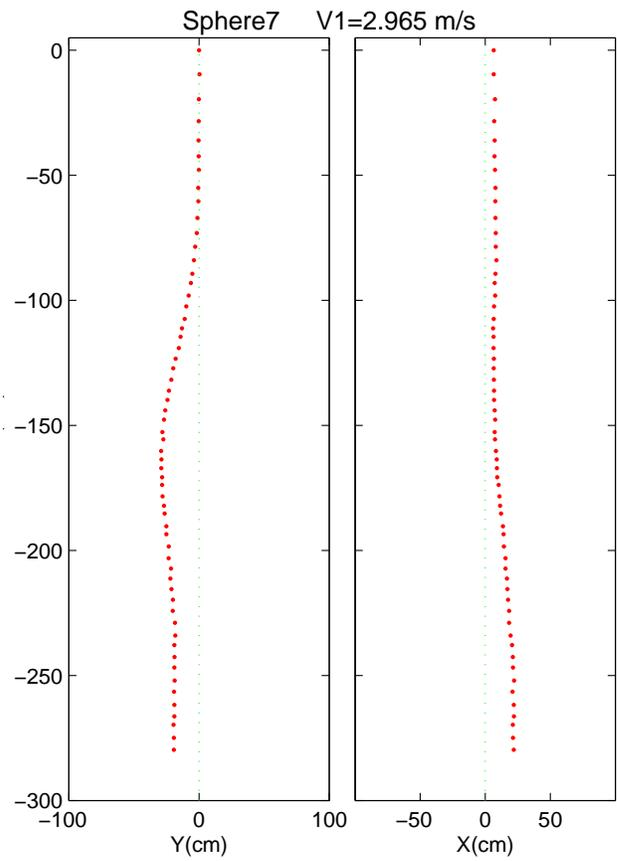

Sphere Drop 8

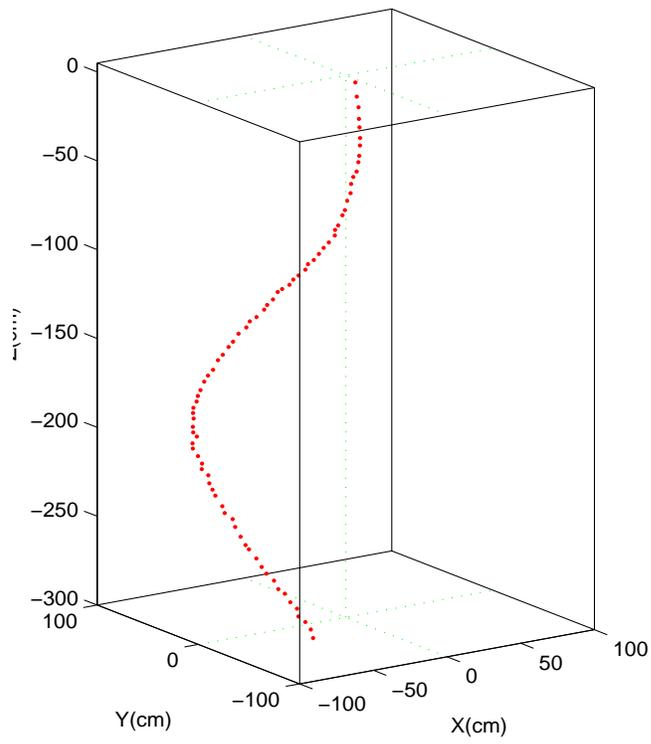
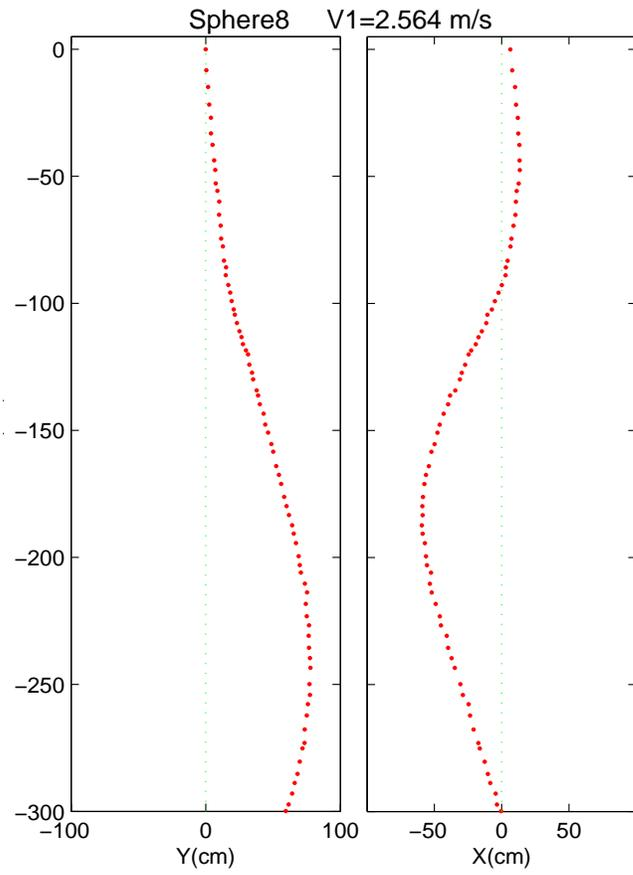

Sphere Drop 9

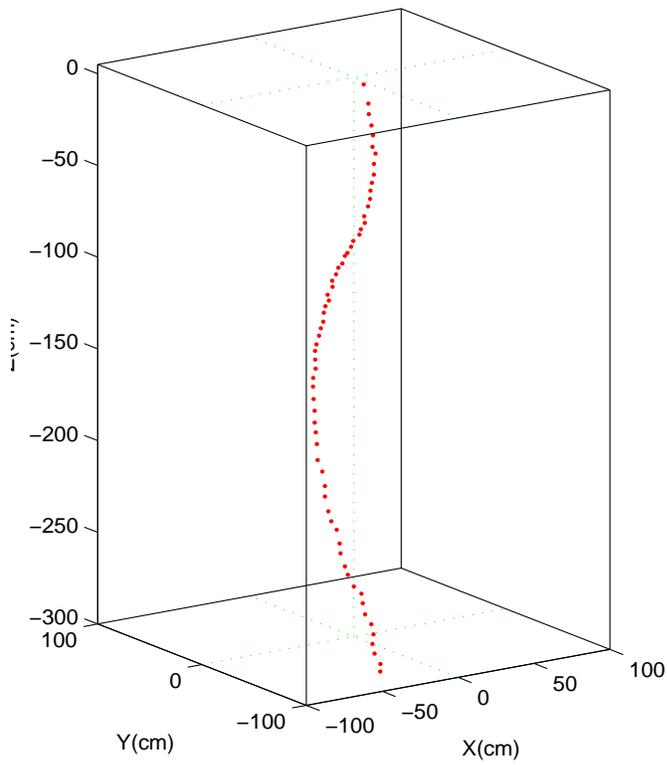
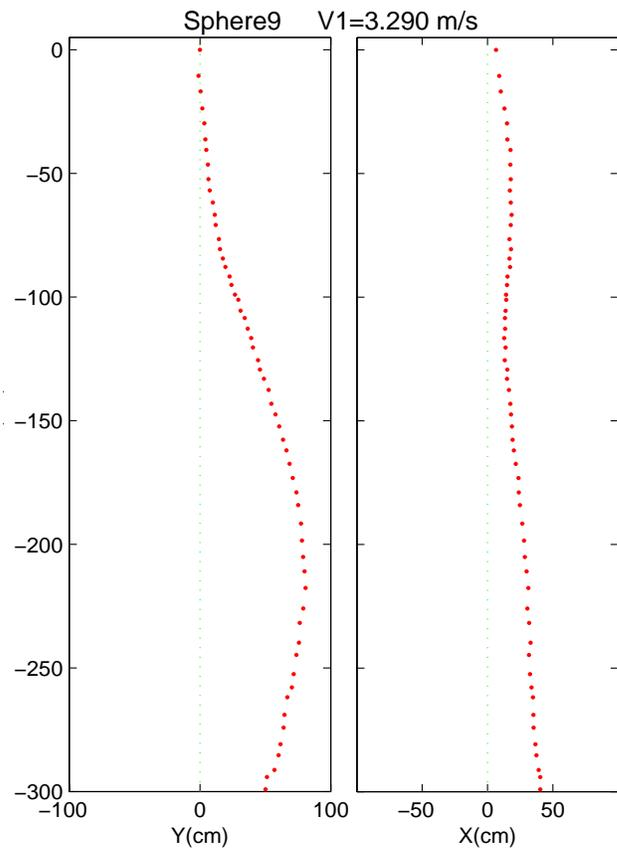

Sphere Drop 10

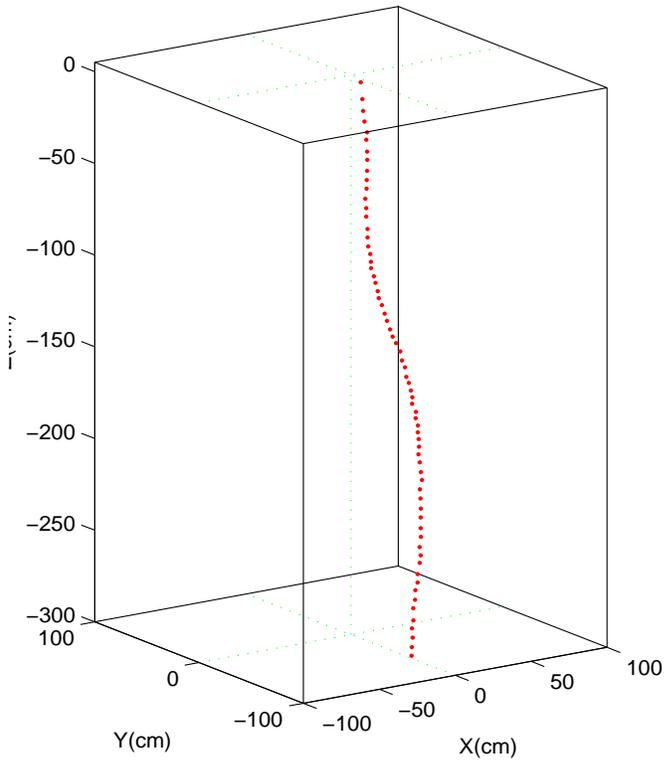
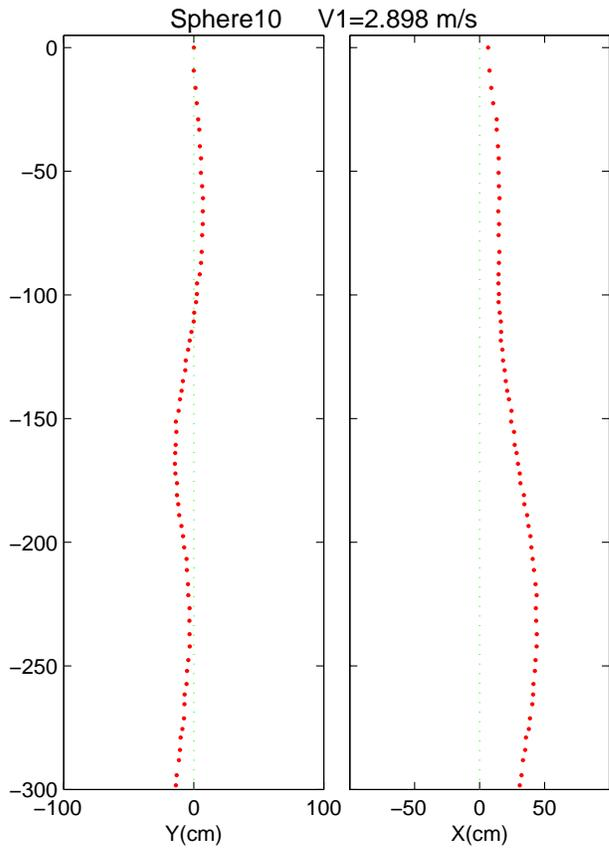

Sphere Drop 11

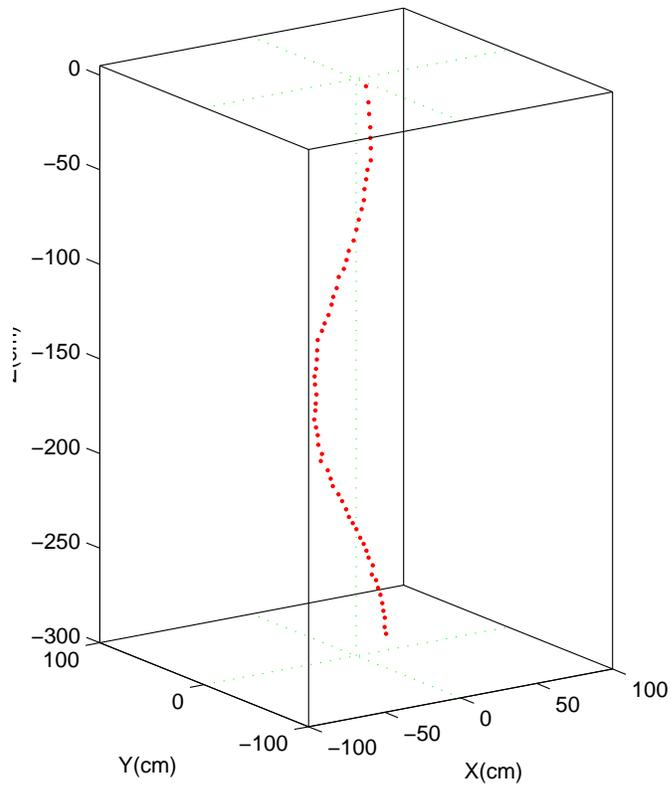
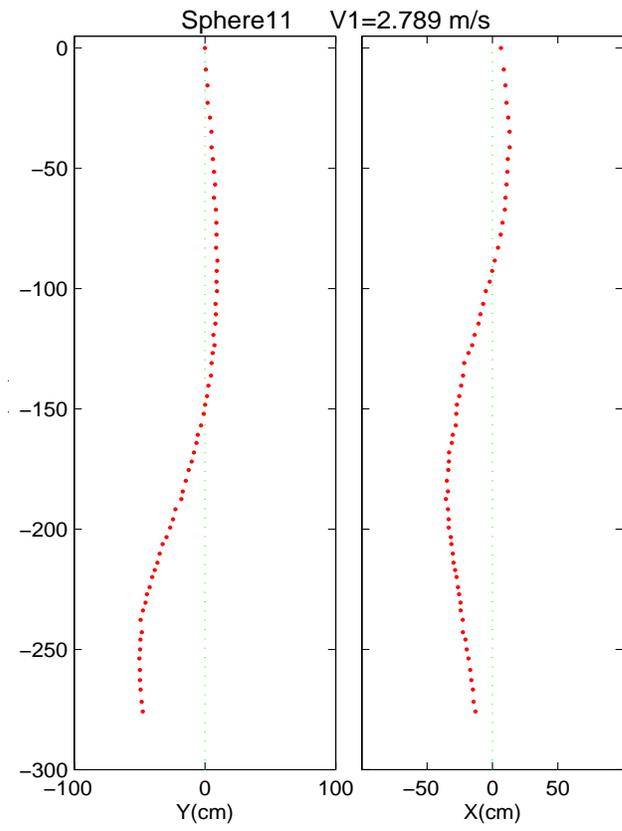

Sphere Drop 12

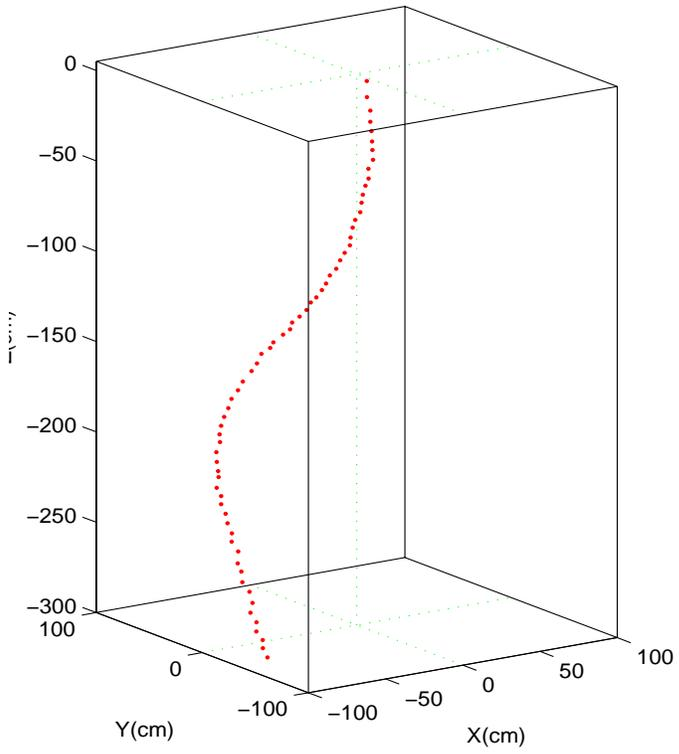
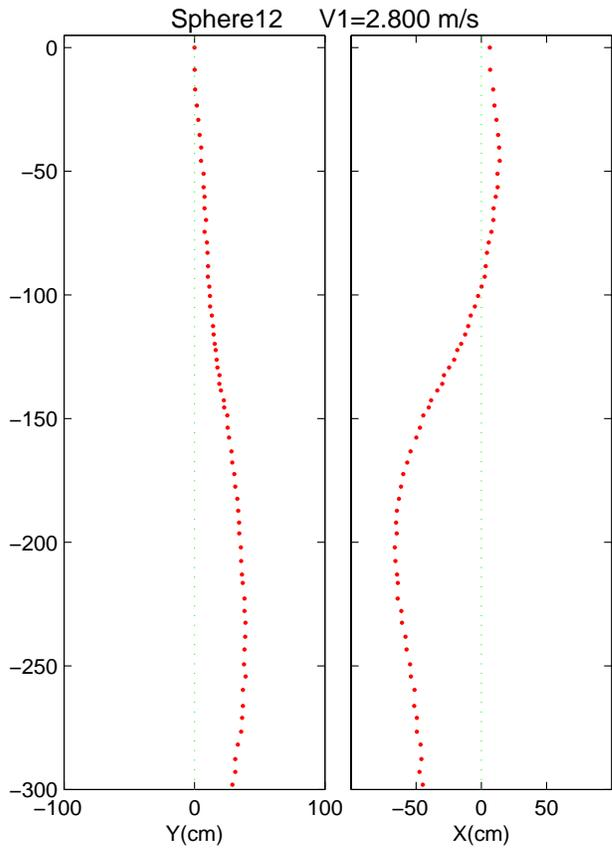

Sphere Drop 13

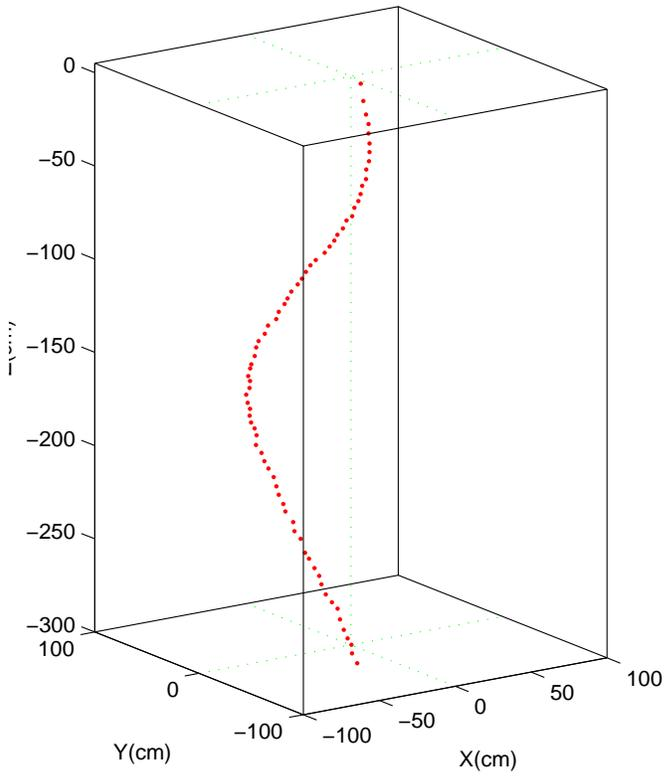
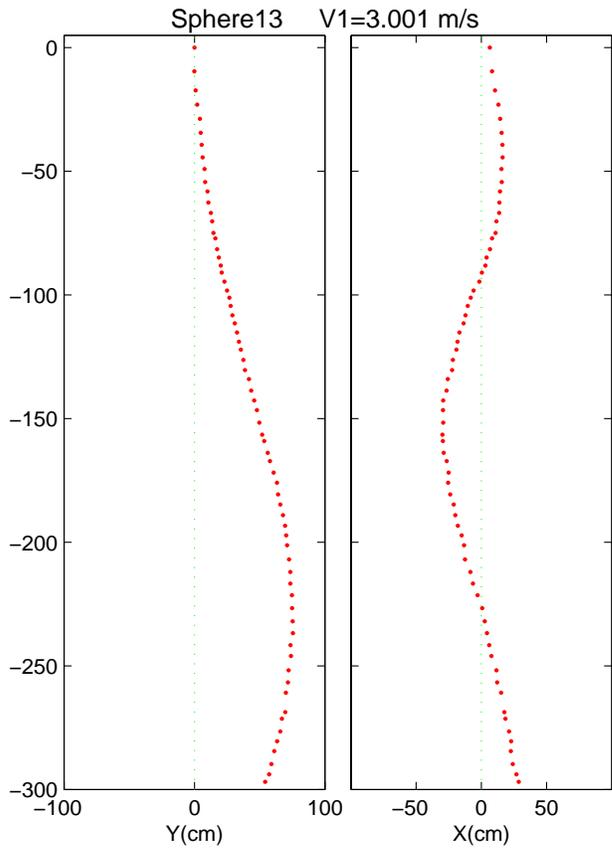

Gumdrop Drop 1

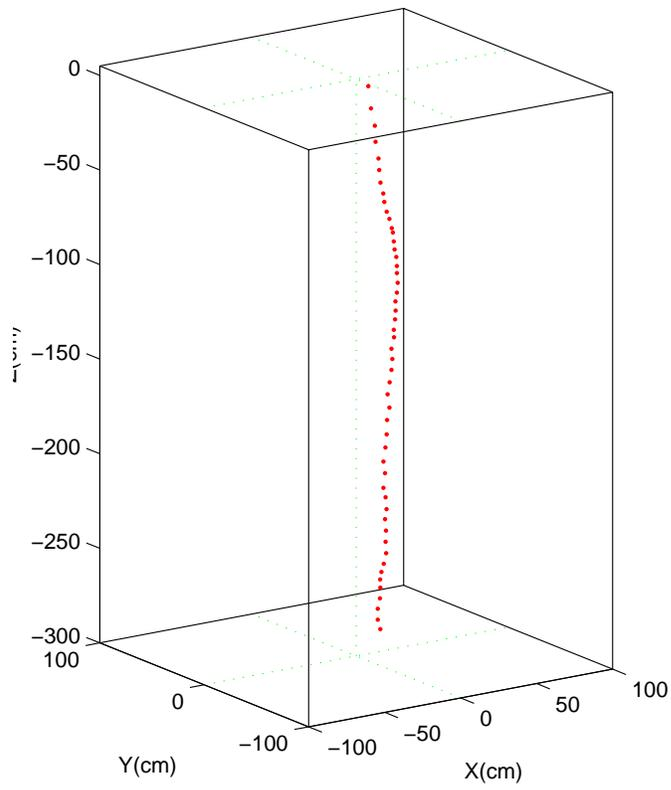
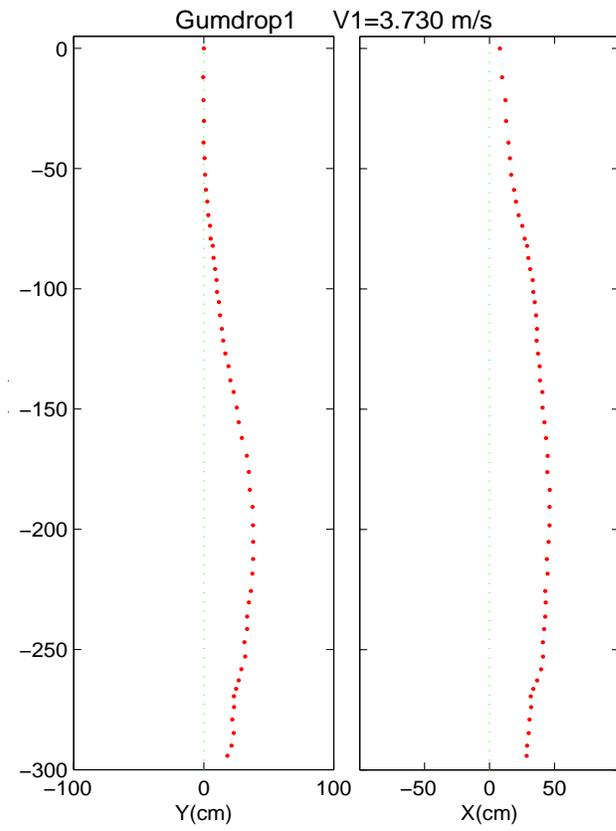

Gumdrop Drop 2

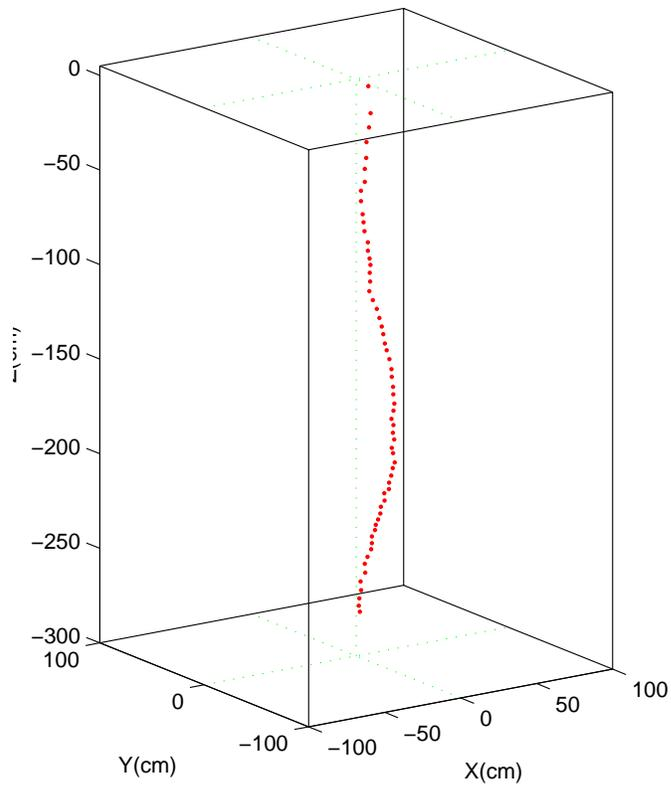
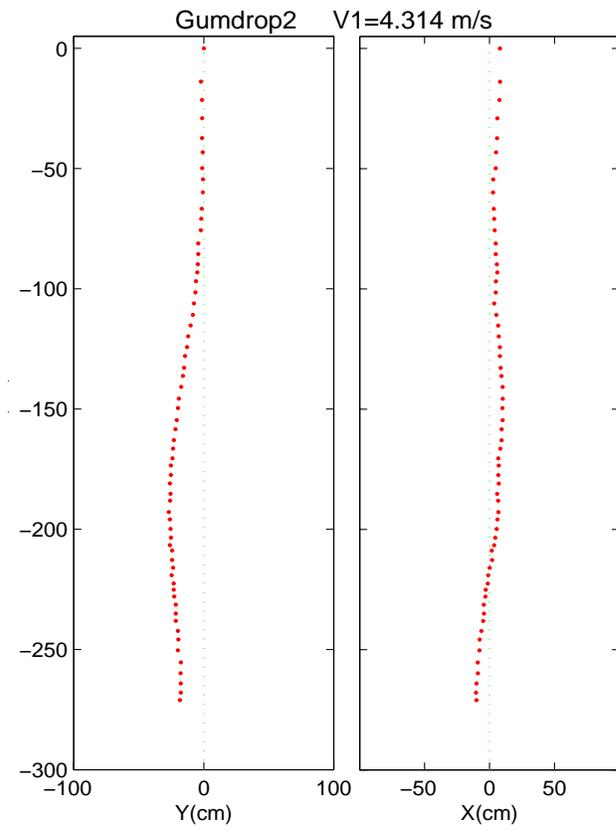

Gumdrop Drop 3

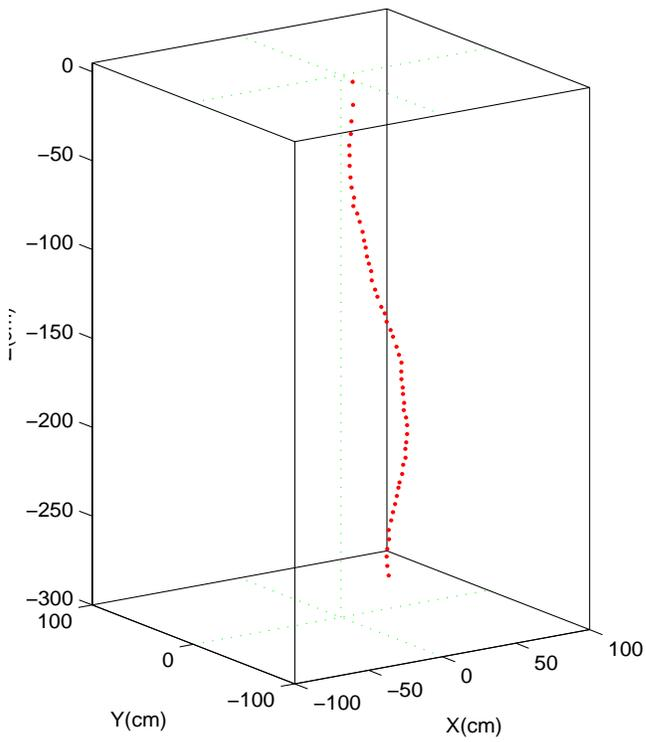
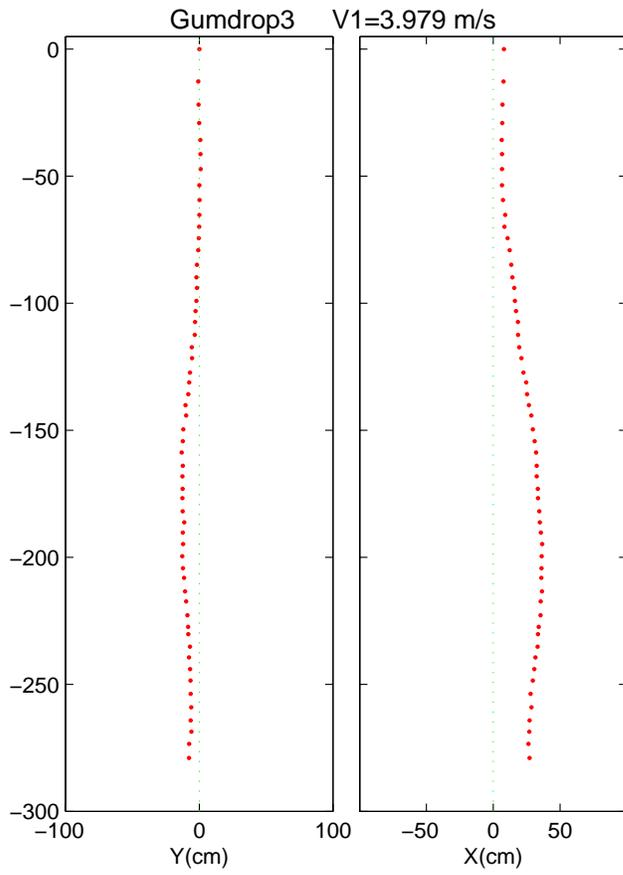

Gumdrop Drop 4

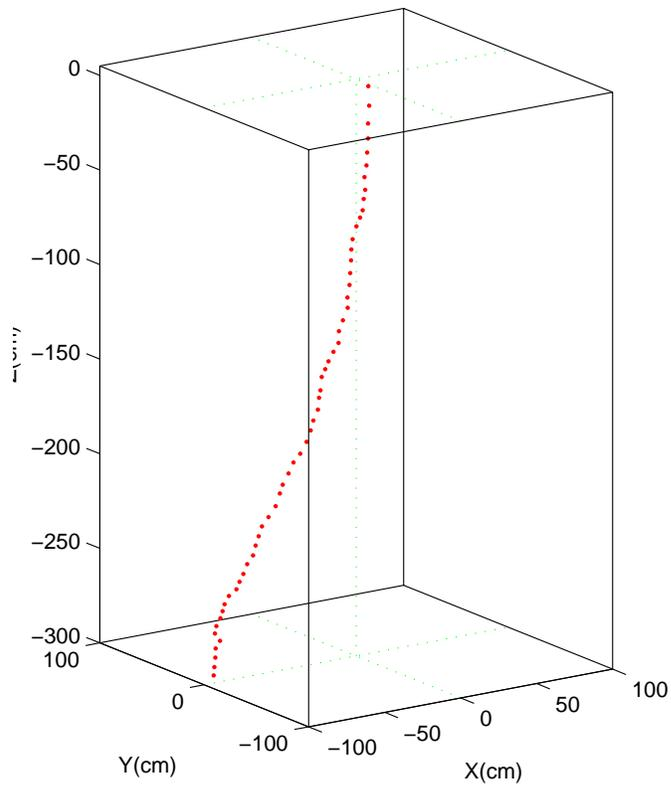
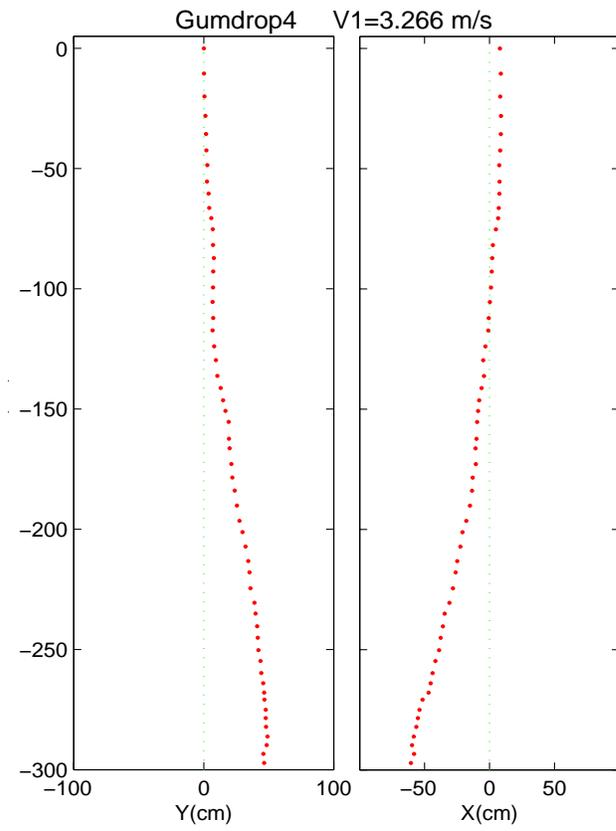

Gumdrop Drop 5

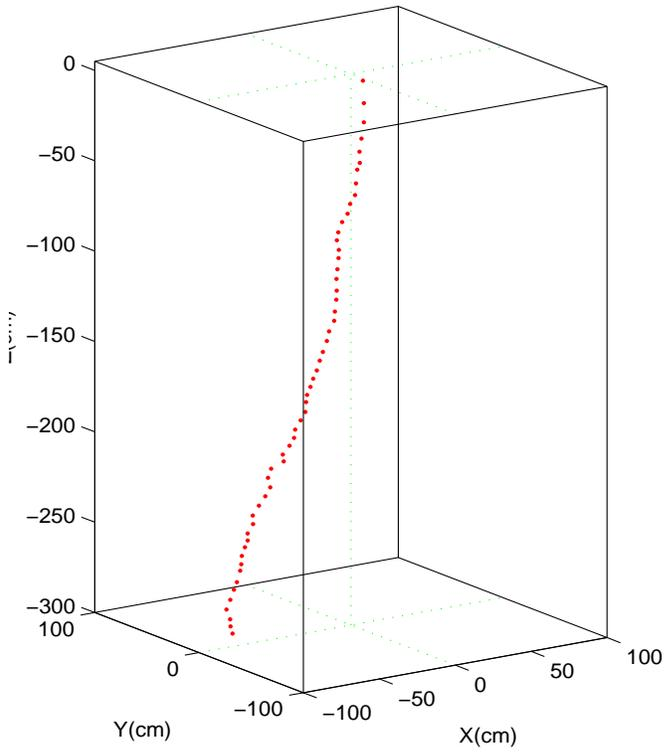
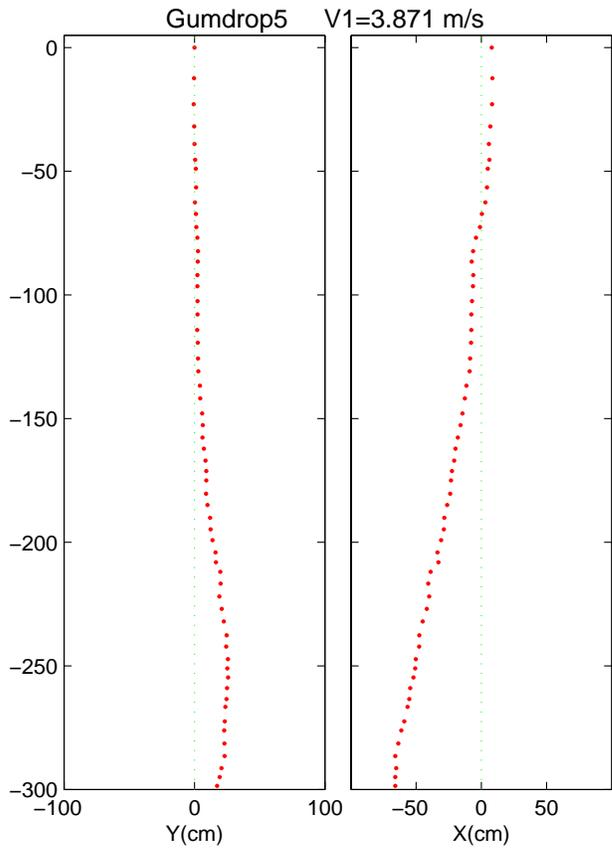

Gumdrop Drop 6

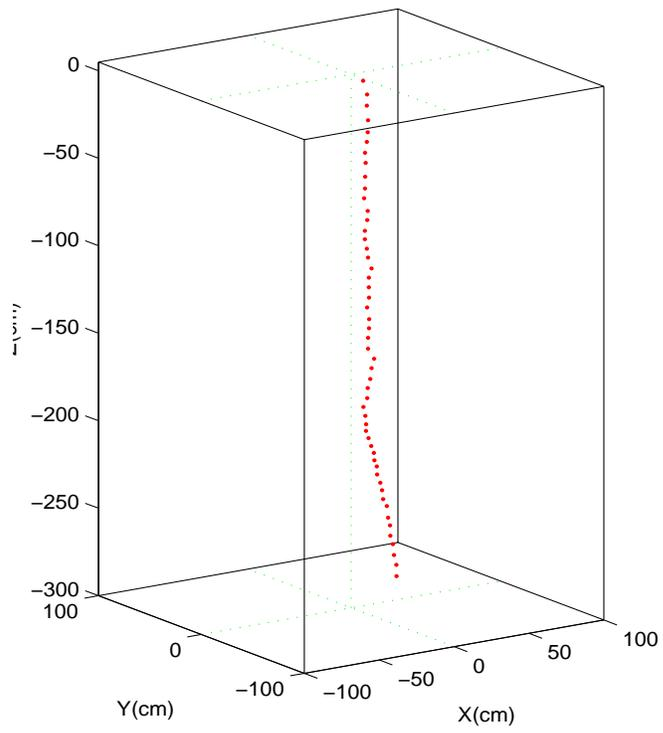
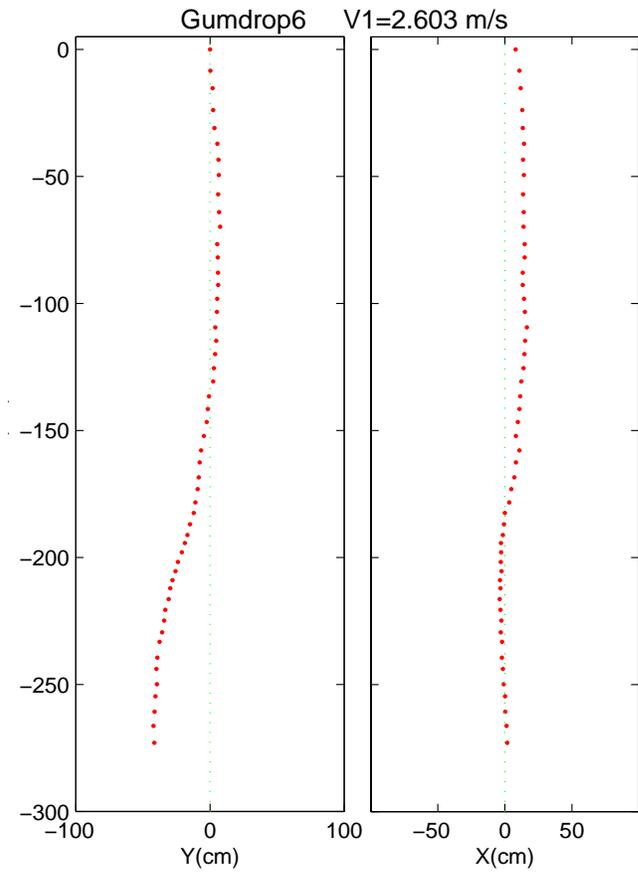

Gumdrop Drop 7

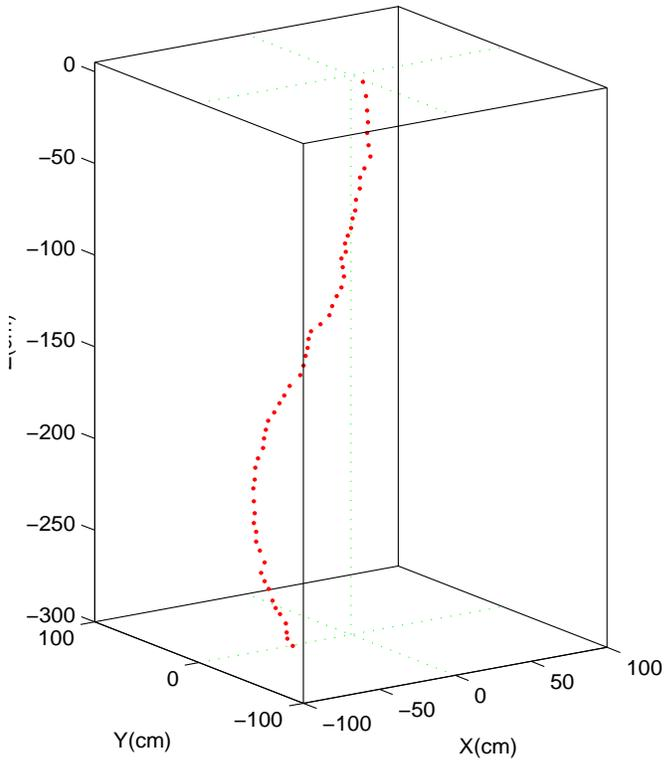
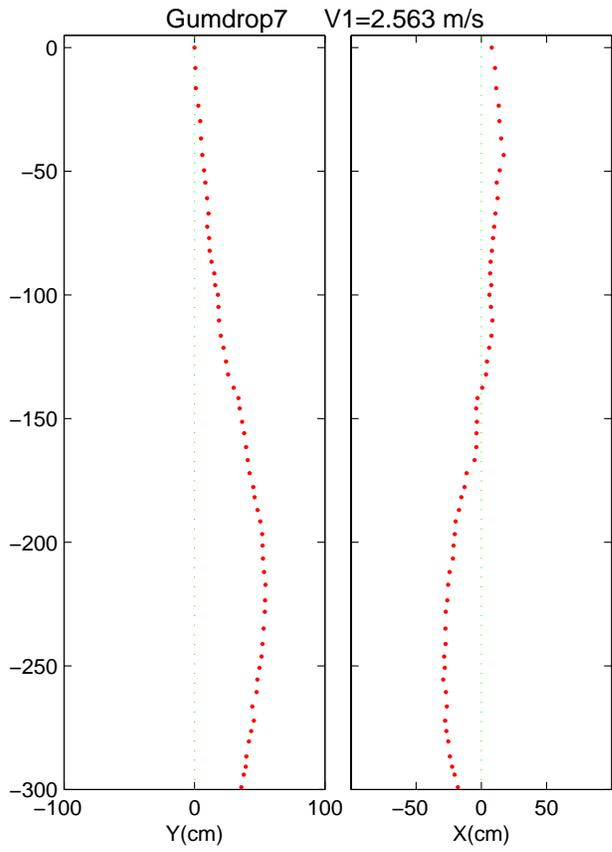

Gumdrop Drop 8

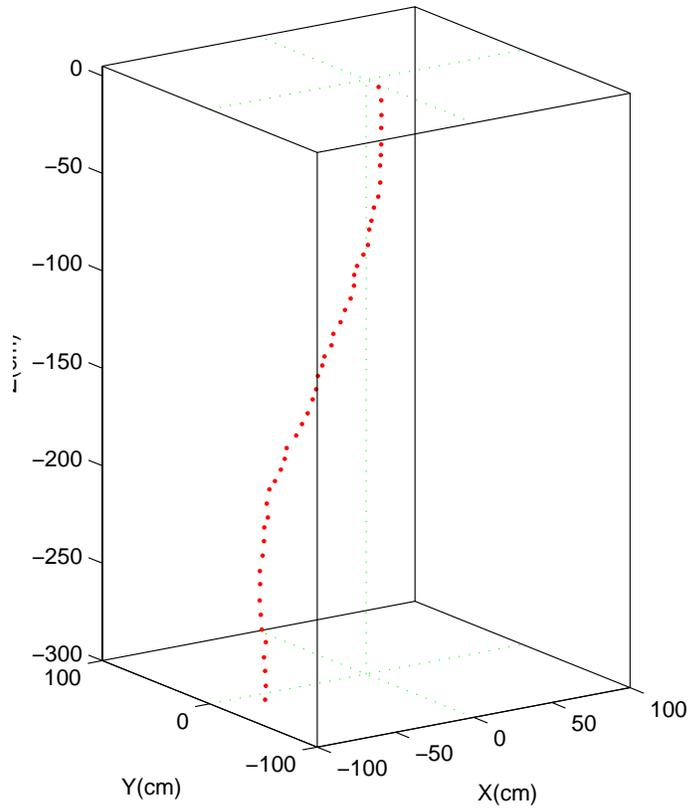
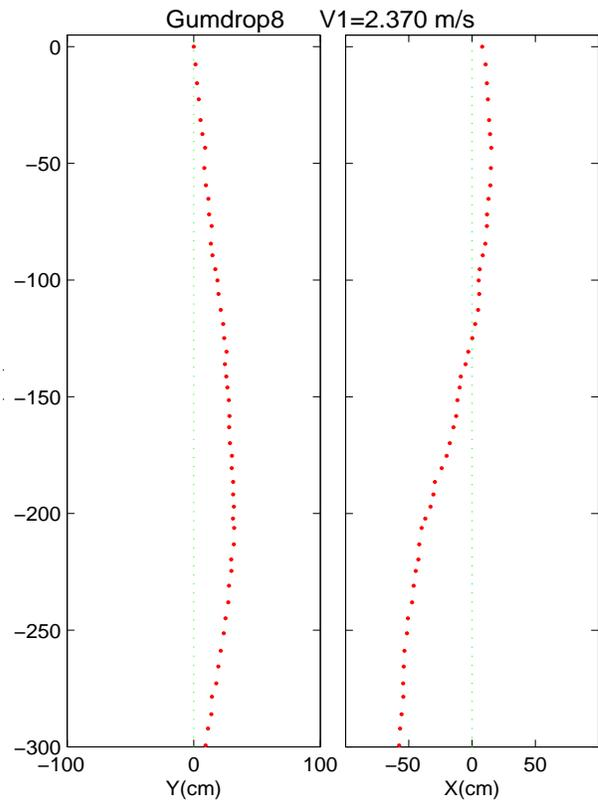

Gumdrop Drop 9

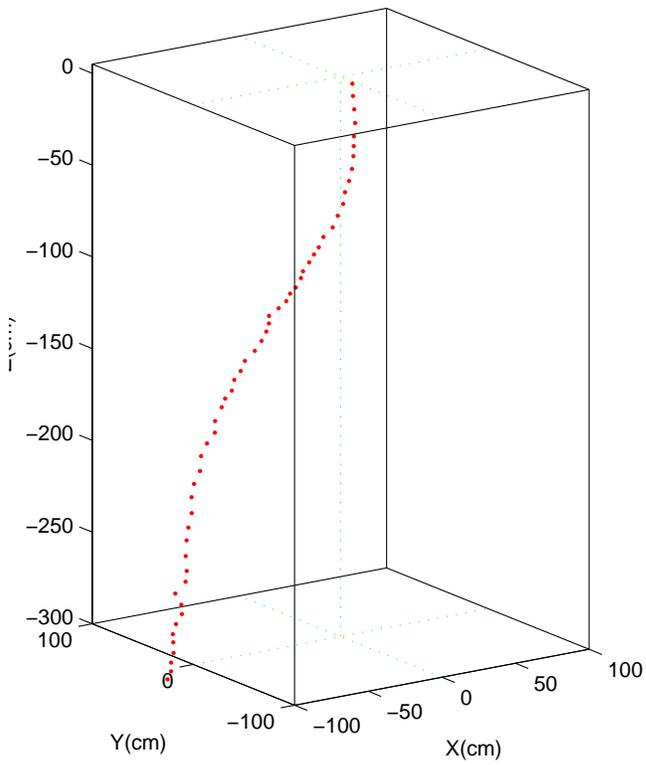
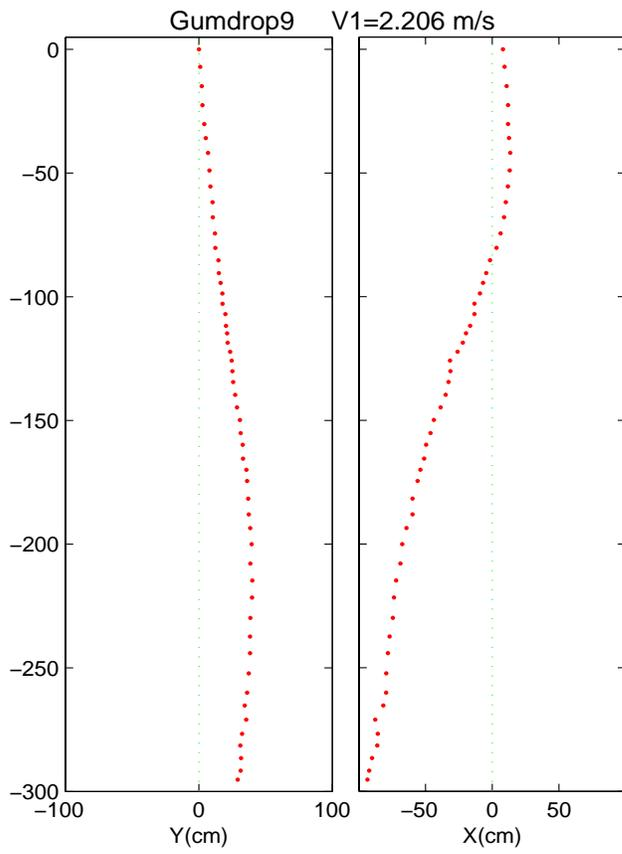

Manta Drop 1

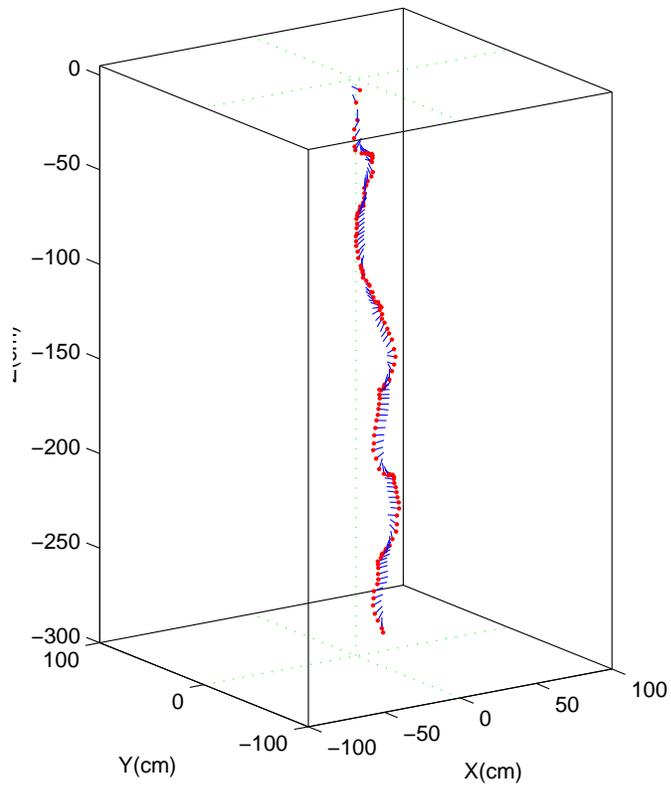
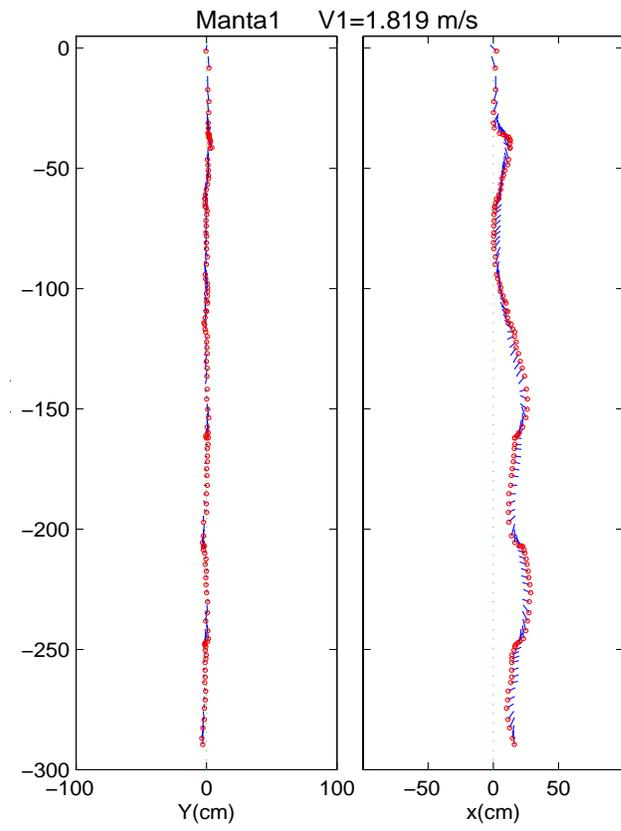

Manta Drop 2

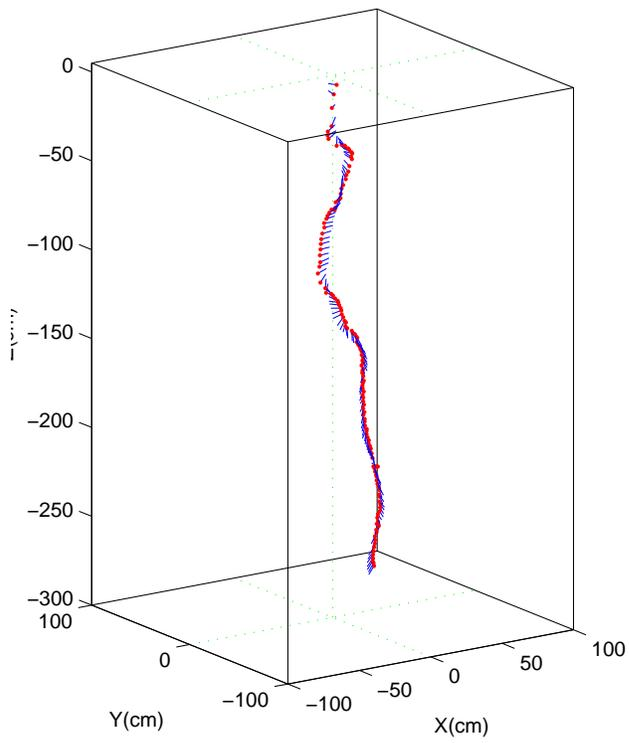
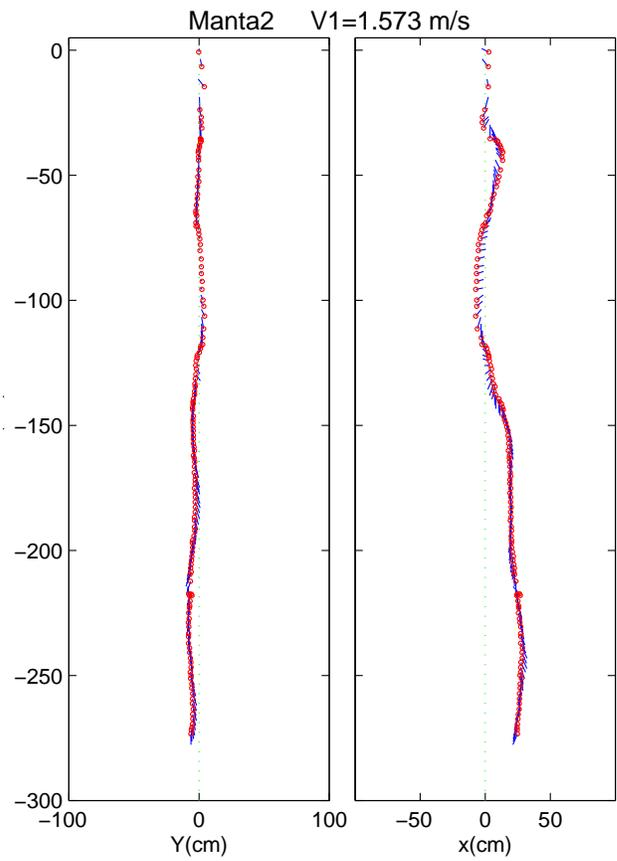

Manta Drop 3

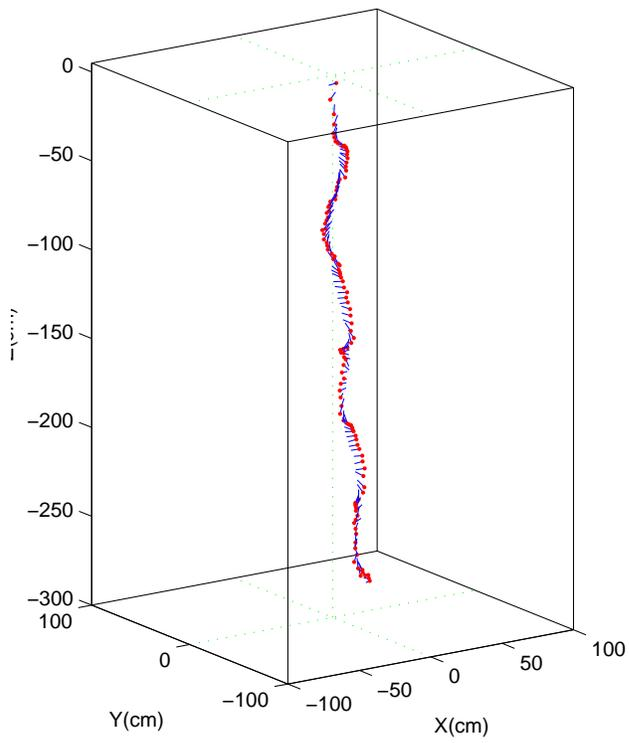
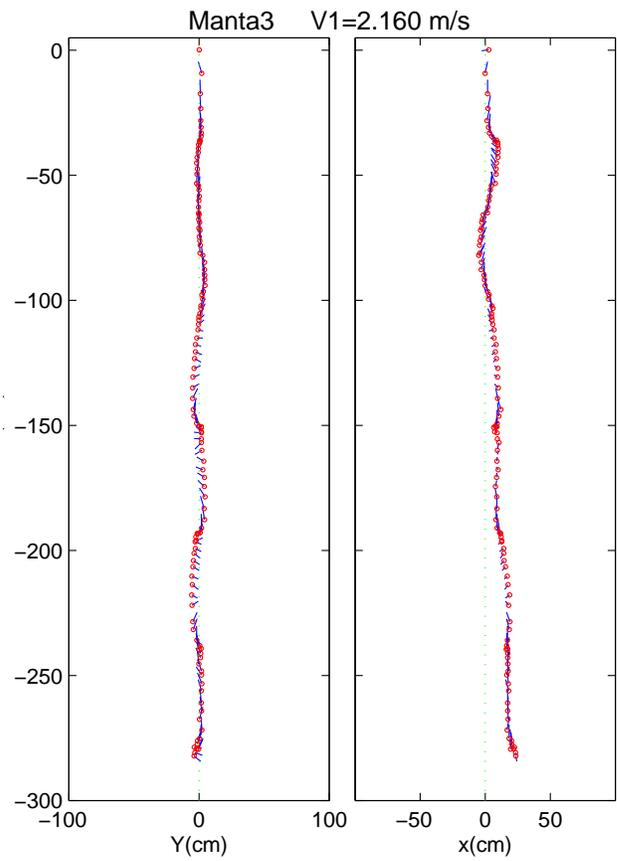

Manta Drop 4

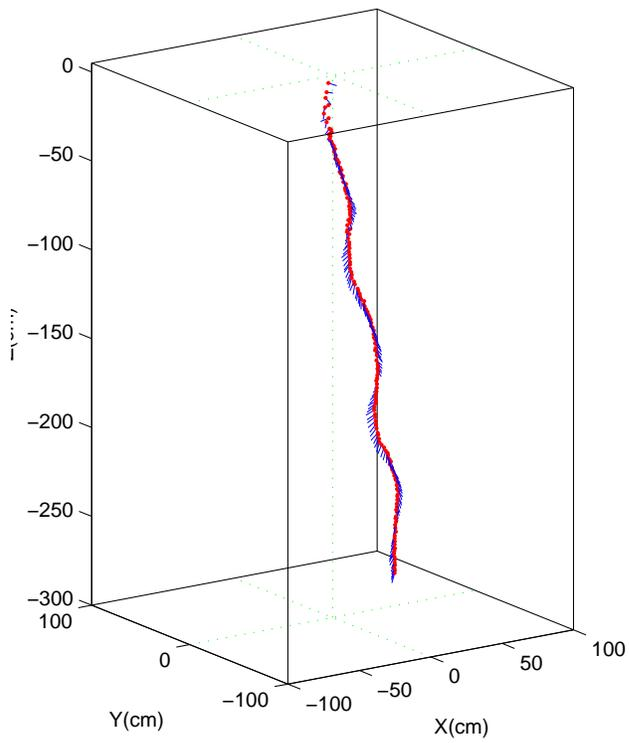
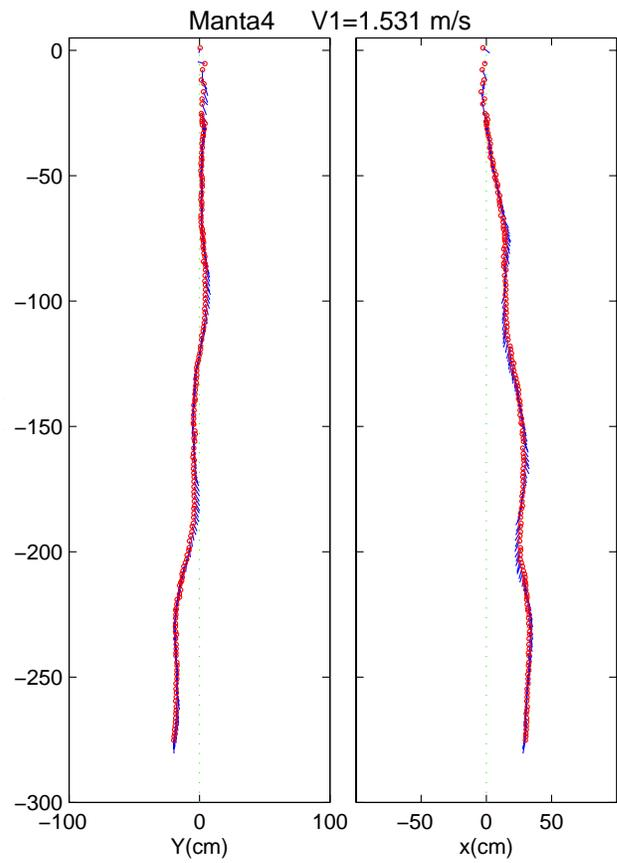

Manta Drop 5

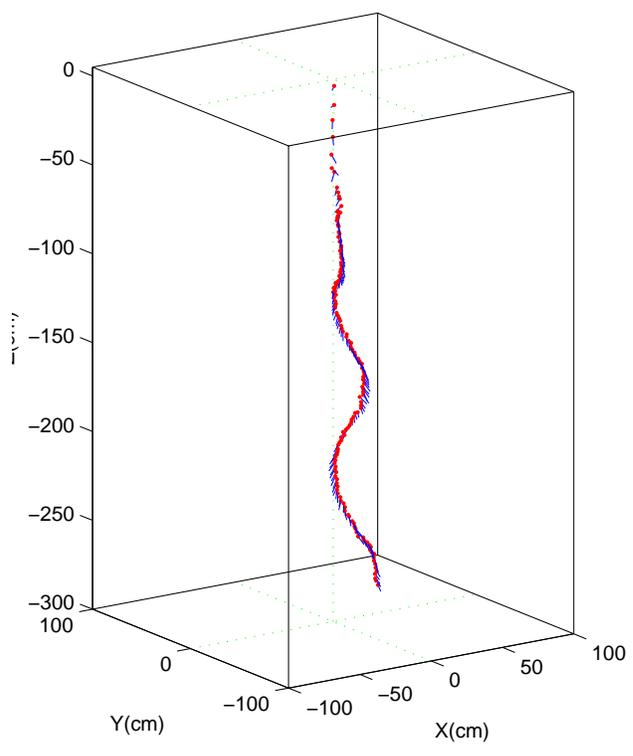
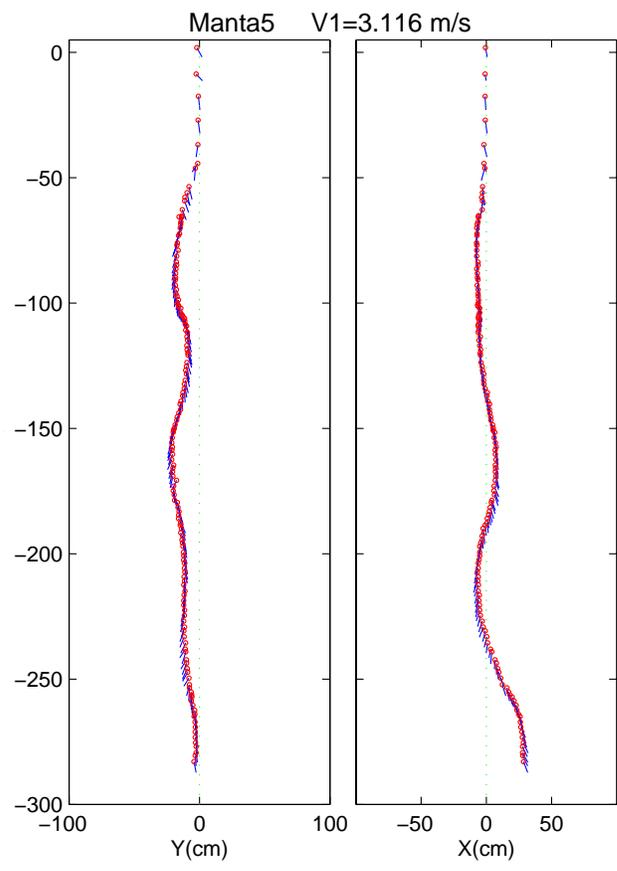

Manta Drop 6

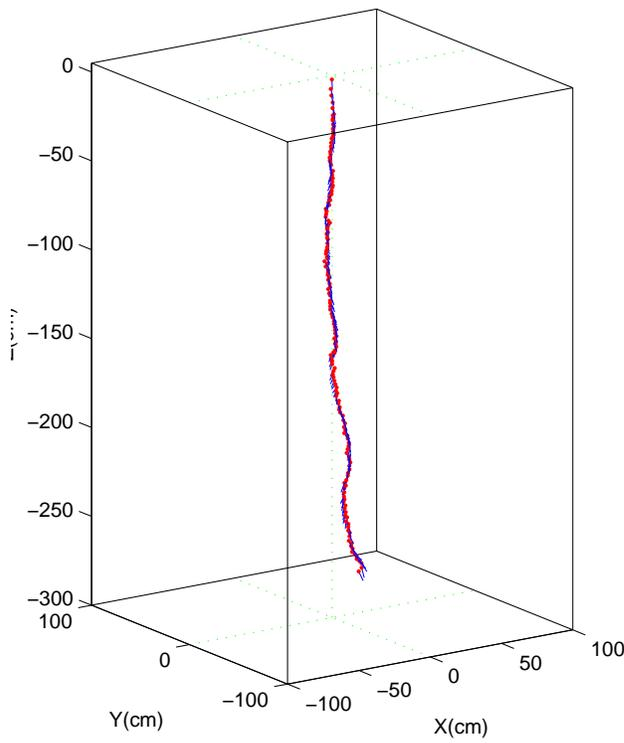
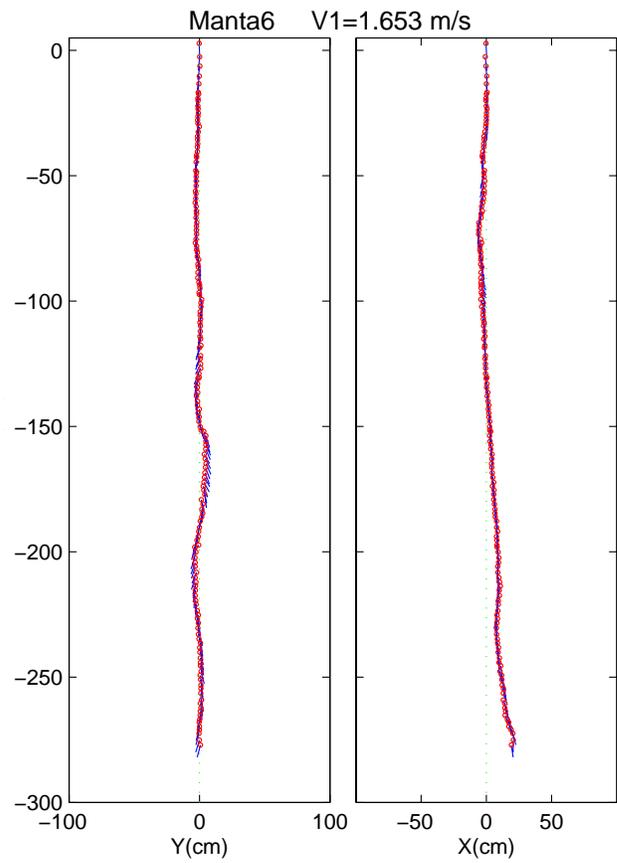

Manta Drop 7

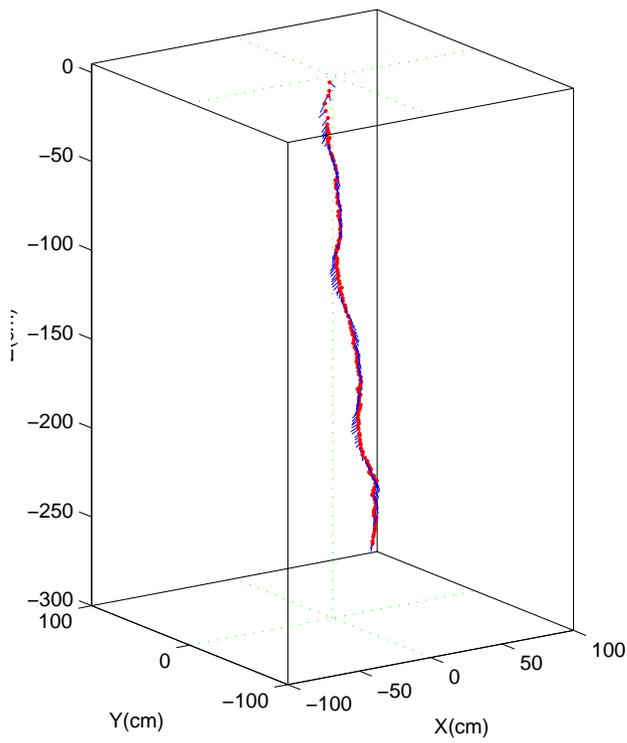
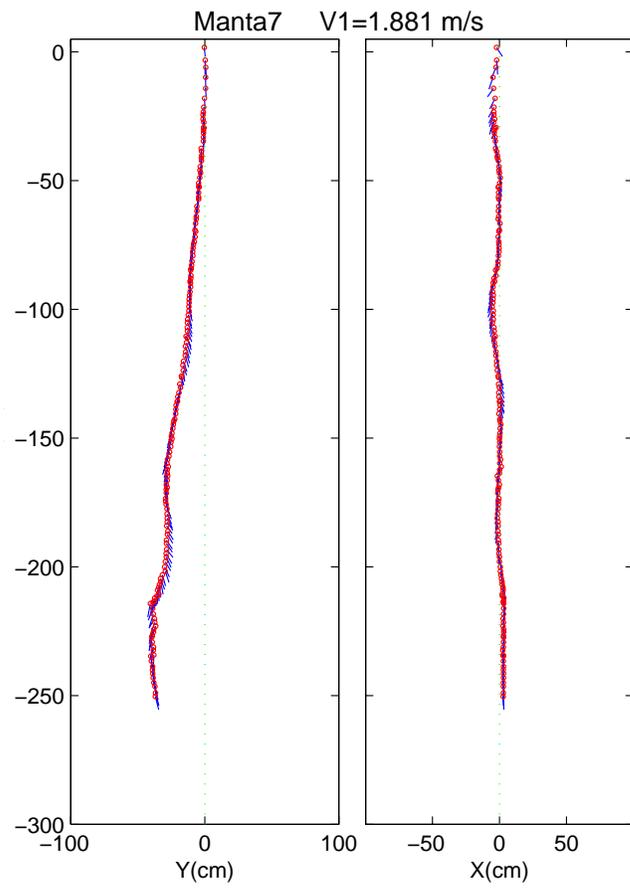

Manta Drop 8

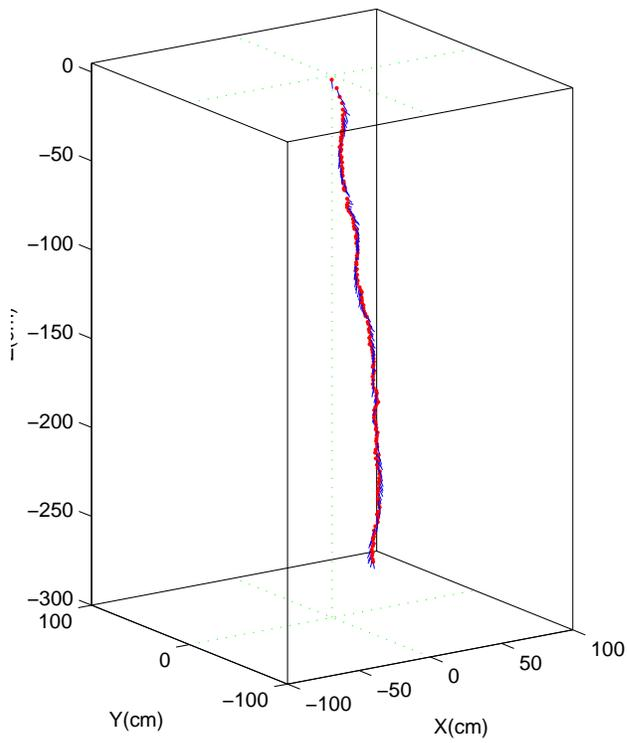
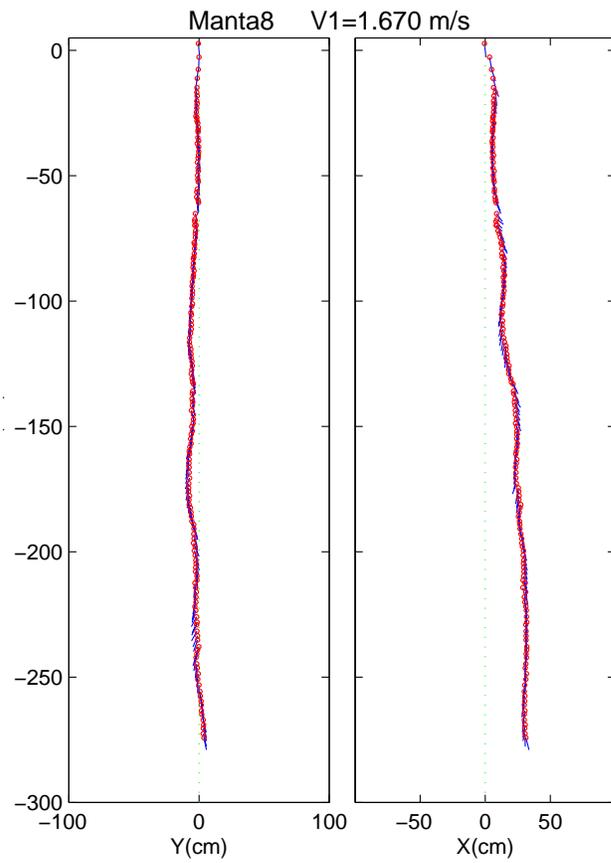

Manta Drop 9

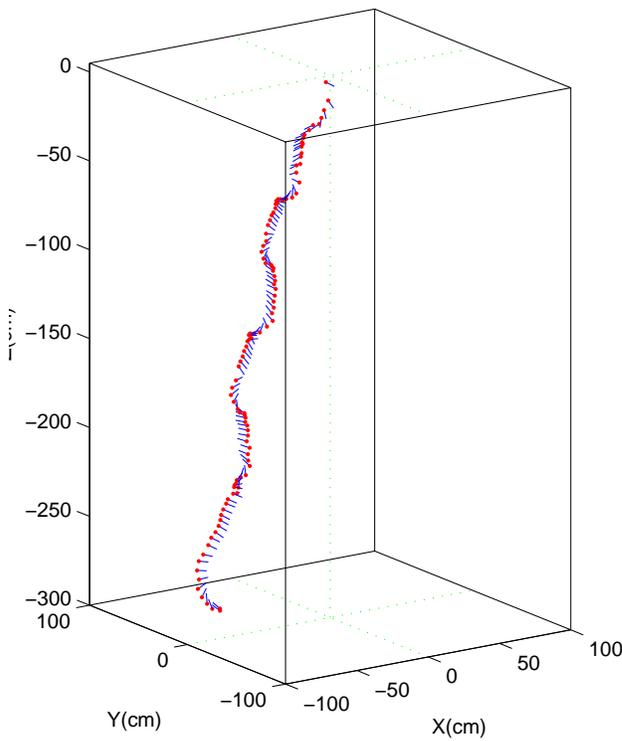
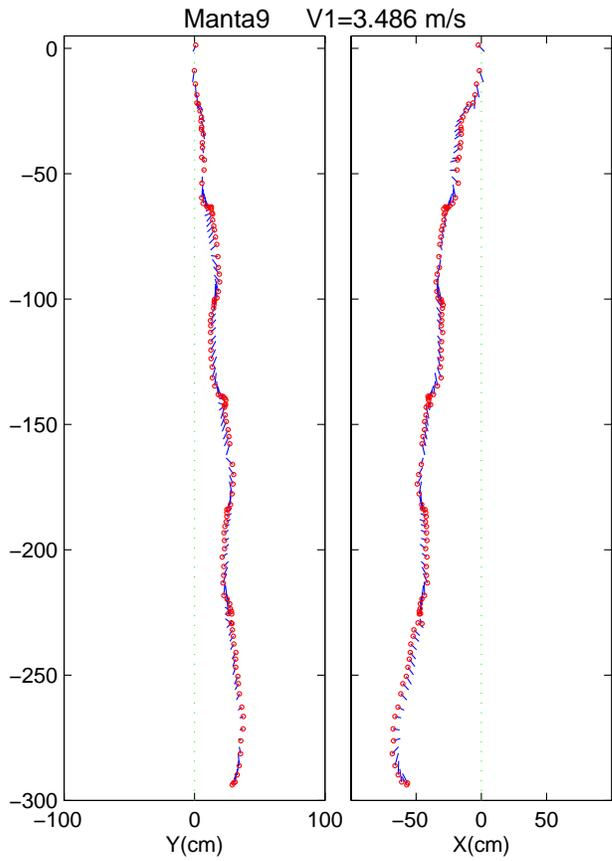

Manta Drop 10

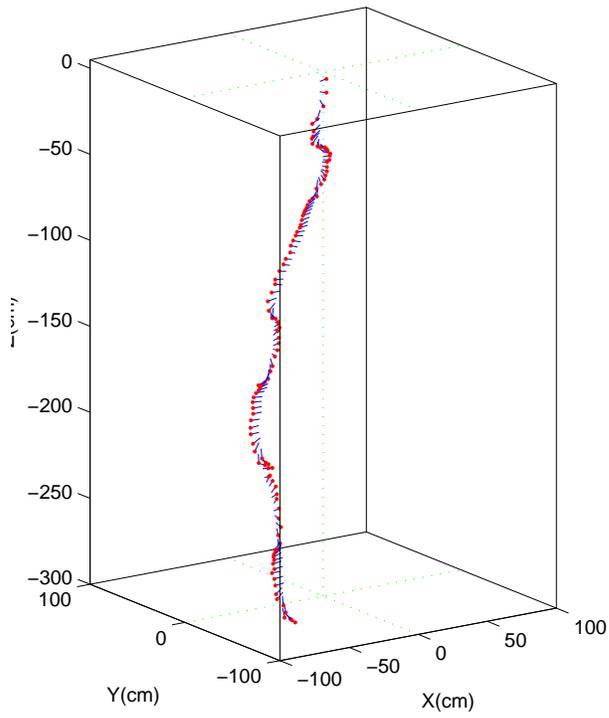
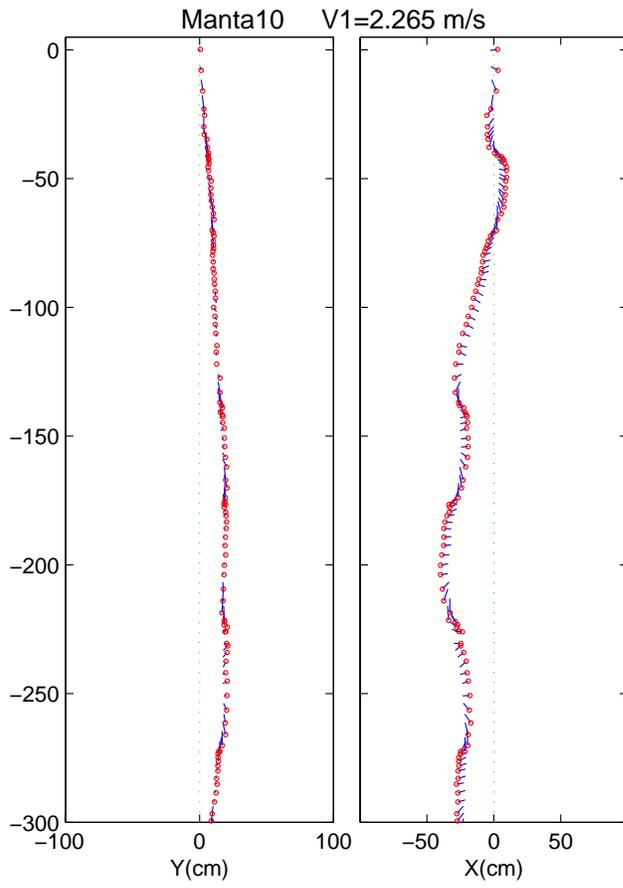

Manta Drop 11

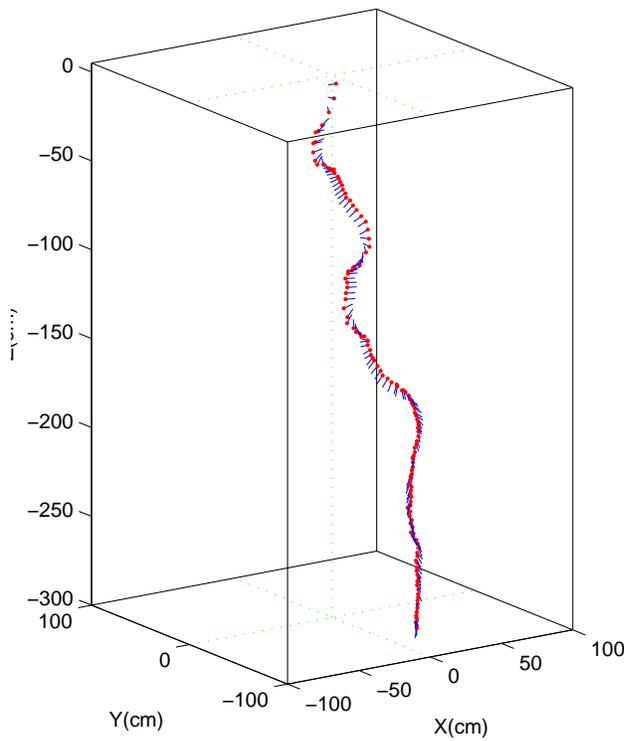
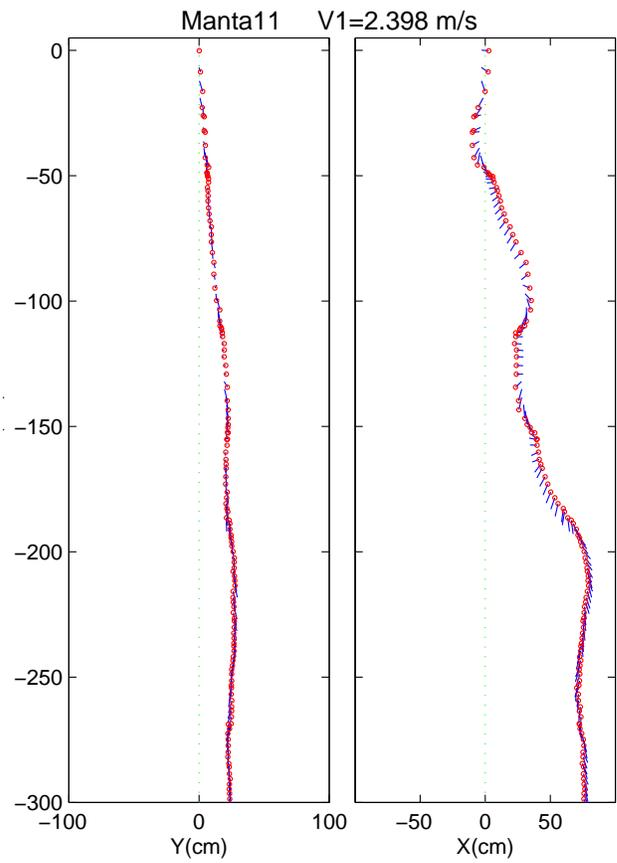

Manta Drop 12

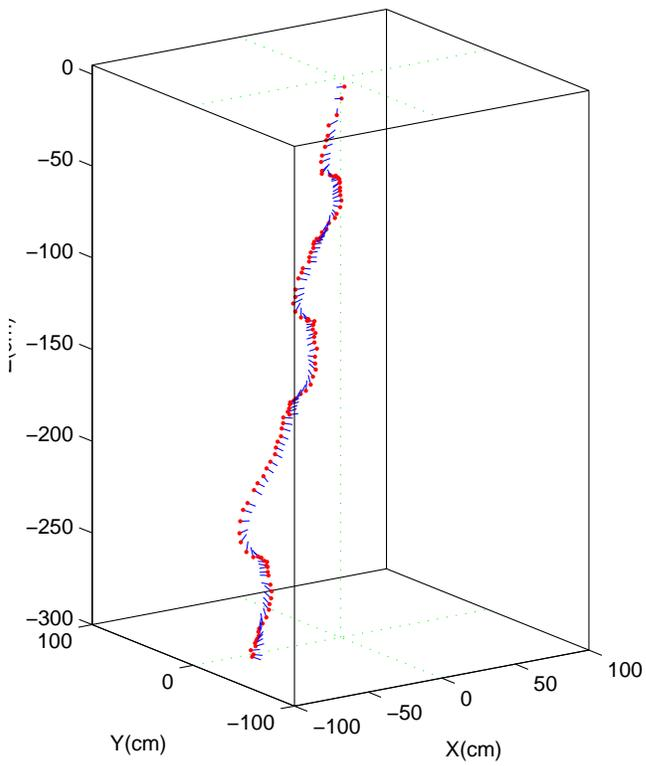
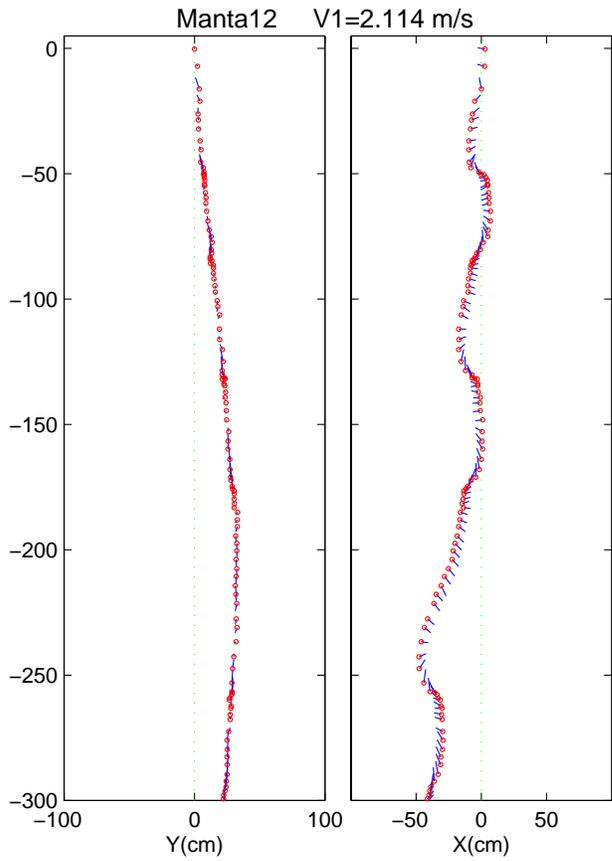

Manta Drop 13

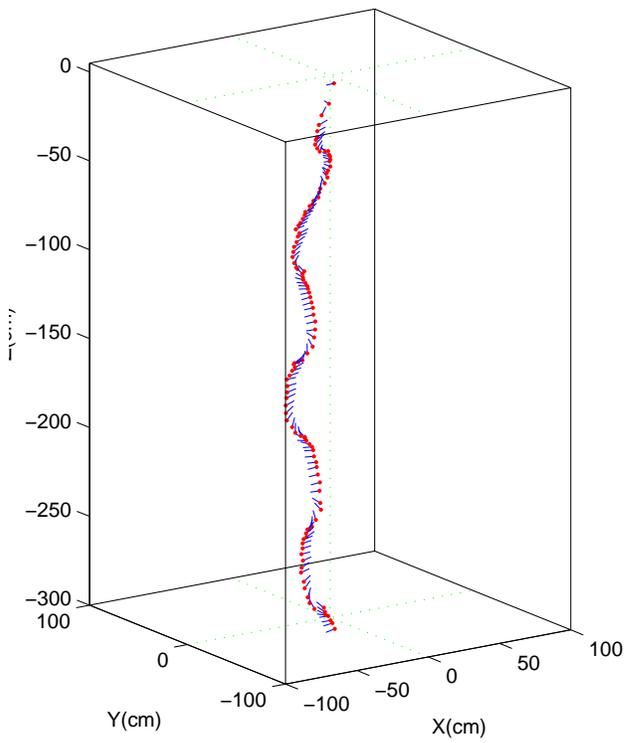
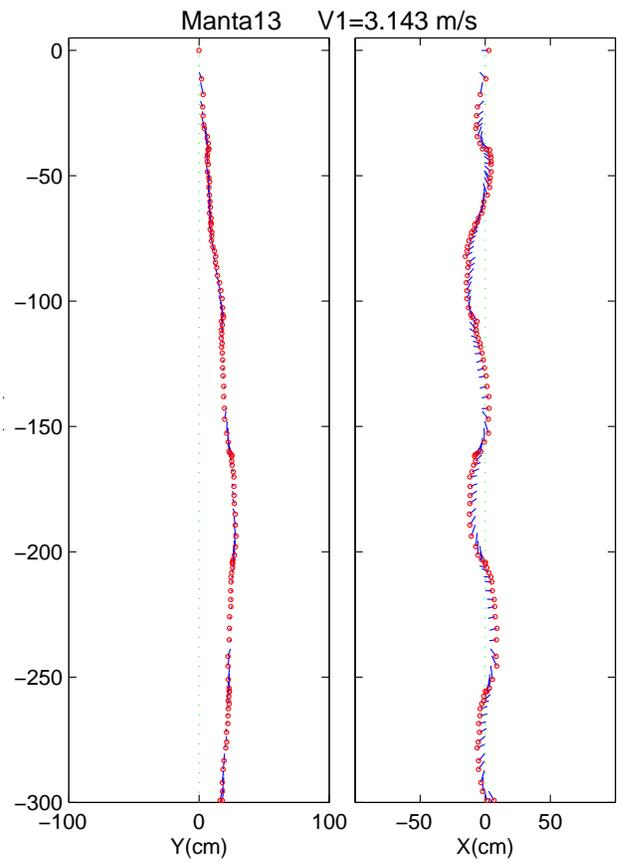

Manta Drop 14

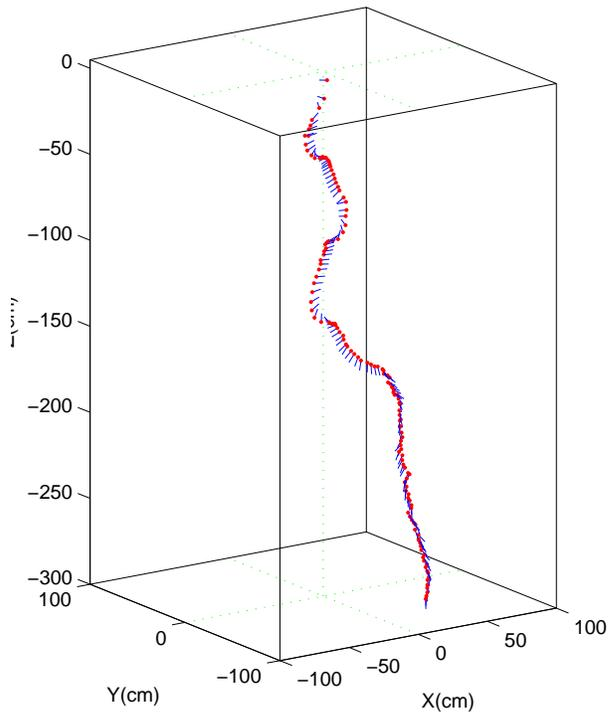
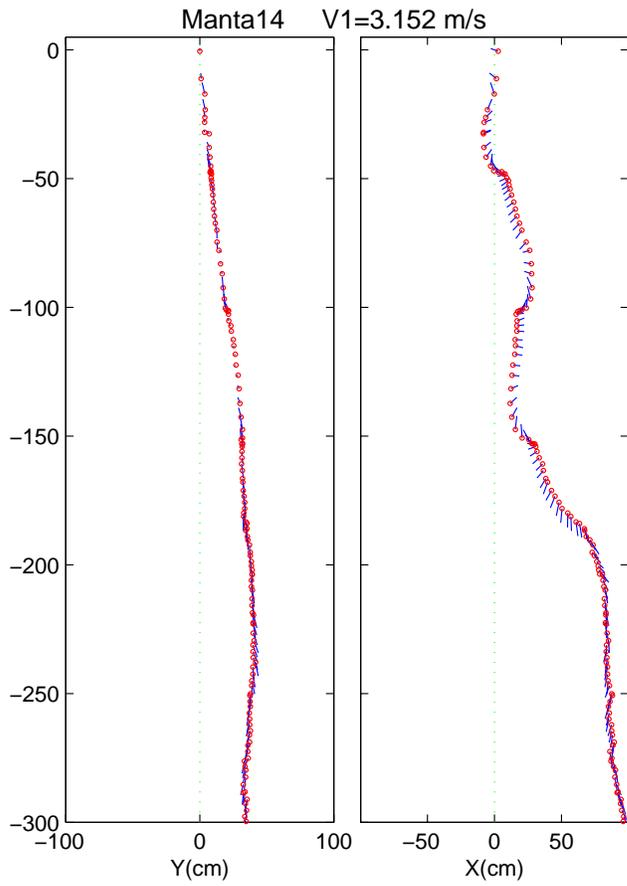

Manta Drop 15

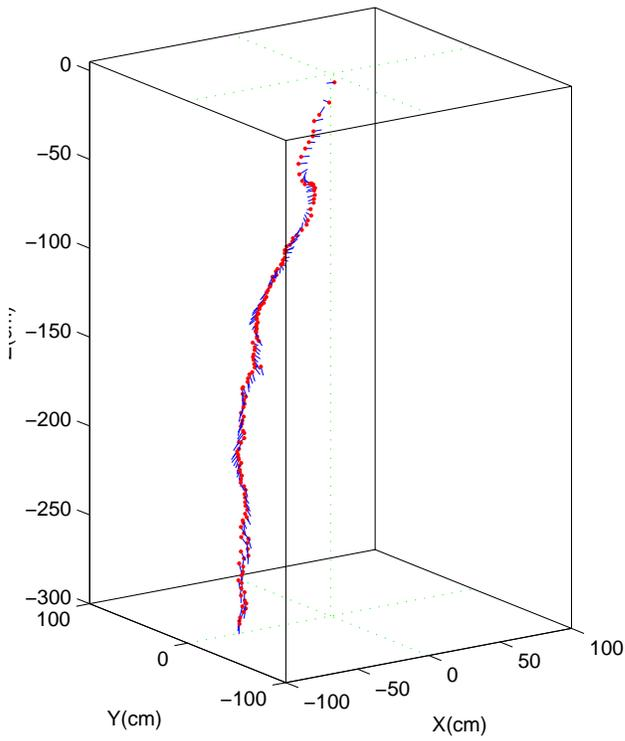
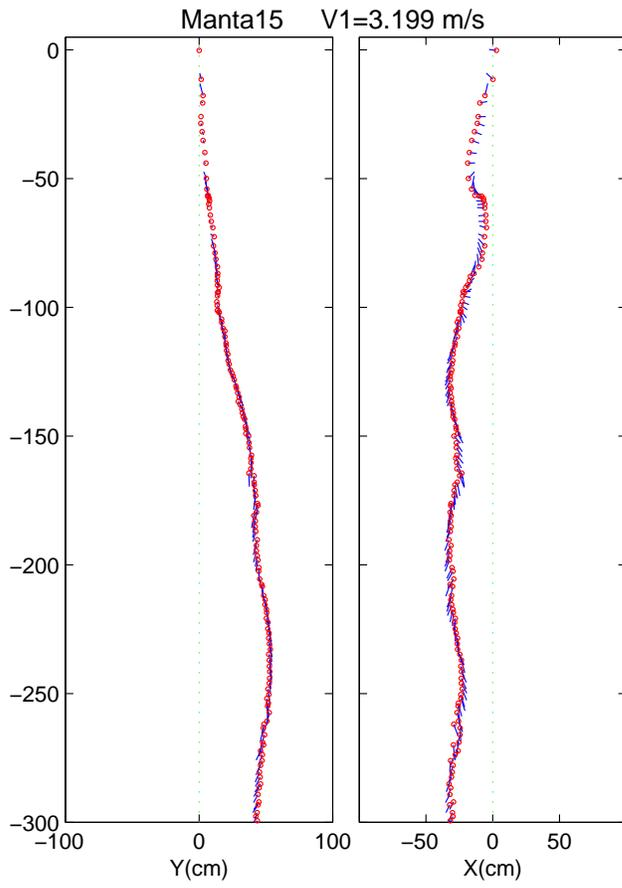

Rockan Drop 1

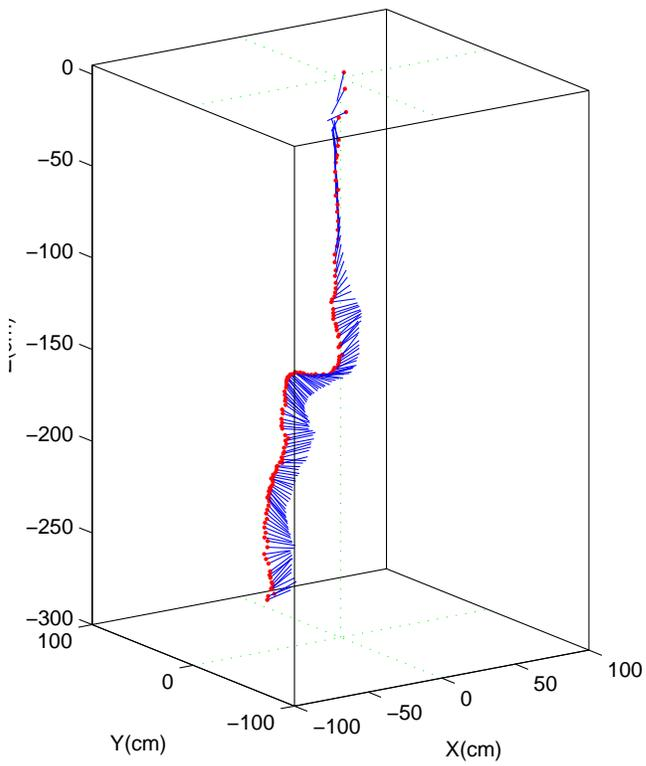
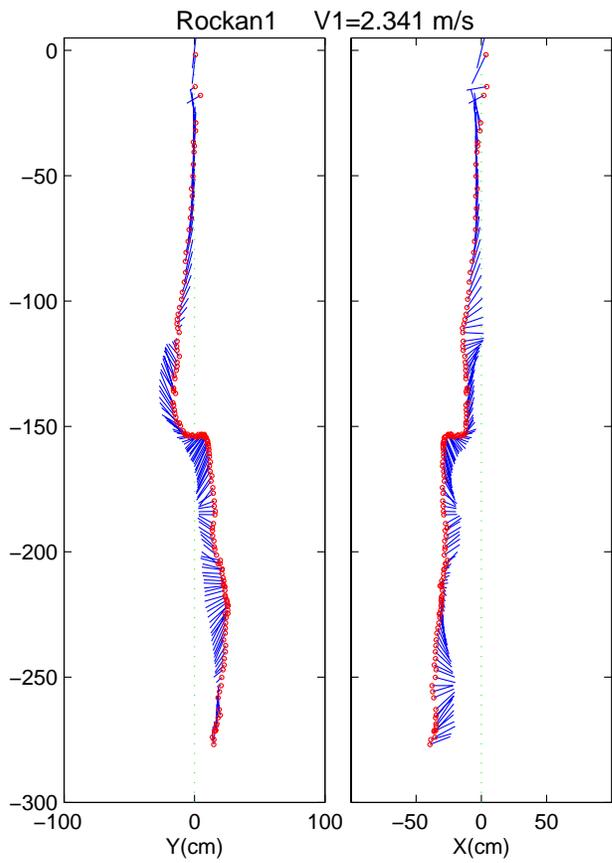

Rockan Drop 2

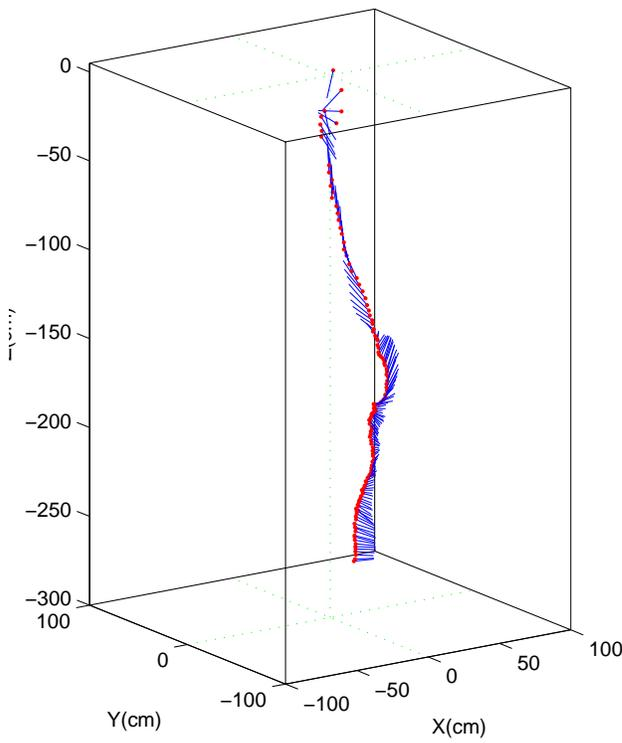
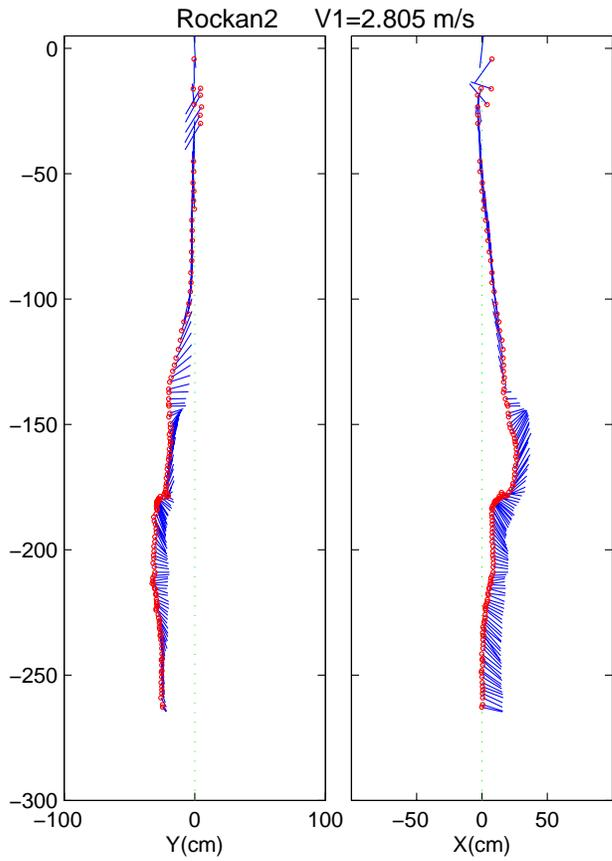

Rockan Drop 3

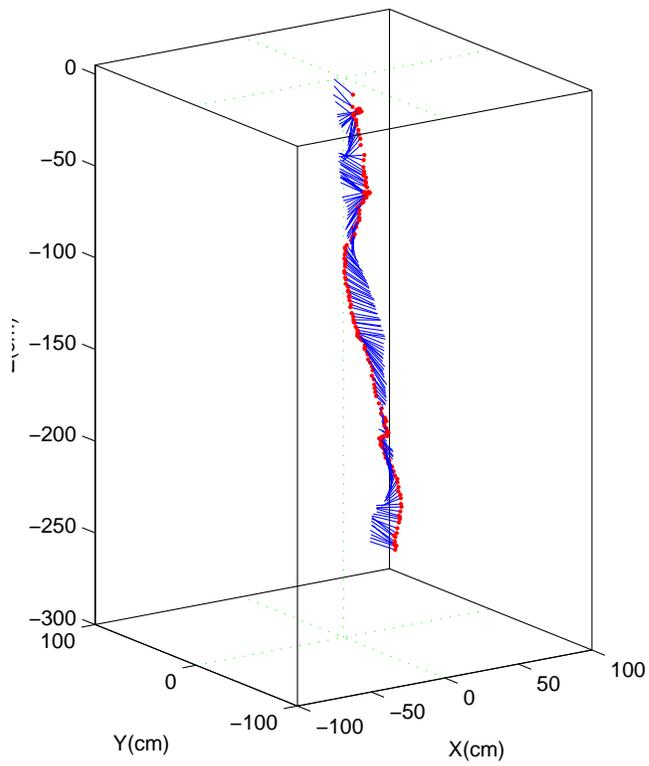
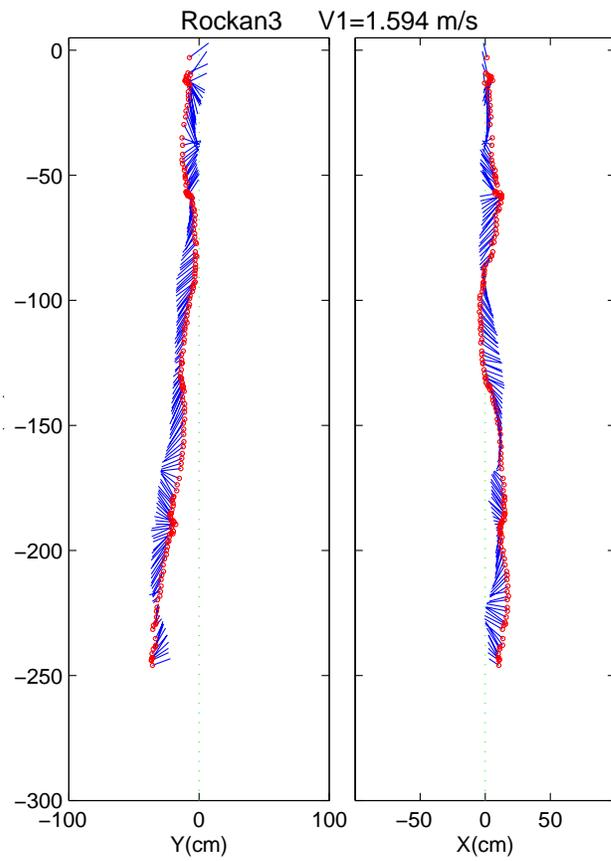

Rockan Drop 4

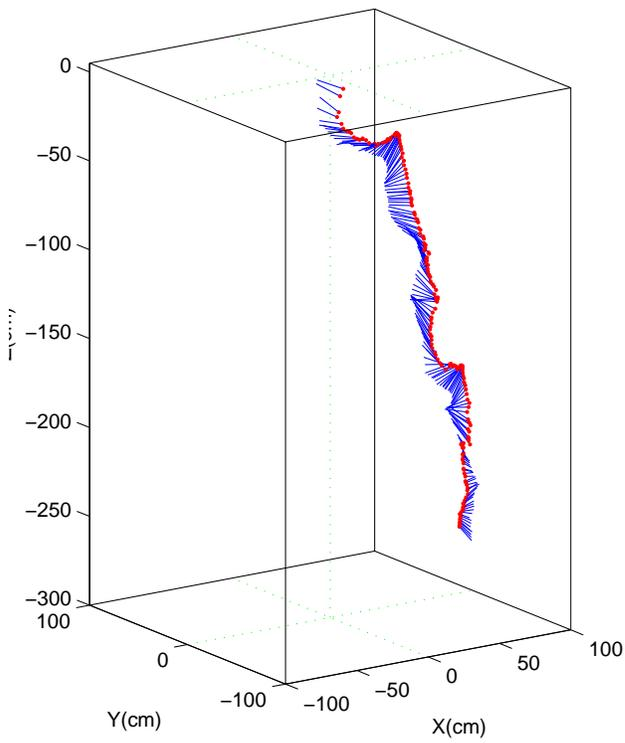
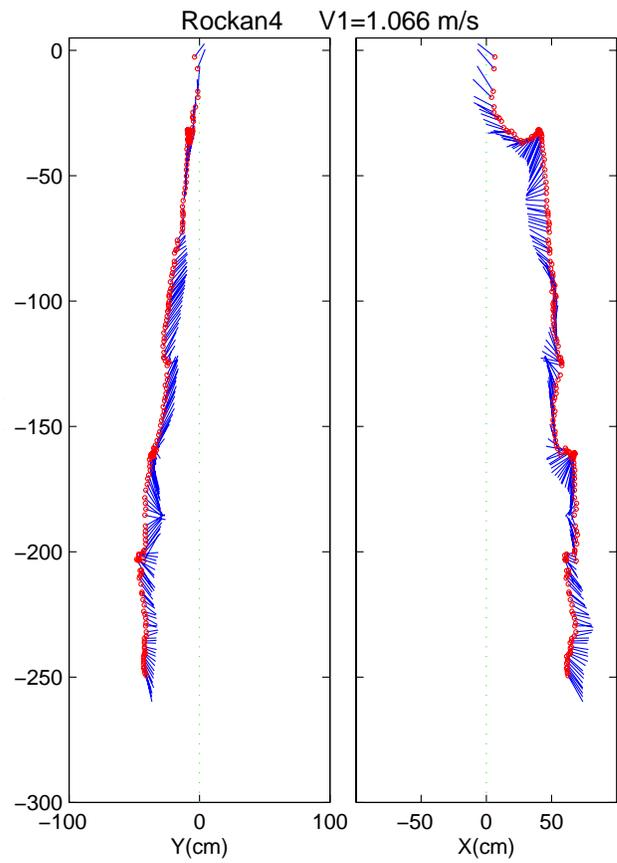

Rockan Drop 5

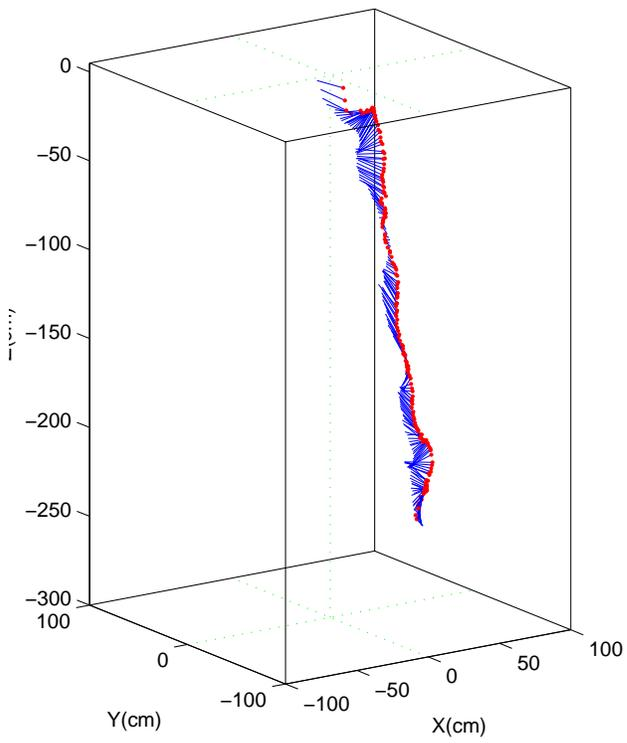
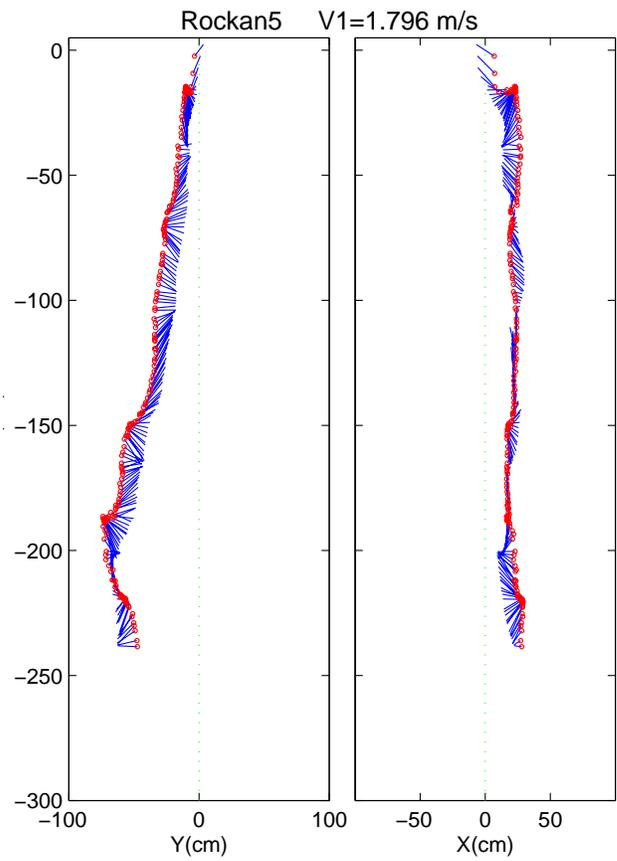

Rockan Drop 6

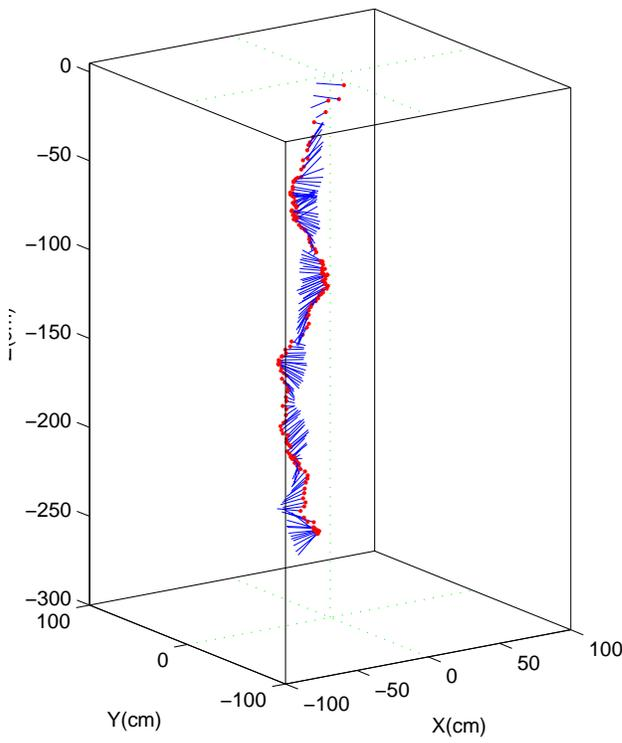
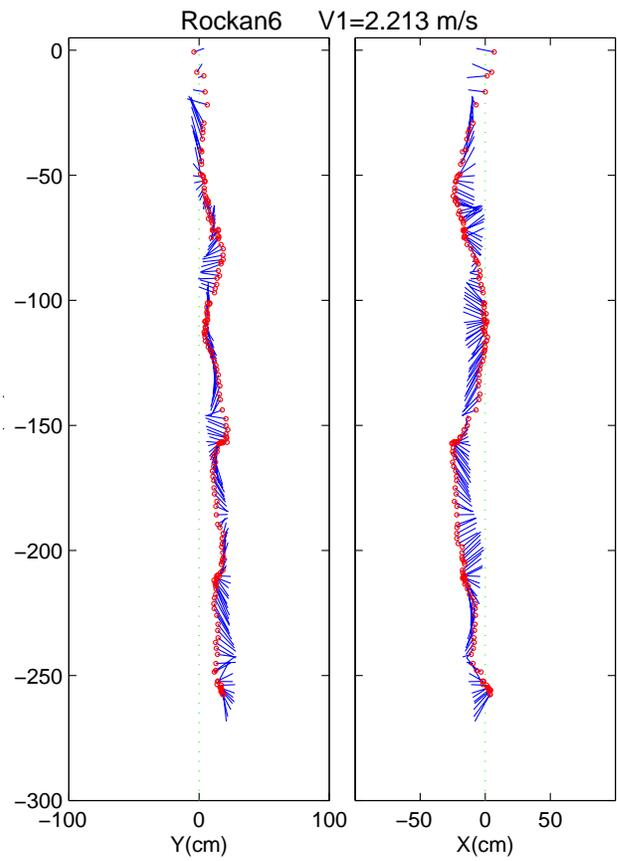

Rockan Drop 7

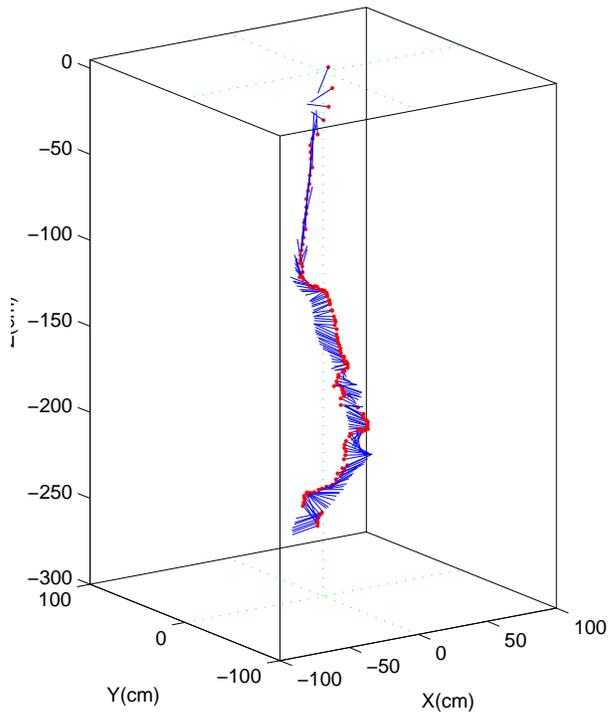
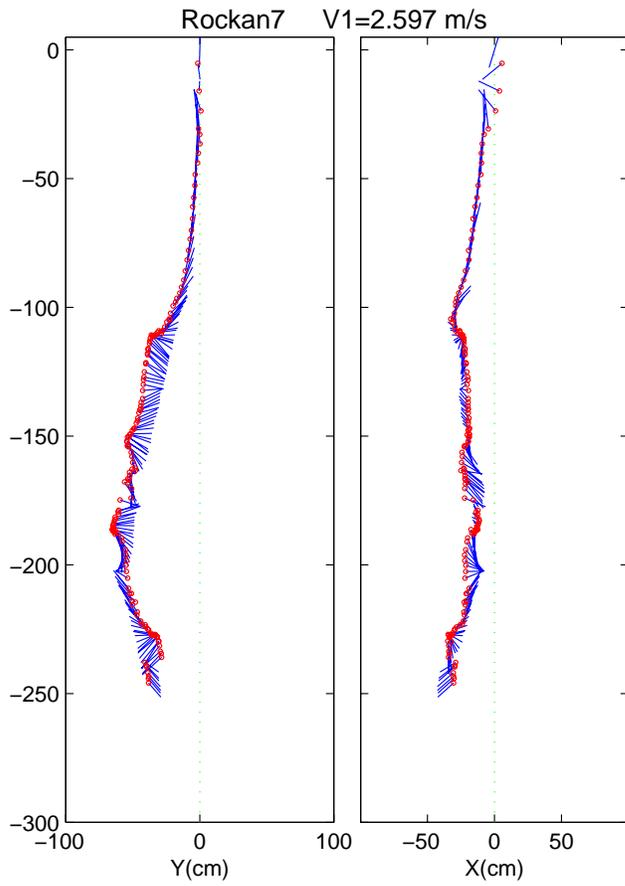

Rockan Drop 8

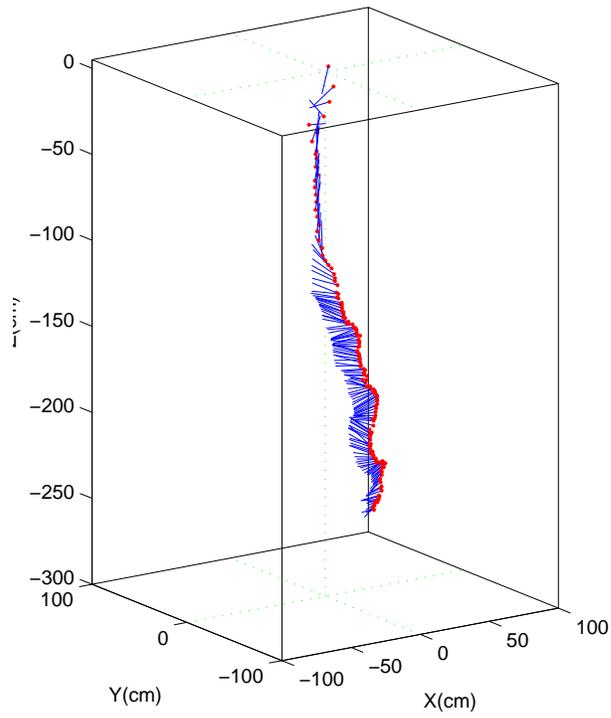
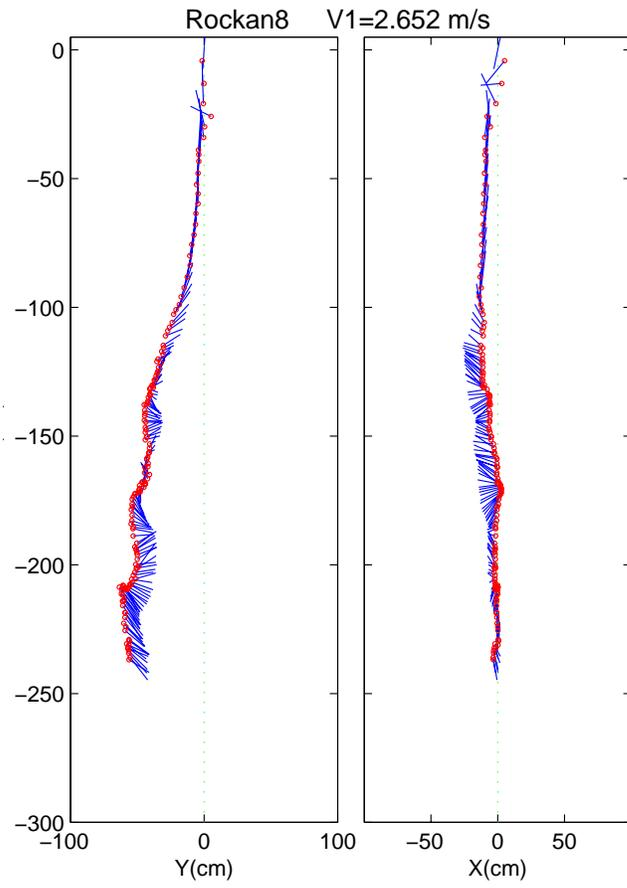

Rockan Drop 9

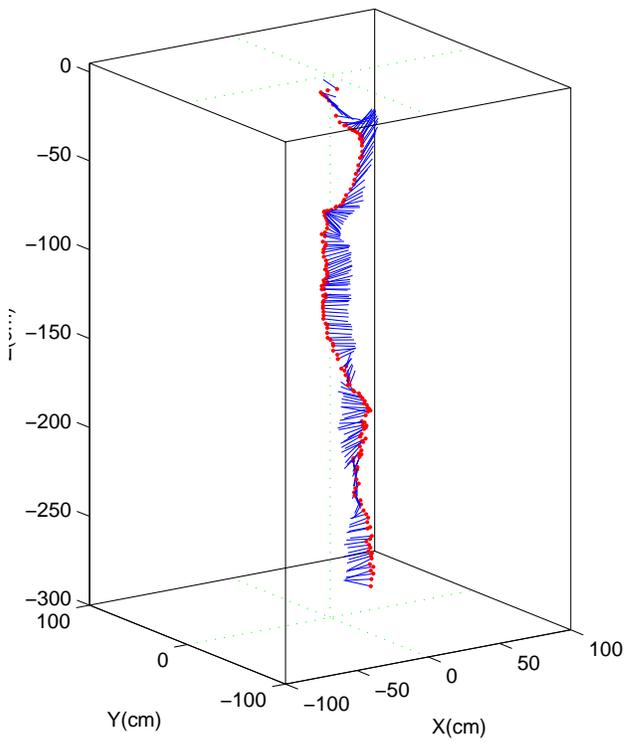
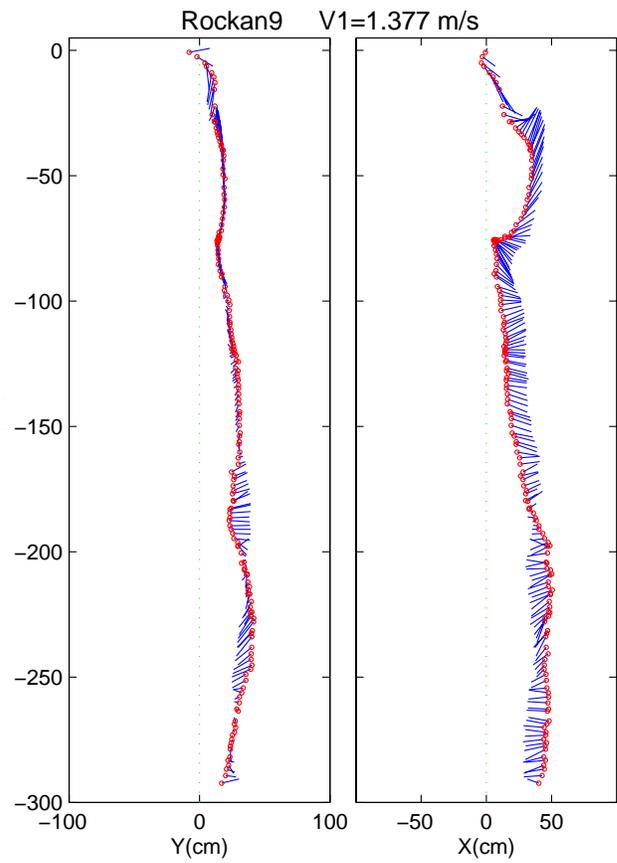

Rockan Drop 10

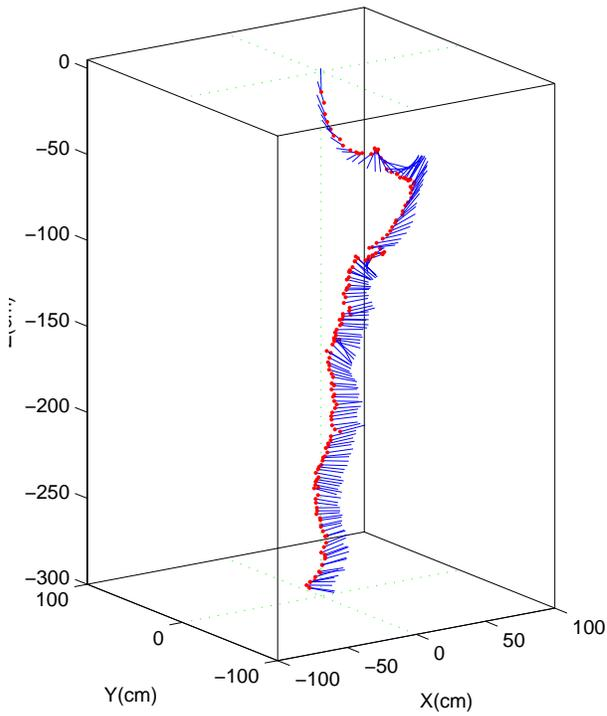
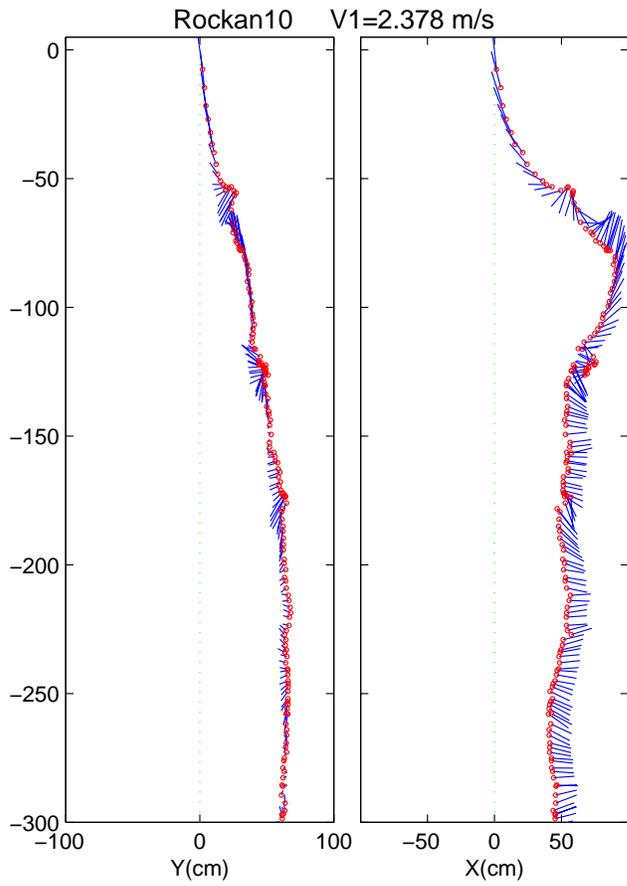

Rockan Drop 11

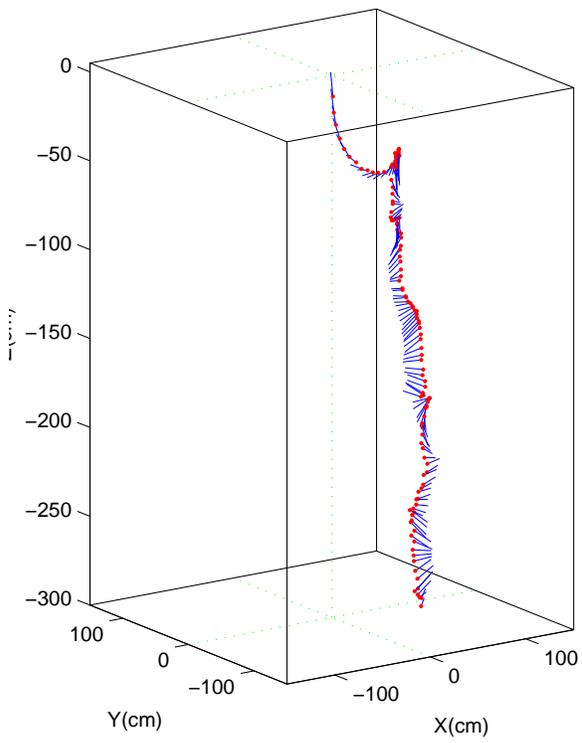
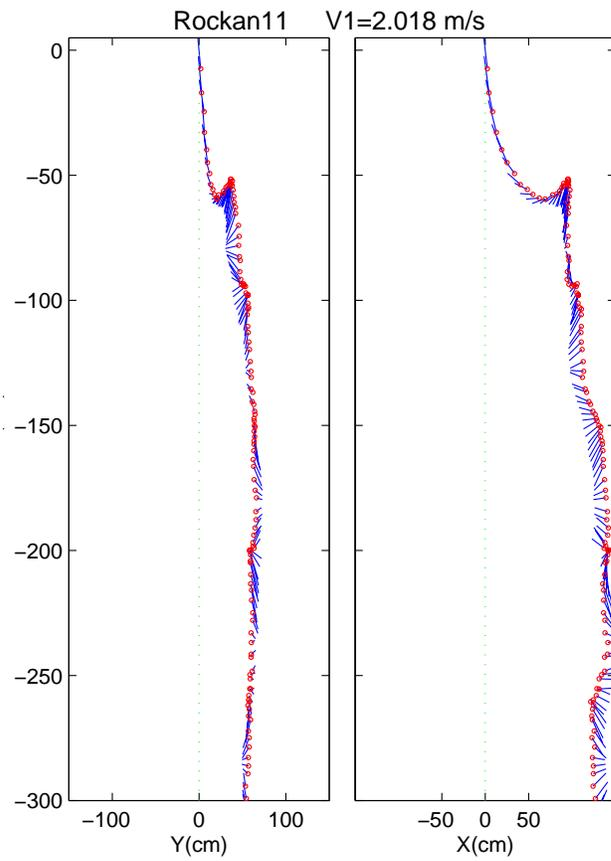

Rockan Drop 12

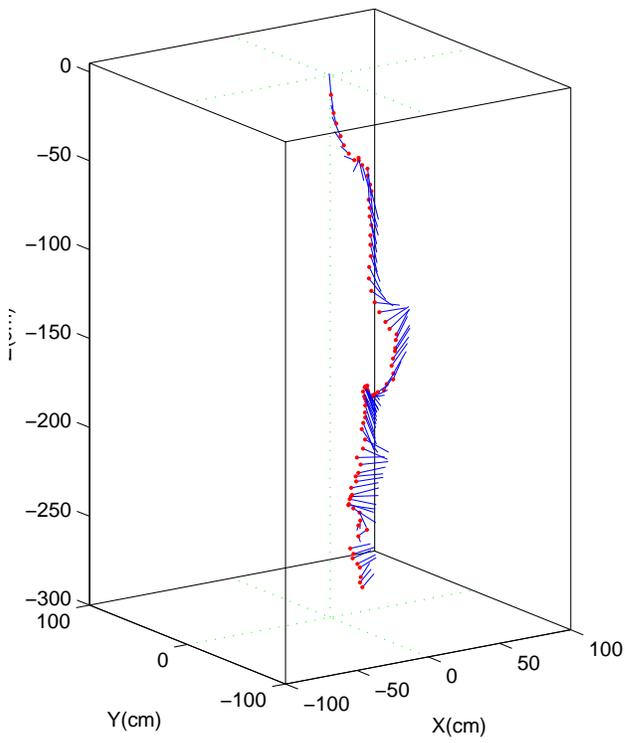
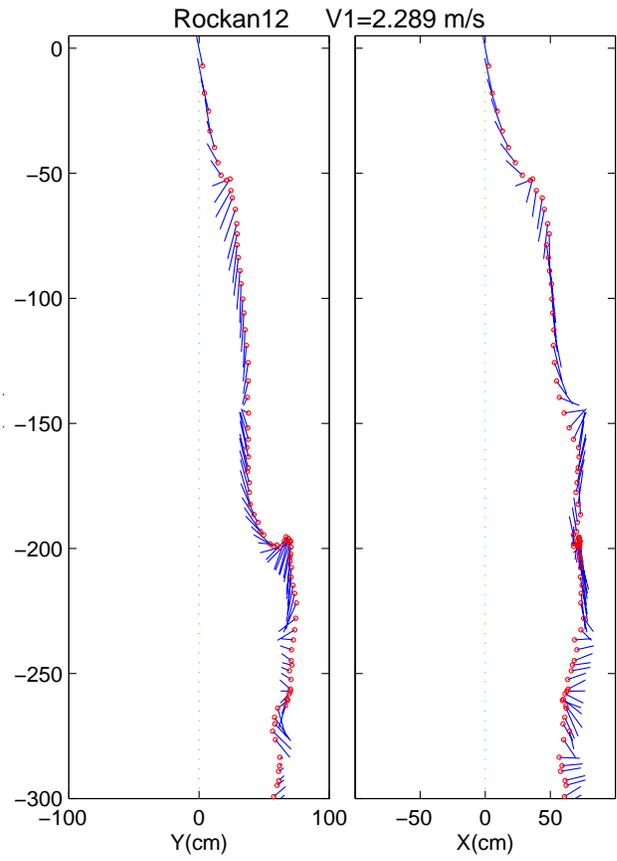

Rockan Drop 13

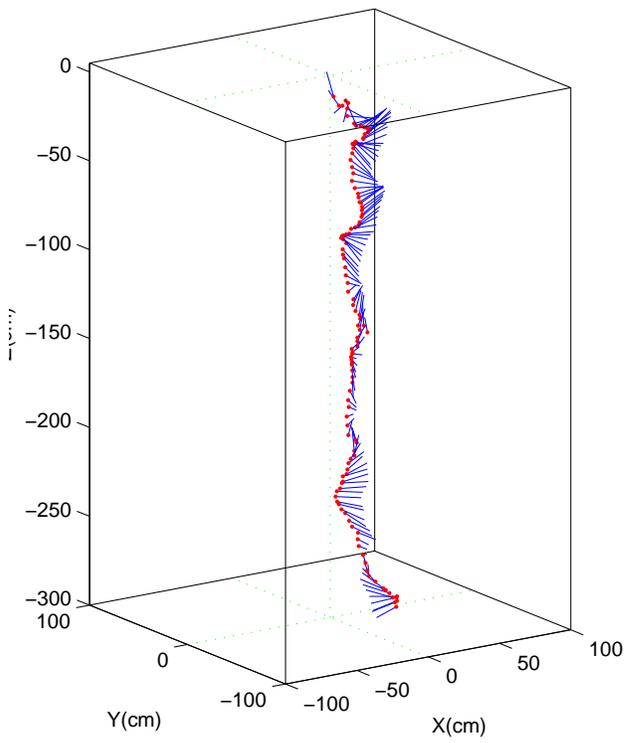
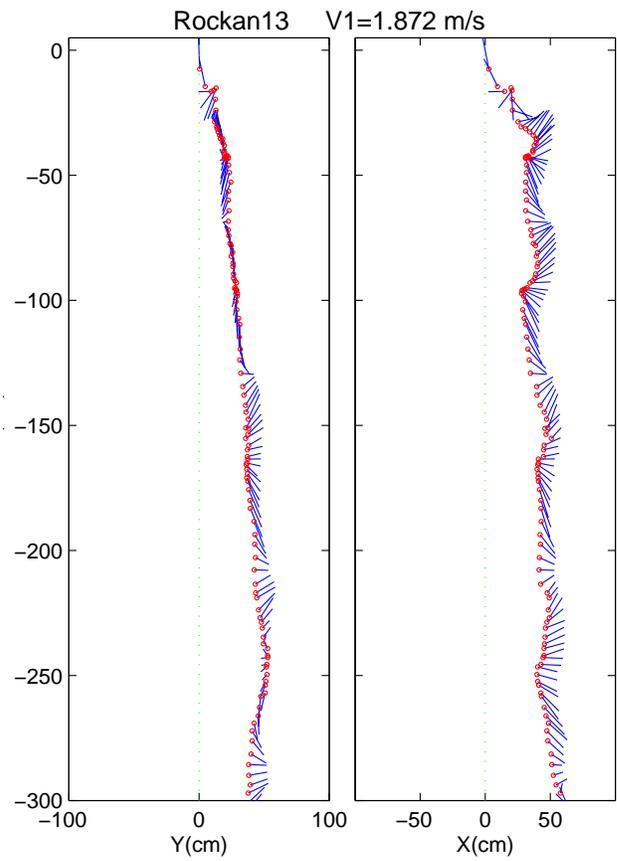

Rockan Drop 14

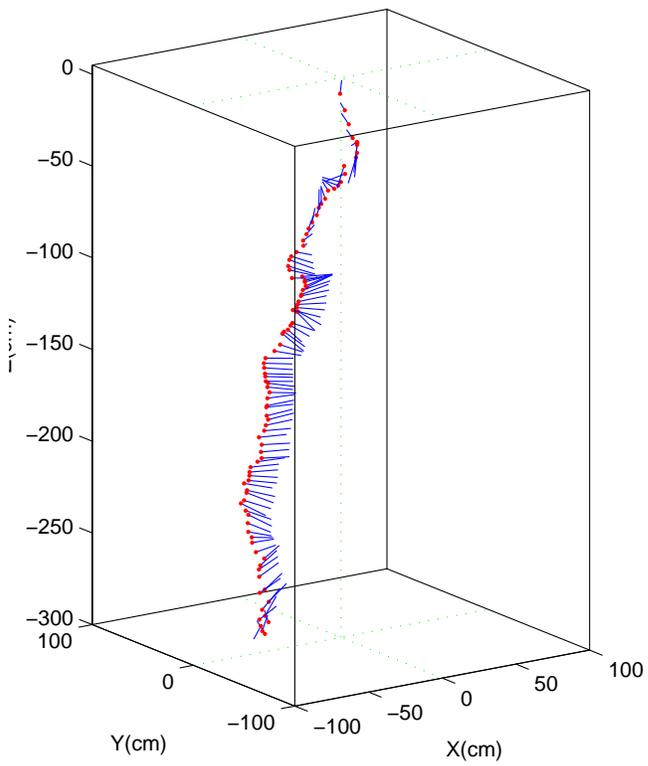
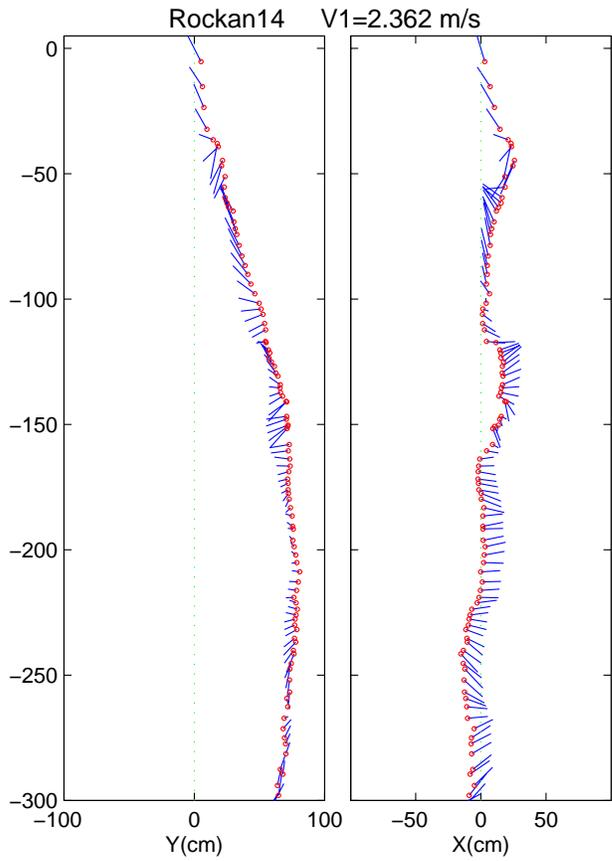

THIS PAGE INTENTIONALLY LEFT BLANK

APPENDIX B. FINAL POSITIONS

Appendix B contains the final position plots at a depth of 250 cm (scaled depth of 15 m) of the four mine shapes. The scales are in centimeters. The (0,0) position is based on the calibration cross.

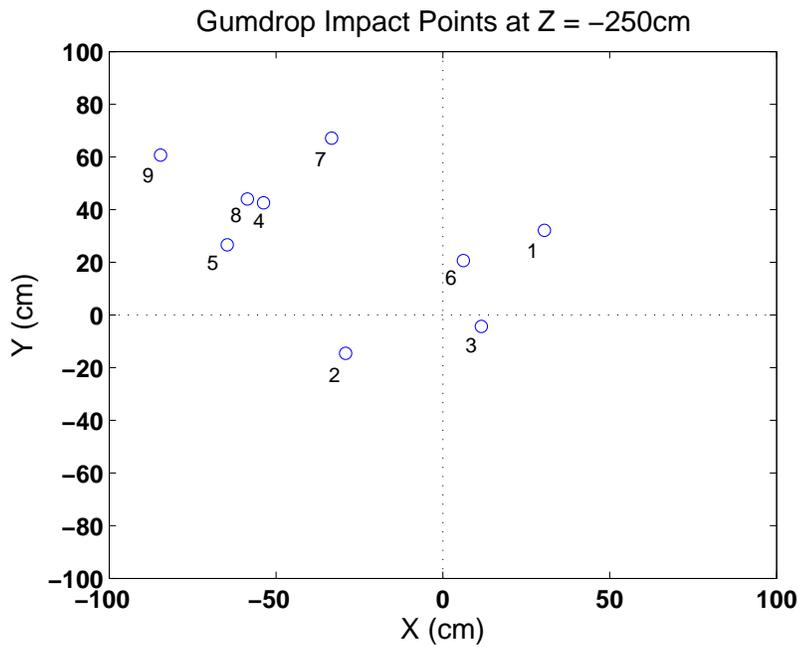
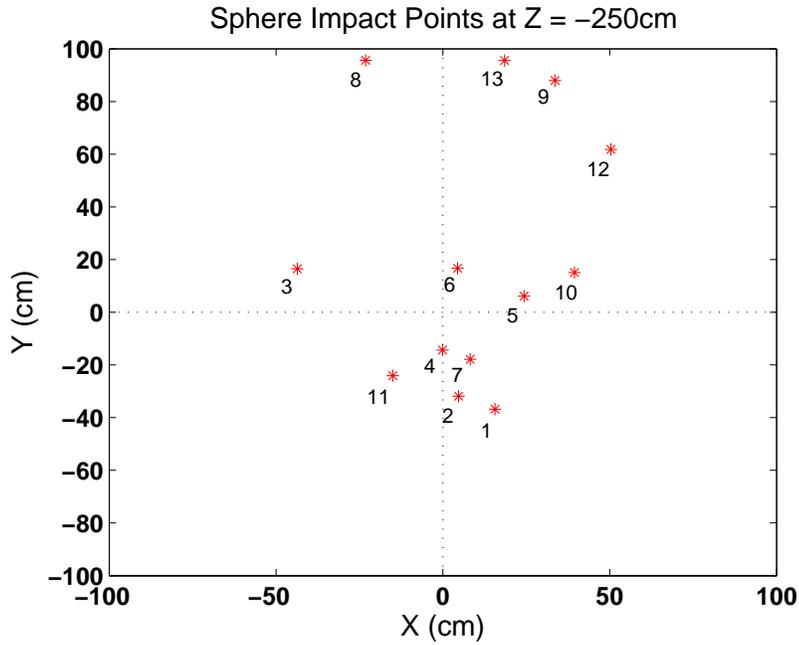

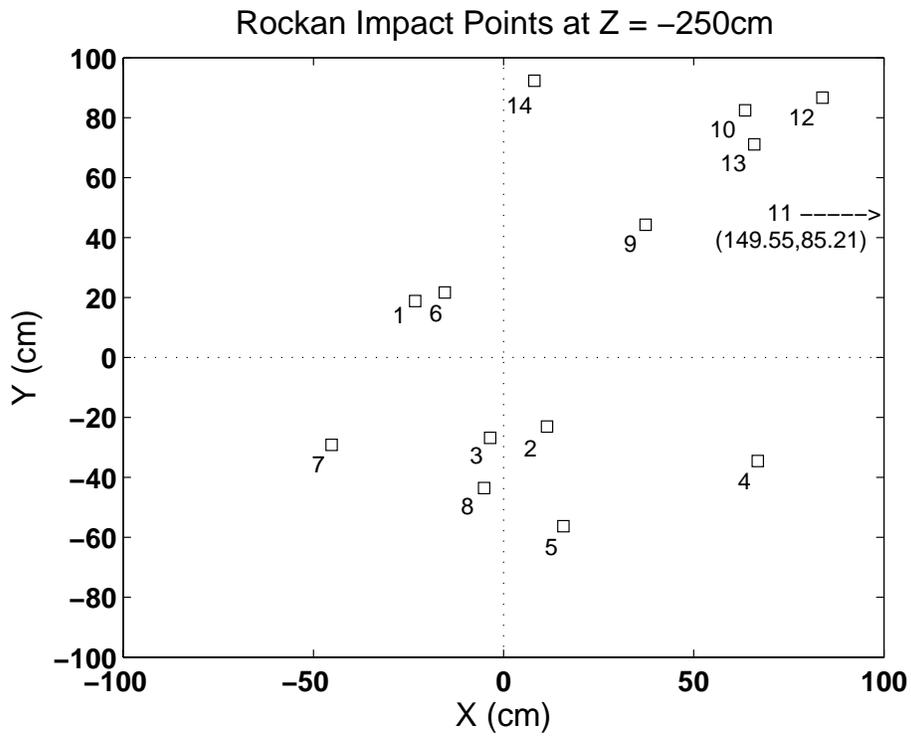
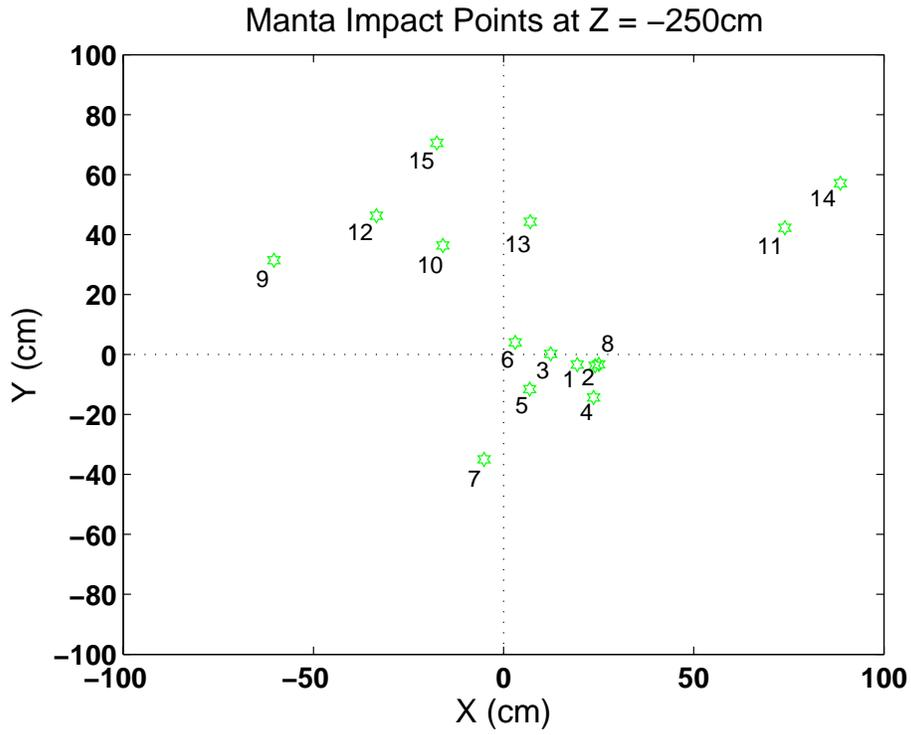

APPENDIX C. NUMERICAL DATA

Appendix C contains all of the numerical data points used in the mine shape trajectory graphs. Initial velocities (“v1”) are in m/s and are considered down (-z).

Sphere 1	v1= 3.209		
time	pos(x)	pos(y)	pos(z)
0	0	0	0
0.016	0.8038	0.5023	-4.3484
0.032	1.9279	0.0483	-10.2687
0.048	2.2536	0.3175	-14.0348
0.064	2.9779	0.3547	-19.1638
0.08	3.6583	0.2993	-22.9247
0.096	3.2841	0.0527	-27.8441
0.112	3.4405	-0.0403	-30.7666
0.128	4.0828	-0.0002	-34.5457
0.144	3.8981	-0.245	-38.1041
0.16	4.1787	-0.2064	-41.104
0.176	4.3464	-0.6344	-44.124
0.192	4.2983	-0.6299	-47.2329
0.208	3.6085	-1.0546	-50.0429
0.224	3.2636	-1.1257	-52.7767
0.24	2.7098	-1.6881	-56.4555
0.256	3.014	-1.8837	-59.2006
0.272	2.7923	-2.2608	-61.4414
0.288	2.2398	-2.1922	-63.8907
0.304	1.882	-2.7475	-67.0285
0.32	1.7334	-3.4196	-69.6419
0.336	1.4399	-3.6279	-72.1598
0.352	1.4189	-3.8456	-74.7194
0.368	0.8823	-4.4134	-77.3002
0.384	0.7467	-5.5408	-80.4371
0.4	0.0765	-5.1659	-82.7063
0.416	0.2399	-5.7156	-84.8442
0.432	-0.0727	-5.923	-86.3451
0.448	-0.284	-6.6144	-89.1216
0.464	-0.839	-7.2676	-91.3247
0.48	-0.5218	-8.1516	-93.3516
0.496	-0.7246	-9.7096	-95.7782
0.512	-1.5075	-10.3796	-97.2196
0.528	-1.2062	-11.1934	-99.9177
0.544	-1.6324	-12.6028	-101.925
0.56	-1.8848	-12.4397	-102.663
0.576	-1.7584	-13.7426	-104.623

Sphere
1 Cont.

time	pos(x)	pos(y)	pos(z)
0.592	-2.6411	-14.2707	-105.869
0.608	-2.5102	-15.0975	-107.074
0.624	-2.925	-16.0458	-108.93
0.64	-3.1514	-17.0746	-111.1
0.656	-3.178	-17.9261	-112.495
0.672	-3.4222	-18.9404	-114.349
0.688	-3.7076	-19.6855	-115.209
0.704	-3.8197	-20.4876	-116.608
0.72	-4.4617	-20.8652	-117.522
0.736	-4.1747	-21.906	-119.435
0.752	-4.0441	-22.0372	-120.172
0.768	-4.4996	-23.3995	-122.195
0.784	-4.6584	-24.1434	-124.331
0.8	-4.4225	-24.9456	-125.297
0.816	-4.6987	-25.5727	-126.42
0.832	-5.1594	-26.6962	-127.892
0.848	-4.9576	-28.1721	-129.734
0.864	-5.13	-28.8461	-130.821
0.88	-5.0852	-29.6513	-132.483
0.896	-4.9485	-31.0279	-134.606
0.912	-5.1604	-31.5633	-135.526
0.928	-5.075	-32.5517	-136.803
0.944	-5.4355	-33.4985	-138.469
0.96	-5.0868	-34.9077	-140.158
0.976	-5.1001	-35.798	-141.47
0.992	-5.0605	-36.0946	-142.674
1.008	-5.1617	-37.148	-144.215
1.024	-5.3745	-38.1128	-145.775
1.04	-5.3407	-39.4527	-147.035
1.056	-5.1303	-40.5973	-148.367
1.072	-4.8031	-41.766	-149.839
1.088	-4.5227	-42.533	-151.003
1.104	-4.6227	-43.3348	-152.691
1.12	-4.7559	-44.5085	-154.31
1.136	-4.2741	-45.6401	-155.609
1.152	-3.9633	-46.8618	-157.075
1.168	-3.8203	-48.4335	-158.387
1.184	-3.7184	-49.4796	-159.395
1.2	-3.5241	-50.4782	-160.961
1.216	-3.0523	-51.1299	-162.131
1.232	-3.0287	-52.2278	-163.232
1.248	-2.9212	-53.1273	-164.951
1.264	-2.7943	-54.4714	-166.49
1.28	-2.4776	-54.7678	-166.988

Sphere
1 Cont.

time	pos(x)	pos(y)	pos(z)
1.296	-2.2479	-55.7387	-168.347
1.312	-2.1228	-56.303	-169.362
1.328	-1.8559	-57.0612	-170.395
1.344	-1.1777	-58.3174	-171.907
1.36	-0.614	-59.187	-173.322
1.376	-0.5639	-60.031	-175.09
1.392	-0.0599	-60.5499	-175.717
1.408	0.0747	-61.0445	-176.54
1.424	0.385	-61.9881	-177.955
1.44	0.5739	-62.1736	-179.201
1.456	0.8458	-63.2274	-180.289
1.472	0.9978	-64.098	-181.626
1.488	0.9076	-63.7912	-182.506
1.504	1.3134	-64.6497	-183.716
1.52	1.6116	-65.0835	-184.727
1.536	1.9481	-65.5421	-185.999
1.552	2.0726	-65.9366	-186.884
1.568	2.2522	-65.615	-187.791
1.584	2.2633	-65.7537	-189.37
1.6	2.6149	-65.2173	-191.076
1.616	2.7623	-65.7541	-191.344
1.632	3.2054	-65.4093	-192.272
1.648	3.6359	-65.2158	-193.352
1.664	3.6384	-65.8605	-193.982
1.68	3.8693	-65.2392	-195.264
1.696	4.284	-65.1366	-196.675
1.712	4.4451	-65.0195	-197.755
1.728	4.9314	-64.5717	-198.95
1.744	5.2176	-64.0763	-200.07
1.76	5.4236	-63.7678	-201.038
1.776	5.9906	-63.0642	-202.596
1.792	6.3732	-63.2531	-203.659
1.808	6.9377	-61.4707	-205.398
1.824	7.2662	-61.5131	-206.248
1.84	7.573	-61.1638	-207.3
1.856	7.5996	-60.6597	-208.781
1.872	8.079	-59.4177	-210.321
1.888	8.4475	-58.832	-212.222
1.904	8.7214	-58.4438	-213.318
1.92	9.1508	-57.5169	-214.738
1.936	9.7076	-57.05	-216.429
1.952	10.032	-56.0891	-217.852
1.968	10.7926	-54.9628	-219.171
1.984	10.9859	-54.1597	-221.163

Sphere
1 Cont

time	pos(x)	pos(y)	pos(z)
2	11.4144	-53.4277	-222.527
2.016	11.6074	-52.6557	-224.367
2.032	11.6542	-52.2089	-225.173
2.048	12.4725	-50.2519	-227.857
2.064	12.4579	-50.5158	-228.1
2.08	12.5428	-49.5635	-230.239
2.096	13.2355	-48.2205	-231.687
2.112	13.199	-47.6416	-233.228
2.128	14.0635	-45.7523	-235.719
2.144	14.0123	-44.9512	-237.015
2.16	14.1667	-44.6676	-238.524
2.176	14.4525	-43.3133	-240.811
2.192	14.7275	-42.7418	-241.952
2.208	15.1532	-41.4992	-243.74
2.224	15.2721	-41.0208	-245.339
2.24	15.3646	-40.2708	-247.48
2.256	15.6193	-39.4315	-249.038
2.272	15.3741	-39.2872	-249.566
2.288	15.9905	-37.5722	-252.347
2.304	15.7614	-37.8619	-253.163
2.32	16.5216	-35.8268	-255.893
2.336	17.1508	-34.7157	-258.396
2.352	17.1157	-34.5436	-259.078
2.368	17.2807	-33.0881	-262.075
2.384	17.449	-31.9065	-264.251
2.4	17.1393	-31.8893	-265.864
2.416	17.7756	-30.7598	-267.613
2.432	17.5111	-31.0624	-268.855
2.448	16.8837	-30.6181	-271.696
2.464	17.2891	-29.5388	-274.079
2.48	17.363	-29.3085	-275.312

Sphere 2 v1= 3.893

time	pos(x)	pos(y)	pos(z)
0	0	0	0
0.016	-0.0626	-1.3154	-7.6158
0.032	-0.0128	-1.8173	-12.4577
0.048	0.5708	-2.4966	-18.1792
0.064	0.8041	-2.2419	-21.5722
0.08	0.6865	-1.7041	-25.2357
0.096	0.179	-2.6027	-30.4349
0.112	0.5199	-2.2552	-33.5328
0.128	0.5694	-2.8424	-37.5177
0.144	1.2083	-3.1461	-40.5024

Sphere
2 Cont

time	pos(x)	pos(y)	pos(z)
0.16	0.963	-3.6368	-43.7966
0.176	1.177	-3.2107	-46.781
0.192	0.5828	-3.3174	-49.2588
0.208	0.7868	-3.4133	-51.7028
0.224	0.9257	-3.1871	-54.8059
0.24	0.5718	-3.9547	-58.3781
0.256	1.5507	-4.0581	-61.4819
0.272	1.325	-4.3227	-63.9217
0.288	1.2437	-4.8341	-66.6328
0.304	1.727	-4.9892	-69.5777
0.32	2.3669	-5.5304	-71.8997
0.336	2.7865	-5.7457	-74.5682
0.352	2.8548	-7.5137	-78.6081
0.368	3.662	-8.0882	-80.667
0.384	4.8103	-9.5172	-83.6562
0.4	4.9202	-9.463	-84.4413
0.416	5.084	-10.3324	-87.8741
0.432	5.483	-11.0478	-89.9425
0.448	5.7234	-11.5833	-92.2159
0.464	6.3901	-12.1754	-93.588
0.48	6.4897	-12.5768	-95.7485
0.496	7.4168	-13.3392	-97.7528
0.512	8.0319	-14.0536	-99.5482
0.528	8.5129	-15.2763	-101.86
0.544	8.4541	-16.3267	-103.704
0.56	9.1684	-16.9946	-105.653
0.576	9.8641	-18.0695	-106.911
0.592	10.1972	-18.9017	-108.913
0.608	10.8715	-19.7173	-110.105
0.624	11.7954	-20.5273	-111.815
0.64	11.9508	-21.5968	-114.112
0.656	12.3436	-22.1765	-115.331
0.672	12.7453	-23.6713	-117.974
0.688	12.9524	-24.5175	-119.088
0.704	13.4132	-25.919	-120.741
0.72	13.7514	-26.3188	-121.686
0.736	13.9225	-27.7446	-123.775
0.752	14.6766	-28.4421	-125.47
0.768	15.0545	-29.6284	-126.989
0.784	15.2896	-30.2535	-128.764
0.8	15.0132	-31.7774	-130.465
0.816	15.4345	-32.3116	-132.29
0.832	15.6101	-33.3914	-133.602
0.848	16.5271	-34.9458	-135.982

Sphere
2 Cont

time	pos(x)	pos(y)	pos(z)
0.864	16.9623	-36.0445	-137.408
0.88	17.2969	-37.119	-138.897
0.896	17.659	-38.6132	-141.002
0.912	17.9463	-39.2118	-142.457
0.928	18.403	-40.6683	-144.401
0.944	18.6248	-41.2962	-145.599
0.96	18.3266	-41.8147	-147.191
0.976	19.0751	-42.4588	-149.303
0.992	19.1662	-43.3461	-150.95
1.008	19.4068	-44.122	-153.21
1.024	19.4501	-45.1396	-154.717
1.04	19.591	-45.8318	-156.915
1.056	19.8512	-46.6199	-158.976
1.072	20.1236	-47.2432	-160.401
1.088	20.2825	-47.6344	-162.207
1.104	20.6231	-48.0528	-164.392
1.12	20.6316	-48.6794	-166.123
1.136	20.8418	-48.3282	-167.882
1.152	20.6893	-48.8943	-169.587
1.168	20.6385	-48.8865	-170.668
1.184	20.7147	-49.1779	-172.751
1.2	21.0274	-49.4513	-174.424
1.216	20.2984	-49.1392	-175.981
1.232	20.4112	-49.1111	-177.289
1.248	20.1675	-48.3137	-178.96
1.264	20.84	-48.0404	-180.669
1.28	20.2434	-47.6991	-182.533
1.296	20.4836	-46.9211	-184.12
1.312	20.4954	-46.4307	-185.606
1.328	20.4456	-46.2512	-187.134
1.344	20.4826	-46.0856	-188.986
1.36	20.4038	-45.5129	-190.495
1.376	20.145	-45.4255	-192.1
1.392	20.2	-43.9417	-193.875
1.408	20.1678	-43.5287	-195.076
1.424	20.0158	-43.234	-196.878
1.44	19.5799	-41.9627	-198.963
1.456	19.2179	-40.8868	-200.666
1.472	19.4413	-40.6108	-202.676
1.488	19.6401	-39.818	-204.031
1.504	19.5352	-39.0311	-205.311
1.52	19.1029	-38.8091	-208.014
1.536	19.0213	-38.4795	-209.941
1.552	18.5791	-37.4462	-211.859

Sphere
2 Cont

time	pos(x)	pos(y)	pos(z)
1.568	18.5964	-37.1002	-213.275
1.584	18.6349	-36.6497	-215.226
1.6	18.4934	-35.6988	-217.531
1.616	18.0401	-35.2409	-219.675
1.632	17.8946	-35.2434	-221.315
1.648	17.7233	-34.6812	-223.439
1.664	17.3327	-34.5576	-224.654
1.68	16.9272	-34.0452	-226.78
1.696	17.0128	-34.0295	-228.649
1.712	16.4262	-33.3564	-231.676
1.728	16.4073	-33.081	-233.335
1.744	17.0842	-33.2908	-234.331
1.76	17.1156	-33.1512	-237.415
1.776	16.826	-33.4903	-238.664
1.792	16.5886	-32.9387	-240.482
1.808	16.6287	-32.9594	-242.955
1.824	16.5765	-32.9491	-244.616
1.84	16.5307	-33.0799	-246.433
1.856	16.7843	-33.1894	-248.509
1.872	16.8595	-32.8797	-251.128
1.888	16.8726	-32.6541	-252.245
1.904	17.3162	-32.6747	-253.986
1.92	17.4101	-32.9371	-256.123
1.936	17.4546	-33.0424	-257.809
1.952	17.9381	-32.6689	-259.651
1.968	17.9354	-32.8127	-261.804
1.984	18.4272	-33.4624	-263.507
2	18.6587	-33.1725	-265.328
2.016	19.1243	-33.0961	-267.941
2.032	19.5829	-32.419	-269.643

Sphere 3 v1= 4.050

time	pos(x)	pos(y)	pos(z)
0	0	0	0
0.016	0.2187	-1.8051	-8.9072
0.032	0.8241	-1.841	-12.9617
0.048	1.1814	-2.3061	-18.1832
0.064	0.1601	-1.4043	-22.3002
0.08	0.56	-1.9009	-26.6241
0.096	0.9614	-1.8841	-30.8366
0.112	0.8896	-1.4202	-34.4308
0.128	-0.2249	-1.3656	-38.6023
0.144	1.3991	-1.2818	-41.8273
0.16	1.0016	-0.9605	-44.8921

Sphere
3 Cont

time	pos(x)	pos(y)	pos(z)
0.176	0.6053	-1.9521	-48.9555
0.192	1.1158	-1.1224	-51.2433
0.208	1.1373	-1.4554	-54.8258
0.224	1.2285	-0.8362	-57.4837
0.24	1.7034	-1.5143	-60.9765
0.256	1.5568	-0.6038	-63.4619
0.272	0.852	-0.5486	-66.6159
0.288	1.4333	-0.9517	-69.476
0.304	1.7312	-0.7651	-73.3456
0.32	1.564	-0.5772	-75.4616
0.336	1.6365	-0.7768	-78.2821
0.352	1.9924	-0.2694	-81.5221
0.368	1.7287	0.1983	-83.967
0.384	1.8797	0.2738	-87.0137
0.4	1.9323	0.507	-89.7261
0.416	2.1971	0.7101	-92.1078
0.432	2.2317	1.3972	-94.3274
0.448	2.2405	1.5888	-96.0789
0.464	2.1724	2.451	-98.8204
0.48	2.8868	3.1868	-100.925
0.496	2.871	3.8633	-102.78
0.512	1.9263	5.0688	-104.887
0.528	2.2615	6.0462	-106.576
0.544	2.5075	7.1819	-107.947
0.56	2.0703	7.9103	-110.244
0.576	2.2906	8.5122	-112.322
0.592	1.7403	9.4286	-114.705
0.608	1.546	10.2693	-116.533
0.624	1.4641	11.0738	-118.317
0.64	1.3727	11.5564	-120.035
0.656	1.2103	13.2842	-122.369
0.672	0.9228	14.2245	-123.874
0.688	0.2636	14.886	-126.448
0.704	-0.3105	16.0915	-128.234
0.72	-0.7257	16.5257	-130.876
0.736	-0.4534	17.4108	-132.52
0.752	-0.7479	18.4212	-134.489
0.768	-2.1918	19.1259	-137.414
0.784	-3.5922	19.7631	-139.201
0.8	-3.2894	20.9508	-141.739
0.816	-3.4031	21.3455	-143.48
0.832	-3.9181	21.8264	-146.177
0.848	-5.425	22.8831	-148.372
0.864	-6.2198	23.4072	-150.922

Sphere
3 Cont

time	pos(x)	pos(y)	pos(z)
0.88	-6.3682	24.1851	-152.949
0.896	-7.9425	24.9168	-154.835
0.912	-8.4203	24.9886	-156.913
0.928	-8.9046	24.979	-160.085
0.944	-10.4477	25.4382	-162.773
0.96	-11.4852	25.9864	-164.816
0.976	-12.2665	26.1646	-166.894
0.992	-14.3044	26.8138	-169.186
1.008	-15.2535	26.617	-172.462
1.024	-15.8595	27.0668	-174.989
1.04	-16.8779	27.3042	-176.591
1.056	-18.6843	27.7597	-178.773
1.072	-19.8787	27.6011	-182.287
1.088	-20.9345	27.8754	-185.143
1.104	-22.4428	28.051	-186.941
1.12	-23.5415	27.589	-188.7
1.136	-25.6002	28.0107	-191.018
1.152	-26.5722	28.0007	-193.273
1.168	-27.4501	27.6543	-195.009
1.184	-29.9179	28.4319	-198.298
1.2	-29.4483	27.6967	-201.73
1.216	-29.8132	27.3336	-203.4
1.232	-29.8347	26.6605	-206.488
1.248	-30.7412	26.5319	-208.292
1.264	-32.6533	25.8608	-210.49
1.28	-33.4063	25.9961	-213.422
1.296	-34.1931	25.4581	-215.444
1.312	-34.5677	24.5188	-218.217
1.328	-35.2696	23.9108	-220.713
1.344	-34.6266	22.2066	-222.897
1.36	-34.9272	21.2522	-225.311
1.376	-35.5511	21.0489	-228.036
1.392	-35.4639	20.8553	-229.993
1.408	-35.7323	19.8055	-232.662
1.424	-35.9772	19.9128	-235.561
1.44	-35.6645	18.4612	-237.535
1.456	-35.9522	17.6119	-239.558
1.472	-36.0825	16.8415	-242.013
1.488	-35.8052	16.1322	-244.663
1.504	-35.1601	15.6387	-247.252
1.52	-36.7261	16.2556	-249.845
1.536	-35.3356	14.6852	-252.126
1.552	-34.6374	13.4483	-254.235
1.568	-34.3852	13.4876	-257.183

Sphere
3 Cont

time	pos(x)	pos(y)	pos(z)
1.584	-34.3836	13.3699	-259.853
1.6	-34.0498	12.0574	-261.942
1.616	-33.915	11.7363	-263.343
1.632	-33.7227	12.1045	-266.825
1.648	-32.0202	10.9393	-270.402
1.664	-31.6487	9.8337	-271.586
1.68	-30.114	9.9538	-273.549
1.696	-30.0811	8.8666	-275.899
1.712	-29.3307	8.4795	-278.732
1.728	-27.7446	7.6763	-280.065
1.744	-27.993	8.268	-283.139
1.76	-25.8795	7.3917	-284.941

Sphere 4 v1= 2.785

time	pos(x)	pos(y)	pos(z)
0	0	0	0
0.016	-0.9479	0.7108	-4.5053
0.032	-0.424	1.0034	-8.9133
0.048	0.506	0.2933	-14.8885
0.064	0.7246	-0.6834	-22.0999
0.08	0.5241	-0.1989	-24.4609
0.096	0.7057	-0.2979	-27.9789
0.112	0.8665	0.0536	-31.475
0.128	0.5413	-0.7057	-36.4657
0.144	0.7006	-1.3062	-40.0366
0.16	0.6432	-0.8372	-42.5063
0.176	0.4232	-1.3195	-45.9077
0.192	0.4855	-0.1882	-47.5376
0.208	1.4806	-0.7105	-50.7518
0.224	1.4632	-1.1452	-53.314
0.24	0.855	-0.6458	-55.1042
0.256	1.2194	-0.6989	-58.8218
0.272	1.8815	-1.0988	-61.4586
0.288	1.6781	-1.1903	-64.0382
0.304	1.632	-1.4988	-66.5811
0.32	1.7051	-0.9491	-68.1445
0.336	1.457	-0.7157	-70.9242
0.352	1.6394	-1.694	-74.1945
0.368	1.935	-2.1982	-77.0239
0.384	2.9375	-2.7205	-79.0058
0.4	2.007	-2.9508	-81.2408
0.416	2.24	-4.0878	-83.2974
0.432	3.0358	-4.4719	-85.6884
0.448	2.3724	-5.2945	-87.8457

Sphere
4 Cont

time	pos(x)	pos(y)	pos(z)
0.464	2.6932	-5.3182	-88.9876
0.48	2.8857	-6.0463	-90.5975
0.496	2.8253	-6.429	-91.9674
0.512	3.3671	-7.095	-93.3852
0.528	3.1031	-7.0884	-94.4291
0.544	3.2023	-8.0347	-96.3371
0.56	3.968	-8.4645	-97.9127
0.576	4.1707	-9.785	-99.6248
0.592	4.0669	-9.9448	-100.211
0.608	3.7942	-10.252	-101.649
0.624	3.6371	-10.3578	-102.621
0.64	3.505	-10.7457	-103.83
0.656	4.2588	-11.6973	-105.617
0.672	4.184	-12.2615	-107.537
0.688	3.5208	-12.2704	-107.804
0.704	3.7215	-12.7182	-109.969
0.72	3.7543	-12.6128	-110.624
0.736	3.7372	-12.8098	-111.771
0.752	3.7669	-13.7017	-113.425
0.768	3.8899	-13.4402	-114.197
0.784	3.7733	-14.3212	-115.83
0.8	4.0973	-14.6909	-117.584
0.816	4.0525	-15.4672	-117.992
0.832	4.1386	-15.9655	-119.778
0.848	4.1437	-16.5879	-121.241
0.864	4.124	-16.9181	-122.946
0.88	4.1774	-17.6734	-124.116
0.896	4.2946	-18.3002	-125.574
0.912	4.3366	-18.3989	-126.723
0.928	4.6502	-18.959	-128.259
0.944	4.9618	-19.6839	-130.005
0.96	4.8277	-19.8329	-131.241
0.976	5.1546	-20.6863	-133.137
0.992	5.1707	-21.7076	-135.125
1.008	5.4423	-22.1004	-136.417
1.024	5.3284	-22.5144	-138.126
1.04	5.675	-23.269	-139.823
1.056	5.8034	-23.6016	-141.209
1.072	5.4483	-23.9234	-142.776
1.088	5.3317	-24.6205	-144.431
1.104	5.2608	-24.3307	-146.078
1.12	5.1556	-24.768	-147.697
1.136	5.2619	-24.6455	-148.636
1.152	5.1694	-24.3844	-150.171

Sphere
4 Cont

time	pos(x)	pos(y)	pos(z)
1.168	5.5883	-24.9722	-151.624
1.184	4.7785	-24.6986	-153.704
1.2	4.9286	-24.3996	-154.988
1.216	4.8182	-24.346	-156.445
1.232	5.098	-24.9695	-157.882
1.248	5.2696	-24.9581	-160.101
1.264	5.1598	-25.2087	-161.212
1.28	4.8992	-24.5509	-162.787
1.296	5.041	-24.6488	-164.012
1.312	4.6742	-25.0175	-165.819
1.328	4.2712	-24.3084	-166.728
1.344	4.4003	-23.7566	-168.357
1.36	4.1365	-23.4472	-170.15
1.376	4.0222	-23.4022	-171.536
1.392	3.7163	-22.6056	-172.447
1.408	3.2932	-22.0628	-174.183
1.424	3.1388	-21.6947	-175.614
1.44	2.573	-21.2894	-177.48
1.456	2.5898	-21.5146	-178.731
1.472	2.3107	-21.4646	-180.328
1.488	1.8943	-21.3992	-181.342
1.504	1.2786	-20.6037	-183.655
1.52	1.0616	-19.6728	-184.81
1.536	0.4798	-19.5537	-186.728
1.552	0.1091	-18.737	-188.896
1.568	-0.4143	-17.8898	-190.581
1.584	-0.3148	-17.4043	-191.936
1.6	-0.3201	-17.4009	-193.309
1.616	-0.4441	-17.7136	-194.691
1.632	-0.8459	-16.9525	-197.253
1.648	-1.0583	-16.3824	-199.085
1.664	-1.5172	-16.2967	-200.383
1.68	-1.8018	-16.2716	-202.604
1.696	-1.6973	-15.8276	-204.535
1.712	-1.2476	-15.9014	-206.025
1.728	-1.5321	-14.9839	-208.986
1.744	-1.178	-15.6737	-210.418
1.76	-1.7289	-14.8378	-211.987
1.776	-1.7848	-14.4347	-213.678
1.792	-2.2563	-14.3635	-215.556
1.808	-2.3517	-13.6167	-217.511
1.824	-1.7196	-14.197	-219.36
1.84	-0.9521	-14.1899	-221.228
1.856	-0.6267	-14.9	-223.058

Sphere
4 Cont

time	pos(x)	pos(y)	pos(z)
1.872	-0.9877	-14.2204	-225.169
1.888	-0.5102	-14.7073	-227.052
1.904	-0.2928	-13.4521	-228.357
1.92	-0.4938	-13.7541	-231.181
1.936	0.4266	-13.7165	-232.916
1.952	0.871	-13.6929	-234.308
1.968	0.5748	-14.1681	-235.961
1.984	1.0273	-14.3183	-237.564
2	2.1956	-13.6391	-240.018
2.016	2.7249	-14.297	-241.817
2.032	3.1686	-14.5563	-243.118
2.048	4.1665	-13.9795	-245.425
2.064	4.5011	-14.7961	-246.541
2.08	4.9558	-14.6719	-248.32
2.096	6.1977	-14.569	-249.53
2.112	6.7133	-14.4391	-251.997
2.128	7.0255	-14.8956	-252.694
2.144	7.7635	-14.5937	-255.152
2.16	7.6013	-14.9215	-256.643
2.176	9.0413	-14.9443	-258.916
2.192	9.9306	-14.8022	-261.134
2.208	10.2145	-15.4329	-262.264
2.224	10.6194	-15.5335	-264.09
2.24	11.7254	-15.5391	-265.505
2.256	11.9796	-15.282	-267.554
2.272	13.3291	-16.558	-268.198
2.288	13.0052	-15.7286	-271.193
2.304	13.222	-15.1844	-273.952
2.32	13.33	-15.8565	-274.361
2.336	14.6724	-15.9618	-276.232

Sphere 5 v1= 3.191

time	pos(x)	pos(y)	pos(z)
0	0	0	0
0.016	-0.4673	0.3452	-5.0528
0.032	0.4172	0.0521	-10.2102
0.048	0.6257	-0.2998	-15.3117
0.064	0.9586	-0.2026	-20.0164
0.08	1.3895	-0.0326	-23.2997
0.096	1.4915	-0.0019	-27.5638
0.112	1.3572	-0.4337	-31.0186
0.128	2.0466	-0.4466	-34.9304
0.144	2.0386	-0.4099	-37.6633
0.16	1.8273	-0.0429	-39.7903

Sphere
5 Cont

time	pos(x)	pos(y)	pos(z)
0.176	1.9279	-0.1333	-42.4557
0.192	2.3191	-0.1517	-46.0558
0.208	2.6051	-0.1966	-48.7014
0.224	1.9166	-0.3711	-51.0734
0.24	2.1714	-0.2619	-54.166
0.256	2.1751	-0.2843	-56.8982
0.272	2.8748	-0.4503	-60.014
0.288	3.0283	0.2244	-61.9481
0.304	3.3657	-0.082	-64.7997
0.32	2.6624	-0.3601	-67.2486
0.336	3.5351	-0.0828	-70.3738
0.352	4.221	0.0089	-72.1959
0.368	4.3202	-0.6609	-75.7114
0.384	4.9557	-0.2691	-77.2615
0.4	5.462	-0.0879	-79.3021
0.416	6.6136	0.0384	-81.8167
0.432	7.5103	-0.514	-84.1093
0.448	7.5173	0.0798	-86.1132
0.464	8.7188	-0.2369	-88.1813
0.48	8.554	-0.025	-89.2334
0.496	10.3503	-0.1501	-90.9619
0.512	10.8413	-0.1906	-93.3166
0.528	12.566	-0.1499	-94.8517
0.544	13.0738	-0.4378	-96.4368
0.56	14.0718	-0.9838	-97.7017
0.576	15.2643	-0.1357	-98.3323
0.592	15.5916	-0.2798	-100.202
0.608	17.1237	-0.3019	-100.95
0.624	18.0556	-0.1228	-101.526
0.64	18.3267	-0.6307	-102.834
0.656	19.0963	-0.4561	-104.584
0.672	19.8356	-0.5682	-105.473
0.688	20.2376	-0.2025	-106.494
0.704	20.9534	-0.2735	-107.628
0.72	21.6131	-0.2422	-108.605
0.736	22.394	0.0898	-109.665
0.752	22.2233	-0.0716	-110.28
0.768	23.2331	-0.0959	-112.195
0.784	24.1044	0.0605	-113.405
0.8	24.9091	-0.5327	-114.835
0.816	24.4164	-0.3836	-116.13
0.832	25.1544	-0.549	-117.403
0.848	25.7819	-0.7276	-119.095
0.864	26.1708	-0.511	-119.836

Sphere
5 Cont

time	pos(x)	pos(y)	pos(z)
0.88	26.0445	-0.4232	-121.085
0.896	26.7535	-0.6118	-122.539
0.912	27.9366	-0.5979	-124.347
0.928	27.583	-0.9018	-126.014
0.944	27.5587	-0.9859	-127.219
0.96	28.5453	-1.2507	-129.402
0.976	28.8422	-0.891	-130.311
0.992	29.0753	-0.7243	-132.184
1.008	29.2376	-0.9327	-133.632
1.024	29.3919	-0.9789	-135.374
1.04	29.5558	-1.211	-137.288
1.056	29.8684	-1.3351	-138.78
1.072	30.0874	-1.3188	-140.917
1.088	30.1087	-1.2397	-142.177
1.104	30.3639	-1.6513	-144.113
1.12	30.8187	-2.0079	-145.86
1.136	30.6601	-2.0518	-147.439
1.152	30.297	-2.1776	-149.304
1.168	30.1726	-1.957	-151.261
1.184	30.0394	-2.5161	-152.845
1.2	29.3869	-1.8829	-154.022
1.216	29.96	-2.5099	-156.188
1.232	29.0453	-2.6029	-158.643
1.248	29.2164	-2.6764	-159.771
1.264	29.0247	-2.809	-161.7
1.28	28.4322	-3.7779	-162.938
1.296	28.3003	-3.6265	-165.002
1.312	27.9828	-3.5807	-166.383
1.328	27.7391	-4.0051	-168.773
1.344	27.2935	-4.4392	-170.012
1.36	27.3814	-4.82	-171.526
1.376	26.8329	-4.9807	-173.525
1.392	26.3996	-5.3892	-175.277
1.408	26.4537	-5.2798	-177.431
1.424	25.8982	-5.4933	-178.802
1.44	25.9165	-5.485	-180.905
1.456	25.4848	-5.9351	-182.781
1.472	25.2548	-6.2456	-184.481
1.488	24.9008	-5.637	-185.906
1.504	24.3987	-6.4021	-187.972
1.52	23.3877	-5.6561	-189.749
1.536	23.3625	-5.8173	-191.23
1.552	22.9228	-5.5392	-193.285
1.568	23.1054	-5.5447	-195.721

Sphere
5 Cont

time	pos(x)	pos(y)	pos(z)
1.584	22.9875	-5.3695	-197.387
1.6	22.6025	-5.644	-199.325
1.616	22.2616	-4.72	-201.344
1.632	22.3082	-4.6238	-203.477
1.648	22.6499	-4.6684	-204.703
1.664	22.4673	-4.0295	-207.197
1.68	22.2513	-3.2696	-209.603
1.696	22.2988	-3.0524	-211.548
1.712	22.7247	-2.7113	-213.809
1.728	21.1032	-1.9579	-215.549
1.744	22.2557	-2.6772	-217.419
1.76	23.3638	-1.7093	-219.116
1.776	23.3815	-1.7363	-221.719
1.792	23.465	-1.36	-223.544
1.808	23.7557	0.0604	-225.107
1.824	23.5508	0.7564	-227.016
1.84	23.88	0.4913	-228.233
1.856	24.3159	1.5003	-230.52
1.872	23.578	1.6777	-232.169
1.888	24.5929	1.686	-234.626
1.904	24.8595	2.0461	-236.412
1.92	26.0723	2.3875	-238.19
1.936	26.219	1.976	-239.764
1.952	26.916	3.9871	-242.933
1.968	27.3332	4.0812	-244.068
1.984	28.3533	5.1883	-247.232
2	28.5189	5.6251	-249.401
2.016	29.2217	4.8228	-251.068
2.032	29.357	5.3412	-252.846
2.048	30.7507	5.985	-255.505
2.064	31.3343	5.6271	-256.497
2.08	31.5735	6.3483	-259.325
2.096	32.2339	6.7713	-261.226
2.112	32.5949	6.2979	-263.11
2.128	33.095	6.3055	-265.379
2.144	33.0835	7.0029	-267.835
2.16	33.7802	8.076	-269.923
2.176	34.5108	7.3783	-271.924
2.192	35.2393	8.3756	-273.378
2.208	35.3863	8.5814	-277.019
2.224	35.9445	8.6091	-279.651
2.24	36.5059	8.843	-281.015
2.256	36.8645	9.2562	-282.783
2.272	38.0483	9.2964	-285.328

Sphere
5 Cont

time	pos(x)	pos(y)	pos(z)
2.288	38.3419	9.3584	-287.477
2.304	38.0649	9.613	-289.952
2.32	38.7267	9.6992	-291.791
2.336	40.0444	9.9215	-293.898

Sphere 6 v1= 3.337

time	pos(x)	pos(y)	pos(z)
0	0	0	0
0.016	-0.6332	0.2607	-4.8893
0.032	-0.079	-0.4455	-10.6796
0.048	0.1744	-0.8972	-16.4749
0.064	-0.2911	-0.6375	-20.3091
0.08	0.5641	-0.6499	-24.8925
0.096	0.33	-0.5842	-28.9463
0.112	0.0217	-0.8466	-33.7224
0.128	0.2283	-0.9202	-37.3341
0.144	0.8411	-1.2485	-40.7105
0.16	0.2695	-0.8553	-43.0687
0.176	0.275	-0.4556	-45.9052
0.192	0.3002	-0.7326	-49.0772
0.208	0.7247	-0.92	-52.7299
0.224	0.7939	-0.846	-55.5489
0.24	0.7957	-1.1533	-59.3498
0.256	0.3821	-1.0198	-61.3418
0.272	-0.1463	-0.6008	-64.932
0.288	0.4056	-1.588	-68.5678
0.304	0.5128	-1.1268	-71.0961
0.32	0.7041	-1.5483	-74.3514
0.336	0.0183	-1.1656	-77.0363
0.352	-0.099	-1.1421	-79.8771
0.368	0.1585	-1.6101	-82.829
0.384	0.3903	-0.6929	-85.8663
0.4	0.4484	-1.2981	-88.6083
0.416	0.2421	-0.956	-91.0214
0.432	0.3075	-0.5702	-93.7308
0.448	0.153	-1.0864	-96.678
0.464	-0.2409	-0.0958	-99.1918
0.48	0.335	0.3083	-101.127
0.496	-0.2007	0.835	-103.63
0.512	-0.7142	0.9423	-105.871
0.528	-0.5771	1.68	-108.422
0.544	-0.8901	1.9121	-109.907
0.56	-1.5038	2.4508	-112.463
0.576	-1.3705	2.9245	-114.427

Sphere
6 Cont

time	pos(x)	pos(y)	pos(z)
0.592	-2.1018	3.5339	-116.542
0.608	-1.9601	4.6272	-118.338
0.624	-2.405	5.2521	-120.866
0.64	-2.6143	6.3999	-122.696
0.656	-3.198	7.0254	-124.986
0.672	-2.6796	8.2334	-126.762
0.688	-3.336	8.1156	-129.204
0.704	-3.5626	8.5214	-131.127
0.72	-3.8524	10.1875	-133.626
0.736	-3.538	11.2481	-135.836
0.752	-3.4353	12.5514	-137.743
0.768	-4.5018	13.3705	-139.734
0.784	-3.6914	13.5604	-142.492
0.8	-4.4435	14.3247	-144.48
0.816	-4.0952	15.583	-146.882
0.832	-4.3557	16.072	-148.627
0.848	-3.5538	16.143	-151.186
0.864	-3.6642	18.3086	-152.993
0.88	-3.4796	18.681	-155.205
0.896	-3.9718	19.2497	-157.925
0.912	-3.1512	19.4949	-160.538
0.928	-2.3498	20.8212	-162.824
0.944	-2.57	20.9841	-165.064
0.96	-1.0908	22.155	-168.014
0.976	-0.8605	22.2466	-170.804
0.992	0.2499	22.7706	-172.908
1.008	0.0147	23.1754	-175.814
1.024	0.6656	24.2025	-179.056
1.04	2.0479	24.6059	-180.921
1.056	2.975	24.9858	-184.041
1.072	3.2108	24.9452	-186.606
1.088	3.4508	25.1772	-189.745
1.104	4.1566	25.2093	-192.758
1.12	4.8688	25.3986	-195.366
1.136	6.0687	25.3954	-198.782
1.152	6.3194	25.4713	-200.539
1.168	7.2649	25.4362	-203.128
1.184	7.3002	25.2833	-206.746
1.2	6.1519	25.1829	-208.896
1.216	6.8348	24.3243	-211.394
1.232	7.8186	24.4523	-214.379
1.248	7.8352	23.9636	-217.81
1.264	7.3787	24.0664	-219.773
1.28	8.3125	23.386	-222.617

Sphere
6 Cont

time	pos(x)	pos(y)	pos(z)
1.296	8.1566	23.2253	-225.701
1.312	8.3378	21.9458	-227.899
1.328	7.939	21.7266	-230.721
1.344	8.4071	21.1137	-233.534
1.36	7.9408	19.9996	-235.584
1.376	8.1451	19.4511	-238.58
1.392	8.3387	18.2438	-240.346
1.408	7.2924	17.9322	-243.323
1.424	6.6455	18.0099	-245.617
1.44	5.9961	16.8722	-247.912
1.456	7.364	15.7873	-250.9
1.472	7.4025	15.1272	-253.503
1.488	6.7386	14.3335	-255.189
1.504	5.7508	13.0577	-257.046
1.52	5.7398	13.3492	-259.491
1.536	5.2195	12.0152	-262.649
1.552	3.3761	11.9259	-265.106
1.568	3.6148	10.4773	-266.891
1.584	4.0983	9.6559	-268.576
1.6	3.5921	9.3672	-271.749
1.616	3.6741	9.2837	-273.734
1.632	1.5041	7.977	-276.151
1.648	1.4636	8.1805	-278.79
1.664	1.2956	7.7209	-280.805
1.68	0.6736	7.5669	-283.398
1.696	-0.0397	7.0859	-285.931
1.712	-0.4947	6.9459	-288.284
1.728	-3.2521	7.3343	-291.437
1.744	-3.0076	6.2004	-293.158
1.76	-4.0362	6.2778	-296.418

Sphere 7 v1= 2.985

time	pos(x)	pos(y)	pos(z)
0	0	0	0
0.016	-0.184	-0.0712	-5.1441
0.032	-0.0862	0.3792	-9.5526
0.048	0.2002	-0.377	-15.5527
0.064	0.9121	-0.0534	-19.6385
0.08	0.2673	-0.1561	-24.1721
0.096	0.4041	-0.1823	-28.3265
0.112	1.0122	-0.3285	-32.6222
0.128	0.8633	-0.3047	-36.0619
0.144	1.246	0.0494	-39.5144
0.16	0.7317	-0.2618	-42.4288

Sphere
7 Cont

time	pos(x)	pos(y)	pos(z)
0.176	0.8917	-0.3754	-45.7381
0.192	0.892	-0.0387	-47.8536
0.208	1.1377	-0.5149	-51.7955
0.224	1.4198	-0.5567	-54.9733
0.24	1.5226	-0.2914	-57.7696
0.256	1.2584	-0.4921	-60.373
0.272	1.2793	-1.2072	-64.2669
0.288	1.4189	-1.2314	-67.0056
0.304	1.7683	-1.8167	-69.9262
0.32	1.6969	-1.7539	-73.056
0.336	2.135	-3.5105	-76.4084
0.352	1.611	-2.9837	-78.6094
0.368	1.0089	-3.4661	-81.1681
0.384	2.035	-3.9585	-83.921
0.4	1.3132	-4.255	-86.2307
0.416	1.3425	-5.135	-89.407
0.432	0.6728	-5.963	-91.0228
0.448	0.8302	-6.3253	-93.0248
0.464	0.5149	-6.5849	-95.578
0.48	1.0753	-7.9396	-98.0801
0.496	0.441	-8.711	-100.398
0.512	0.1963	-9.6783	-102.409
0.528	-0.0931	-10.4351	-104.871
0.544	-0.043	-11.0033	-107.437
0.56	-0.1064	-11.821	-109.106
0.576	-0.3807	-13.0227	-111.178
0.592	-0.2154	-13.2273	-113.109
0.608	-0.1748	-14.0636	-114.525
0.624	-0.2004	-14.9107	-117.11
0.64	-0.1121	-15.5137	-119.067
0.656	0.2997	-17.1754	-121.784
0.672	0.1733	-18.0048	-123.329
0.688	0.29	-19.0615	-125.406
0.704	-0.0809	-19.7612	-127.162
0.72	-0.3838	-20.402	-129.332
0.736	0.1034	-21.3112	-131.703
0.752	0.0532	-22.0887	-133.574
0.768	0.3207	-23.107	-136.123
0.784	0.2295	-23.4865	-137.498
0.8	0.2132	-24.1801	-139.862
0.816	0.0154	-25.9354	-142.464
0.832	0.8253	-25.9161	-143.986
0.848	0.7693	-26.6455	-146.53
0.864	1.0572	-26.9453	-147.689

Sphere
7 Cont

time	pos(x)	pos(y)	pos(z)
0.88	0.7643	-27.4507	-150.579
0.896	0.7437	-28.2031	-152.689
0.912	0.7138	-29.0065	-154.782
0.928	0.9367	-27.4023	-155.604
0.944	1.464	-28.9827	-157.603
0.96	1.7512	-29.1166	-160.243
0.976	1.6742	-29.32	-161.724
0.992	2.2702	-28.9015	-163.654
1.008	2.0006	-28.4484	-165.266
1.024	2.4209	-28.968	-167.122
1.04	2.9185	-28.7308	-169.492
1.056	2.7694	-28.2564	-170.679
1.072	3.1655	-28.4346	-172.352
1.088	3.7783	-28.2375	-173.825
1.104	4.5223	-28.0716	-175.984
1.12	4.4024	-27.9777	-178.369
1.136	4.3874	-27.6504	-180.347
1.152	4.991	-26.8995	-182.104
1.168	5.495	-26.6598	-183.787
1.184	5.6129	-26.3322	-185.244
1.2	5.9828	-25.8084	-188.151
1.216	7.149	-24.9467	-190.312
1.232	7.4026	-24.9389	-192.088
1.248	7.5323	-24.9507	-193.531
1.264	7.3049	-23.7973	-196.16
1.28	7.8308	-23.261	-198.47
1.296	8.9335	-22.7709	-200.706
1.312	9.0343	-23.3725	-203.064
1.328	8.7804	-22.2108	-204.742
1.344	9.0419	-21.5159	-207.262
1.36	9.5911	-21.7833	-208.72
1.376	10.134	-22.0136	-211.289
1.392	10.2605	-21.4354	-212.816
1.408	10.5664	-21.2111	-215.492
1.424	11.0094	-19.8769	-218.261
1.44	11.0052	-20.0936	-219.719
1.456	11.6926	-19.7549	-222.45
1.472	11.8515	-20.2385	-224.16
1.488	12.0482	-18.6631	-226.902
1.504	11.8096	-18.4307	-228.978
1.52	12.3987	-18.2311	-232.043
1.536	12.9537	-18.2779	-234.024
1.552	13.3333	-19.0724	-235.578
1.568	14.0692	-18.9181	-237.844

Sphere
7 Cont

time	pos(x)	pos(y)	pos(z)
1.584	14.189	-18.4013	-240.731
1.6	14.737	-18.8515	-242.658
1.616	15.3359	-18.6215	-245.511
1.632	14.8644	-18.8786	-246.818
1.648	15.3271	-18.116	-249.914
1.664	15.6518	-18.68	-252.053
1.68	14.2179	-19.5916	-253.876
1.696	14.4007	-19.1768	-256.478
1.712	15.2627	-19.0037	-259.109
1.728	15.3591	-19.0039	-261.762
1.744	15.0959	-19.3233	-263.835
1.76	15.5486	-18.9114	-266.343
1.776	15.5827	-18.9324	-268.791
1.792	14.721	-19.5279	-269.765
1.808	15.1114	-19.4641	-272.48
1.824	14.9151	-19.3518	-274.955
1.84	15.0182	-19.5961	-276.985
1.856	15.4222	-19.286	-279.699
1.872	15.6883	-19.0904	-282.416

Sphere 8 v1= 2.564

time	pos(x)	pos(y)	pos(z)
0	0	0	0
0.016	0.2715	-0.1038	-4.6794
0.032	1.3048	0.4185	-8.206
0.048	2.2154	1.6041	-10.554
0.064	3.5001	1.8095	-14.8453
0.08	4.0054	2.1095	-18.7236
0.096	4.2293	2.6323	-21.7566
0.112	5.0576	2.7868	-24.9036
0.128	5.4526	3.9129	-26.9439
0.144	5.3997	4.0306	-30.1195
0.16	5.9651	3.9338	-33.0913
0.176	6.2917	4.8329	-35.9602
0.192	6.7536	5.1947	-37.5777
0.208	5.8959	6.5158	-38.503
0.224	6.8925	6.1998	-43.6997
0.24	6.3462	6.7811	-44.7574
0.256	7.0347	7.1424	-47.497
0.272	5.9813	7.6452	-49.6983
0.288	6.1358	7.5648	-52.8063
0.304	5.0407	8.2872	-54.0518
0.32	4.6227	8.7682	-55.7438
0.336	4.4317	9.1175	-57.1391

Sphere
8 Cont

time	pos(x)	pos(y)	pos(z)
0.352	4.1444	10.1133	-59.9496
0.368	3.3925	9.2091	-62.9327
0.384	3.7484	10.0257	-65.1004
0.4	2.3185	11.0549	-67.1034
0.416	2.3079	11.2545	-69.4193
0.432	1.6029	11.0871	-70.9734
0.448	0.8606	11.4888	-74.5101
0.464	-0.1261	12.2782	-75.6839
0.48	0.0919	12.8389	-77.5886
0.496	-1.5253	12.6447	-80.2816
0.512	-2.1325	13.7085	-83.1564
0.528	-3.1241	14.4649	-83.5614
0.544	-3.3374	15.1549	-85.8156
0.56	-2.9053	15.4027	-87.2047
0.576	-3.6189	14.9867	-88.8675
0.592	-5.1823	16.8892	-91.0569
0.608	-6.3829	16.847	-92.7672
0.624	-7.0224	17.5357	-94.7812
0.64	-8.8498	18.2614	-95.7777
0.656	-10.3547	18.9798	-96.8195
0.672	-11.4511	19.2898	-99.0446
0.688	-13.4346	20.5656	-100.057
0.704	-13.865	20.8825	-102.363
0.72	-15.1161	21.1689	-103.704
0.736	-17.1429	21.7346	-104.457
0.752	-17.8227	22.5283	-106.924
0.768	-17.9613	23.2535	-107.729
0.784	-19.9119	24.2544	-108.469
0.8	-21.1964	25.1737	-110.98
0.816	-22.2847	25.621	-111.868
0.832	-23.7447	26.7132	-113.227
0.848	-24.5827	26.6216	-114.897
0.864	-25.6402	27.7766	-116.07
0.88	-27.9723	28.5159	-117.188
0.896	-29.1259	29.9326	-118.454
0.912	-29.2613	29.4843	-119.339
0.928	-31.0371	31.4677	-120.081
0.944	-31.9682	31.5533	-122.44
0.96	-33.5889	32.3866	-124.163
0.976	-34.5578	32.8058	-125.644
0.992	-36.1638	34.4716	-127.325
1.008	-36.801	34.8675	-128.407
1.024	-37.5304	35.3982	-129.893
1.04	-38.8183	36.5218	-132.161

Sphere
8 Cont

time	pos(x)	pos(y)	pos(z)
1.056	-40.9124	37.9446	-134.221
1.072	-43.6402	38.2674	-135.037
1.088	-44.8187	38.9427	-136.251
1.104	-44.8133	38.9232	-138.248
1.12	-46.3975	40.2223	-139.677
1.136	-47.994	41.5031	-142.013
1.152	-49.6638	43.047	-143.382
1.168	-50.6542	43.075	-145.214
1.184	-52.573	44.3198	-147.724
1.2	-52.7111	44.5932	-149.636
1.216	-54.1273	46.3118	-150.885
1.232	-57.6065	48.9624	-153.445
1.248	-56.3451	48.8401	-155.407
1.264	-58.222	48.6837	-157.998
1.28	-58.7641	50.1518	-158.408
1.296	-58.4629	51.7669	-162.102
1.312	-60.6231	52.3639	-164.083
1.328	-60.6479	52.3287	-166.053
1.344	-62.7041	54.4169	-167.485
1.36	-61.69	54.1181	-169.798
1.376	-64.0128	56.1463	-171.04
1.392	-63.7497	57.0222	-174.42
1.408	-64.9343	58.3818	-176.179
1.424	-64.5783	59.1757	-178.196
1.44	-65.5617	60.068	-179.786
1.456	-65.3844	60.4724	-180.655
1.472	-65.2337	61.8789	-183.301
1.488	-65.7482	63.323	-184.801
1.504	-65.7451	64.2642	-187.334
1.52	-65.7556	65.2595	-188.707
1.536	-65.1568	65.5154	-190.598
1.552	-64.4349	66.4623	-193.07
1.568	-63.6155	67.1826	-194.37
1.584	-62.6151	67.416	-198.192
1.6	-62.7964	69.087	-199.498
1.616	-62.7144	69.9576	-201.339
1.632	-61.9805	69.924	-203.041
1.648	-59.8801	70.1326	-204.103
1.664	-58.9704	70.7566	-205.936
1.68	-59.1673	72.8031	-207.727
1.696	-59.8172	73.7959	-210.301
1.712	-57.6994	72.9431	-212.247
1.728	-58.4229	75.4766	-213.804
1.744	-58.0461	75.1148	-215.915

Sphere
8 Cont

time	pos(x)	pos(y)	pos(z)
1.76	-55.5873	74.4561	-218.263
1.776	-52.8828	74.3303	-221.618
1.792	-52.3397	75.1008	-223.176
1.808	-53.1671	75.7056	-224.576
1.824	-51.5107	76.734	-226.742
1.84	-49.5169	76.4145	-228.556
1.856	-47.2376	76.52	-230.811
1.872	-46.4873	76.7899	-233.097
1.888	-46.3742	76.763	-235.536
1.904	-43.7547	77.1148	-238.437
1.92	-43.7045	77.4768	-239.636
1.936	-41.9856	76.9485	-242.689
1.952	-41.4393	77.8541	-243.454
1.968	-38.1477	77.1665	-246.558
1.984	-37.2849	77.1812	-249.914
2	-36.1998	76.2081	-251.852
2.016	-35.3133	77.5331	-254.129
2.032	-34.2775	77.115	-255.463
2.048	-31.0485	75.9552	-257.778
2.064	-30.859	75.87	-260.698
2.08	-29.9106	75.1959	-262.197
2.096	-28.3423	73.7525	-263.335
2.112	-27.2839	73.5881	-267.716
2.128	-25.1003	71.9315	-269.804
2.144	-23.8864	73.5349	-273.017
2.16	-22.2512	73.1885	-275.2
2.176	-22.7219	71.9709	-275.197
2.192	-20.2	70.3058	-278.928
2.208	-19.05	69.9335	-280.395
2.224	-19.2453	69.4419	-282.395
2.24	-16.6431	68.1974	-285.219
2.256	-15.4802	67.152	-287.253
2.272	-14.8487	66.1452	-288.801
2.288	-12.0327	65.1396	-291.048
2.304	-10.9571	64.2785	-292.931
2.32	-11.0836	64.7326	-294.769
2.336	-9.9335	61.6965	-297.227
2.352	-7.1611	61.1931	-298.394
2.368	-6.9109	59.5356	-299.798
2.384	-5.1212	58.8987	-303.429
2.4	-3.7126	58.7868	-304.918
2.416	-2.185	56.5265	-306.499
2.432	-1.7335	55.0273	-308.018
2.448	-2.2996	55.4391	-310.398

Sphere
8 Cont

time	pos(x)	pos(y)	pos(z)
2.464	-1.4875	53.9372	-312.159
2.48	0.2383	52.4822	-314.006
2.496	1.9647	52.1502	-315.425
2.512	1.376	51.5754	-318.313
2.528	3.6109	49.1545	-319.249
2.544	3.8549	48.6457	-320.382
2.56	4.5397	48.3112	-324.041

Sphere 9 v1= 3.290

time	pos(x)	pos(y)	pos(z)
0	0	0	0
0.016	1.0043	-0.0882	-4.4566
0.032	2.5013	-0.9715	-10.5284
0.048	3.2664	0.2293	-13.5933
0.064	3.7617	0.511	-16.822
0.08	5.4411	1.3812	-20.9894
0.096	6.4389	1.8326	-23.6774
0.112	7.1181	3.1216	-26.1661
0.128	8.4503	3.3398	-29.6962
0.144	8.7388	3.6285	-32.7394
0.16	8.6706	4.2467	-36.2287
0.176	9.3199	4.9535	-38.0638
0.192	11.1906	4.9176	-40.4369
0.208	11.9708	5.9553	-43.1404
0.224	10.9928	6.0783	-46.376
0.24	11.9666	6.6596	-48.6117
0.256	11.2584	6.5389	-52.2754
0.272	10.5185	7.6771	-54.3595
0.288	10.5944	7.451	-56.8925
0.304	12.0105	8.673	-59.8028
0.32	11.2868	9.9058	-61.7213
0.336	12.5541	10.0875	-64.219
0.352	12.0265	11.3197	-66.6766
0.368	11.2476	11.5507	-69.2051
0.384	11.2144	12.1064	-70.8142
0.4	11.2416	13.2821	-74.1867
0.416	10.3495	14.4629	-76.5738
0.432	11.3243	14.6487	-78.4749
0.448	11.3573	15.3432	-80.5763
0.464	10.4365	16.2567	-82.3462
0.48	10.3136	17.621	-84.3788
0.496	9.8651	18.7621	-86.4503
0.512	10.7634	19.5575	-87.7842
0.528	10.9768	21.2012	-90.2999

Sphere
9 Cont

time	pos(x)	pos(y)	pos(z)
0.544	8.8163	22.6933	-91.6601
0.56	7.5775	22.9004	-92.7584
0.576	8.3759	24.1426	-95.0789
0.592	7.9382	25.3209	-96.5762
0.608	7.7586	26.7823	-98.9911
0.624	7.7536	26.9327	-100.345
0.64	7.8604	29.3578	-101.081
0.656	7.8755	29.9821	-103.617
0.672	7.3237	31.0667	-105.538
0.688	7.6834	32.8075	-106.528
0.704	6.8736	34.1902	-108.486
0.72	7.7349	34.8762	-111.009
0.736	7.0026	36.585	-112.716
0.752	7.3419	38.0734	-114.746
0.768	6.2078	39.2379	-116.58
0.784	6.5431	41.4053	-117.914
0.8	7.3158	40.4962	-120.362
0.816	7.9837	42.6035	-122.971
0.832	6.7656	44.4403	-125.495
0.848	7.5205	45.3488	-126.854
0.864	8.6812	45.9924	-129.272
0.88	7.7994	47.5868	-130.792
0.896	8.4538	48.9487	-133.013
0.912	8.2624	50.3858	-135.216
0.928	9.8653	52.4959	-137.536
0.944	9.979	53.5049	-140.17
0.96	10.9377	54.65	-143.134
0.976	11.3332	56.2864	-145.622
0.992	11.4632	57.7293	-147.422
1.008	10.8693	58.6878	-149.408
1.024	12.3083	60.703	-152.283
1.04	12.5696	62.2197	-155.466
1.056	12.6586	63.5097	-157.644
1.072	12.7826	65.0394	-159.175
1.088	13.5622	66.2469	-161.962
1.104	14.9775	66.9117	-164.54
1.12	15.1328	68.4663	-167.441
1.136	15.5905	69.713	-170.108
1.152	17.1626	71.0228	-173.18
1.168	18.7385	72.1261	-176.391
1.184	17.4681	73.7591	-178.933
1.2	18.6704	74.5431	-182.217
1.216	18.3576	75.1248	-184.089
1.232	20.0527	76.6712	-188.147

Sphere
9 Cont

time	pos(x)	pos(y)	pos(z)
1.248	20.1478	77.3378	-191.586
1.264	18.3534	78.0498	-194.271
1.28	21.4299	78.0915	-198.428
1.296	22.0429	79.4983	-201.446
1.312	21.999	78.8365	-205.118
1.328	22.6212	80.1378	-207.228
1.344	23.4162	79.8936	-210.936
1.36	23.4638	79.8301	-214.46
1.376	24.8171	80.846	-217.669
1.392	23.1728	79.6343	-222.062
1.408	23.9948	79.0628	-225.93
1.424	24.0386	78.9037	-228.667
1.44	25.3025	76.357	-231.739
1.456	24.2986	77.2342	-234.698
1.472	26.5101	75.6654	-239.747
1.488	25.3899	75.0893	-241.902
1.504	25.2444	73.812	-244.739
1.52	25.6384	72.7683	-248.627
1.536	25.9923	71.6568	-252.494
1.552	27.3285	69.9439	-253.867
1.568	27.0946	70.3756	-257.812
1.584	27.2912	68.154	-259.219
1.6	28.2667	66.8831	-261.825
1.616	28.7221	65.5856	-265.867
1.632	28.6422	64.6723	-268.934
1.648	27.4174	65.3655	-270.85
1.664	28.7275	63.9447	-274.126
1.68	29.4392	63.7024	-276.977
1.696	30.0991	61.6787	-280.832
1.712	30.7416	60.8342	-282.757
1.728	30.9309	60.0572	-285.245
1.744	31.8416	57.6528	-287.76
1.76	32.7128	56.9557	-291.207
1.776	32.2313	55.121	-293.53
1.792	33.9413	51.3705	-294.123
1.808	33.3001	50.9679	-296.594
1.824	33.9258	50.2041	-299.08
1.84	34.082	49.2198	-302.006
1.856	34.0047	48.0745	-304.669
1.872	35.6633	45.4832	-307.321
1.888	35.4895	44.2922	-309.473
1.904	34.4877	44.1807	-312.116
1.92	35.9074	42.6795	-314.671
1.936	36.2363	41.2058	-315.9

Sphere
9 Cont

time	pos(x)	pos(y)	pos(z)
1.952	33.5133	40.2434	-318.944
1.968	34.8987	39.0327	-321.229
1.984	33.4748	38.211	-323.741
2	32.1678	36.1742	-325.343
2.016	34.3218	33.8232	-328.577
2.032	33.8983	32.9702	-330.821
2.048	33.7541	33.1427	-332.462

Sphere 10 v1= 2.898

time	pos(x)	pos(y)	pos(z)
0	0	0	0
0.016	0.2816	-0.1891	-4.1479
0.032	1.0624	-0.1013	-9.2744
0.048	1.5767	0.7627	-12.4086
0.064	2.4657	1.2753	-16.2766
0.08	3.4405	1.792	-19.7436
0.096	4.0165	2.2354	-22.5047
0.112	5.3583	2.2463	-26.7036
0.128	6.5478	3.4118	-28.9776
0.144	5.9327	3.8991	-30.9188
0.16	6.5501	4.1895	-33.1716
0.176	6.4618	4.1289	-37.3644
0.192	7.5694	4.7764	-39.9097
0.208	9.0866	4.7578	-42.0188
0.224	8.2615	5.5888	-44.7806
0.24	7.8987	5.1879	-48.9284
0.256	8.0621	5.5056	-50.6355
0.272	8.0377	6.1963	-52.6203
0.288	8.4151	6.4131	-55.9794
0.304	7.8984	6.3994	-57.762
0.32	8.7595	7.1307	-60.8971
0.336	8.6364	7.0071	-63.8707
0.352	7.8372	6.9951	-66.1781
0.368	8.3957	6.9015	-68.2801
0.384	8.5043	6.9983	-71.3724
0.4	8.9095	6.5642	-73.8778
0.416	8.1191	6.4401	-75.8467
0.432	8.4624	5.7351	-79.7364
0.448	8.673	6.1782	-82.5537
0.464	8.6284	6.4947	-84.3494
0.48	8.326	5.5197	-87.0449
0.496	8.3397	5.1574	-89.193
0.512	8.1508	4.6466	-91.6729
0.528	8.2405	4.1007	-93.7392

Sphere
10 Cont

time	pos(x)	pos(y)	pos(z)
0.544	8.0315	2.5997	-95.3759
0.56	7.5179	2.6617	-97.0656
0.576	8.4085	2.4552	-99.6407
0.592	8.0722	1.8644	-102.08
0.608	8.1665	1.8691	-102.944
0.624	8.693	1.0222	-104.893
0.64	8.9583	0.3897	-107.175
0.656	9.7789	-0.1283	-108.668
0.672	9.7266	-0.0221	-110.744
0.688	9.7365	-0.5499	-112.993
0.704	10.041	-1.6588	-114.965
0.72	10.4188	-2.778	-116.605
0.736	9.7425	-3.1508	-118.389
0.752	10.4416	-3.6692	-119.995
0.768	10.9418	-4.3947	-122.128
0.784	10.9961	-4.8896	-124.49
0.8	11.5761	-6.0876	-126.482
0.816	11.8504	-6.2129	-128.253
0.832	12.7788	-6.5522	-130.451
0.848	13.0712	-7.8598	-132.742
0.864	13.5873	-8.326	-134.841
0.88	14.0905	-9.0491	-136.215
0.896	14.6606	-9.3437	-138.731
0.912	15.0364	-9.9819	-140.303
0.928	16.1058	-10.5148	-142.212
0.944	17.1856	-11.2382	-144.339
0.96	18.0855	-11.5997	-146.862
0.976	17.4536	-11.8072	-147.87
0.992	17.788	-13.6462	-151.251
1.008	18.7391	-13.6884	-153.292
1.024	19.9841	-13.4949	-155.379
1.04	21.1332	-14.2686	-157.957
1.056	20.4476	-13.8801	-160.576
1.072	21.4243	-13.89	-161.842
1.088	21.9386	-14.2771	-163.937
1.104	22.4798	-14.3756	-165.988
1.12	23.0099	-14.5873	-168.246
1.136	23.715	-14.3709	-170.67
1.152	24.3883	-14.0687	-172.188
1.168	24.5017	-13.8115	-174.29
1.184	24.9668	-12.9473	-176.147
1.2	26.4988	-12.5456	-178.758
1.216	27.5919	-12.8635	-180.953
1.232	27.7881	-12.3081	-182.976

Sphere
10 Cont

time	pos(x)	pos(y)	pos(z)
1.248	27.9239	-11.929	-184.63
1.264	28.8299	-11.1031	-186.549
1.28	29.9985	-11.2604	-189.05
1.296	31.1741	-10.2969	-190.989
1.312	31.0742	-9.4614	-193.392
1.328	31.8458	-9.0748	-195.095
1.344	32.6195	-8.1555	-197.611
1.36	33.0834	-7.5257	-199.929
1.376	33.371	-7.3768	-202.069
1.392	34.2602	-6.7538	-204.411
1.408	34.3159	-5.5542	-206.732
1.424	34.6759	-5.7708	-208.149
1.44	35.3011	-5.3403	-211.253
1.456	35.7107	-4.9568	-213.999
1.472	36.5519	-4.5168	-217.003
1.488	37.4769	-4.5116	-219.136
1.504	37.3848	-4.2496	-221.431
1.52	35.5538	-2.9894	-224.165
1.536	36.797	-3.3018	-226.658
1.552	37.2192	-3.5129	-229.6
1.568	37.1034	-3.3326	-231.732
1.584	37.3467	-2.7408	-234.317
1.6	37.4393	-3.249	-237.225
1.616	37.3425	-3.0046	-239.899
1.632	37.3626	-3.061	-242.123
1.648	37.4182	-4.1088	-244.571
1.664	36.5585	-4.2607	-247.641
1.68	36.1354	-4.8801	-249.737
1.696	36.0722	-5.2141	-252.009
1.712	36.0274	-4.829	-254.214
1.728	34.9615	-5.6359	-257.348
1.744	35.1519	-5.7383	-259.744
1.76	34.7806	-6.8905	-261.568
1.776	34.8494	-6.2374	-264.083
1.792	34.0906	-7.0603	-265.531
1.808	32.99	-7.1133	-268.802
1.824	32.2344	-7.5734	-271.218
1.84	32.373	-7.767	-273.368
1.856	31.4449	-8.7558	-275.499
1.872	31.0614	-8.7156	-276.899
1.888	29.16	-10.0612	-278.983
1.904	29.1044	-9.1478	-282.084
1.92	28.5153	-10.5598	-283.995
1.936	27.6725	-10.6265	-286.731

Sphere
10 Cont

time	pos(x)	pos(y)	pos(z)
1.952	26.8061	-11.3919	-288.121
1.968	26.0263	-12.9455	-291.784
1.984	25.6881	-13.1528	-294.224
2	25.6045	-13.4972	-295.962
2.016	24.3341	-13.7435	-298.295
2.032	24.6301	-13.9134	-300.738
2.048	24.61	-14.0483	-303.203
2.064	23.2632	-14.5246	-305.796
2.08	23.2997	-14.9854	-307.98
2.096	23.5449	-15.0323	-310.482
2.112	23.1801	-15.0289	-312.712

Sphere 11 v1= 2.789

time	pos(x)	pos(y)	pos(z)
0	0	0	0
0.016	0.1719	0.0318	-5.0605
0.032	2.1238	0.7831	-8.9258
0.048	1.8027	1.394	-11.3444
0.064	3.434	2.0558	-15.5601
0.08	4.1292	3.0188	-18.5583
0.096	4.2647	2.179	-22.7825
0.112	4.8505	3.5612	-25.6962
0.128	5.6381	3.9065	-28.9365
0.144	7.0204	4.3472	-32.0053
0.16	6.5372	4.9776	-34.8339
0.176	6.2946	5.4321	-38.078
0.192	6.756	5.1571	-41.2815
0.208	6.1137	5.7324	-43.5643
0.224	5.208	6.0712	-46.1859
0.24	5.3738	6.4518	-48.6821
0.256	5.0085	7.009	-51.4146
0.272	4.7374	7.5468	-53.8316
0.288	4.3056	7.8449	-56.7294
0.304	3.7787	7.3138	-59.1842
0.32	3.3722	6.8974	-62.2476
0.336	3.2675	7.5787	-64.4782
0.352	2.9746	8.4759	-67.2005
0.368	2.1644	8.5941	-70.0933
0.384	1.2834	8.7165	-72.6329
0.4	0.4983	8.7008	-75.0339
0.416	-0.1445	8.9403	-77.5928
0.432	-1.7182	9.2429	-80.6488
0.448	-2.2739	8.544	-82.9981
0.464	-3.9194	9.5565	-85.5703

Sphere
11 Cont

time	pos(x)	pos(y)	pos(z)
0.48	-4.7752	9.6289	-88.3635
0.496	-7.0497	9.459	-90.1786
0.512	-6.5811	9.0179	-92.7257
0.528	-7.2507	9.6119	-94.9697
0.544	-8.5981	8.8201	-97.1135
0.56	-10.5102	9.4389	-99.7624
0.576	-11.547	9.3592	-101.056
0.592	-13.0547	9.0587	-103.96
0.608	-13.6039	8.2596	-106.37
0.624	-15.272	8.2255	-108.496
0.64	-15.7065	8.5247	-110.691
0.656	-16.9576	8.5195	-112.356
0.672	-17.117	8.0623	-114.527
0.688	-18.2445	7.3952	-116.558
0.704	-20.1923	6.5694	-119.249
0.72	-22.3277	6.811	-120.86
0.736	-22.1258	7.4373	-123.552
0.752	-22.8847	6.3096	-125.361
0.768	-24.8554	5.9577	-126.77
0.784	-26.5858	6.5427	-129.17
0.8	-28.144	5.2141	-130.932
0.816	-27.9574	4.7723	-134.479
0.832	-28.9577	4.5854	-136.152
0.848	-30.1836	3.4485	-138.404
0.864	-30.5169	2.6689	-140.305
0.88	-31.0383	1.683	-142.508
0.896	-31.8405	1.5335	-144.728
0.912	-33.4378	1.4018	-146.301
0.928	-33.6195	0.2653	-148.268
0.944	-32.8568	-0.4129	-150.128
0.96	-34.147	-0.9389	-152.118
0.976	-34.924	-2.3801	-154.436
0.992	-34.6635	-2.9713	-156.895
1.008	-35.9054	-4.2401	-158.546
1.024	-36.765	-5.4325	-160.844
1.04	-36.3212	-6.285	-162.61
1.056	-37.665	-6.365	-164.196
1.072	-39.7517	-6.6409	-166.059
1.088	-39.7089	-8.31	-168.139
1.104	-39.1341	-8.9088	-170.57
1.12	-39.8255	-10.1384	-171.938
1.136	-40.049	-11.545	-174.036
1.152	-40.2444	-12.3061	-175.435
1.168	-40.5765	-13.1995	-177.933

Sphere
11 Cont

time	pos(x)	pos(y)	pos(z)
1.184	-41.3664	-14.5576	-179.866
1.2	-41.2208	-15.3347	-182.025
1.216	-40.5557	-16.8209	-184.326
1.232	-41.2511	-17.152	-185.931
1.248	-42.1272	-18.0345	-187.559
1.264	-41.982	-20.0822	-189.829
1.28	-40.5773	-22.4883	-191.761
1.296	-40.1005	-23.3773	-194.132
1.312	-39.9688	-24.3096	-195.9
1.328	-39.8935	-25.5784	-197.628
1.344	-39.9462	-26.4687	-199.348
1.36	-39.4846	-27.8096	-201.641
1.376	-38.2727	-29.2982	-203.325
1.392	-39.3818	-29.6242	-205.465
1.408	-37.9109	-32.2637	-206.274
1.424	-37.9467	-32.658	-208.165
1.44	-36.7855	-34.544	-210.226
1.456	-36.4069	-35.2475	-211.888
1.472	-36.224	-36.2999	-214.021
1.488	-36.1751	-36.9101	-216.093
1.504	-35.0522	-38.3477	-217.027
1.52	-34.6778	-39.4667	-218.422
1.536	-33.9669	-40.2678	-219.941
1.552	-33.5139	-41.7429	-221.79
1.568	-32.788	-42.2199	-224.163
1.584	-32.9001	-43.298	-225.444
1.6	-31.9869	-44.2525	-227.104
1.616	-31.521	-44.8693	-229.374
1.632	-30.842	-45.3428	-230.645
1.648	-31.3611	-46.2146	-232.879
1.664	-30.7456	-47.2527	-233.859
1.68	-30.1818	-47.4678	-236.191
1.696	-29.2647	-49.162	-237.733
1.712	-29.5752	-48.8205	-239.622
1.728	-29.1689	-48.0963	-242.88
1.744	-28.8869	-48.4082	-244.216
1.76	-27.1968	-49.3074	-245.927
1.776	-27.0386	-49.0426	-247.886
1.792	-26.1591	-49.5757	-250.045
1.808	-25.5938	-50.1313	-251.986
1.824	-24.8409	-50.0367	-253.853
1.84	-23.0799	-50.3513	-256.328
1.856	-23.4332	-49.6488	-258.521
1.872	-23.0694	-49.1796	-260.938

Sphere
11 Cont

time	pos(x)	pos(y)	pos(z)
1.888	-22.6473	-49.5997	-262.769
1.904	-22.3663	-49.3916	-264.674
1.92	-21.3372	-49.1074	-266.719
1.936	-21.6998	-48.0791	-269.65
1.952	-20.9084	-48.3208	-271.842
1.968	-20.0746	-47.8405	-274.22
1.984	-19.4214	-47.5151	-275.835

Sphere 12 v1= 2.800

time	pos(x)	pos(y)	pos(z)
0	0	0	0
0.016	0.172	0.2111	-4.9084
0.032	0.2879	0.2682	-8.9601
0.048	1.5793	0.0935	-14.1038
0.064	2.5903	0.426	-16.8551
0.08	3.3109	1.4381	-20.0243
0.096	3.5558	1.8736	-23.4424
0.112	4.2576	3.7751	-25.7677
0.128	5.0979	3.0067	-29.1755
0.144	5.161	3.7535	-31.7727
0.16	6.271	3.9582	-35.2679
0.176	6.5616	4.0854	-37.7896
0.192	7.1632	5.1461	-40.3581
0.208	7.7102	5.1627	-42.5751
0.224	7.5657	5.0113	-45.732
0.24	7.0894	5.8879	-47.4159
0.256	5.8693	6.9491	-50.9932
0.272	6.6582	7.2241	-53.0076
0.288	6.1027	6.9955	-56.407
0.304	5.7804	7.1696	-58.3402
0.32	4.5713	7.7926	-60.3125
0.336	3.7367	7.6715	-62.571
0.352	2.8411	7.761	-64.9986
0.368	2.925	8.0028	-67.374
0.384	2.7053	8.8453	-69.6923
0.4	2.3901	8.4062	-71.8248
0.416	1.2413	7.8072	-74.4572
0.432	-0.5898	9.2786	-76.1958
0.448	-0.8404	9.5346	-78.8173
0.464	-2.5436	9.3921	-80.7683
0.48	-2.2941	9.9491	-82.9291
0.496	-2.3757	10.154	-85.5451
0.512	-3.1695	10.4606	-88.4096
0.528	-3.6806	10.791	-90.1287

Sphere
12 Cont

time	pos(x)	pos(y)	pos(z)
0.544	-3.8296	10.2457	-92.5867
0.56	-5.0671	10.8972	-94.5857
0.576	-6.3839	11.3935	-96.6048
0.592	-8.6167	11.7071	-98.724
0.608	-8.925	11.9332	-100.437
0.624	-10.017	12.2123	-102.674
0.64	-11.4768	11.9977	-104.672
0.656	-13.0717	12.6198	-106.473
0.672	-14.6363	13.3184	-108.322
0.688	-15.5822	13.6799	-110.41
0.704	-16.5818	14.2602	-112.597
0.72	-18.7158	14.7623	-113.735
0.736	-18.9557	14.6581	-115.962
0.752	-21.1373	15.1562	-117.778
0.768	-21.9613	15.4754	-119.807
0.784	-22.4281	16.1046	-121.575
0.8	-24.9926	16.3496	-122.279
0.816	-25.7451	16.1025	-124.153
0.832	-27.2859	17.0219	-126.256
0.848	-30.1907	17.2582	-128.095
0.864	-31.2941	17.556	-129.406
0.88	-33.1411	18.4839	-131.003
0.896	-35.1246	19.1467	-132.446
0.912	-35.3461	18.8999	-133.799
0.928	-36.5395	19.113	-135.96
0.944	-38.3449	20.0546	-137.037
0.96	-40.2293	20.2958	-138.638
0.976	-42.214	21.2446	-140.903
0.992	-45.0547	22.4693	-142.623
1.008	-46.0578	22.8015	-144.344
1.024	-46.8754	22.7339	-145.475
1.04	-48.3662	23.1272	-146.835
1.056	-50.9842	25.1324	-148.707
1.072	-52.6038	24.9058	-151.637
1.088	-53.6851	25.4524	-153.659
1.104	-55.3077	25.9369	-155.699
1.12	-56.4069	26.5506	-157.694
1.136	-59.1143	28.3191	-160.471
1.152	-60.7707	28.2497	-163.227
1.168	-63.1096	29.009	-165.288
1.184	-63.4799	28.9706	-167.805
1.2	-65.161	30.149	-170.148
1.216	-66.5166	30.5573	-172.454
1.232	-68.1497	31.5446	-174.661

Sphere
12 Cont

time	pos(x)	pos(y)	pos(z)
1.248	-68.0948	31.3502	-177.498
1.264	-69.8988	32.5829	-181.101
1.28	-69.7458	32.8902	-182.432
1.296	-70.6361	32.8865	-183.977
1.312	-71.2792	33.5537	-187.236
1.328	-71.9121	34.2671	-189.57
1.344	-71.9063	34.1643	-192.082
1.36	-71.4719	34.4681	-194.292
1.376	-71.4302	34.3104	-196.457
1.392	-71.8789	35.3016	-199.439
1.408	-72.9387	35.653	-202.078
1.424	-72.8439	36.0386	-204.339
1.44	-72.4443	35.8076	-207.638
1.456	-71.818	35.7442	-210.182
1.472	-71.1746	36.4287	-213.029
1.488	-70.5812	36.4372	-214.615
1.504	-70.5515	37.0205	-216.505
1.52	-71.2627	38.0451	-219.42
1.536	-70.7549	38.365	-222.808
1.552	-69.0739	38.1446	-225.473
1.568	-67.8962	38.4151	-227.78
1.584	-66.6131	38.1839	-229.871
1.6	-67.464	38.9916	-232.527
1.616	-66.4823	38.7129	-234.824
1.632	-64.6248	38.9597	-238.188
1.648	-64.29	38.8564	-239.996
1.664	-63.8894	38.3567	-243.353
1.68	-62.1176	38.6871	-247.163
1.696	-61.1962	38.0118	-249.352
1.712	-61.482	38.8305	-252.453
1.728	-60.5509	39.1373	-254.296
1.744	-58.8988	37.7797	-258.376
1.76	-57.7129	37.1784	-259.684
1.776	-58.1424	37.5864	-263.356
1.792	-58.1107	37.1437	-266.223
1.808	-56.6448	35.9082	-268.798
1.824	-56.003	36.6034	-270.987
1.84	-57.0018	36.5736	-275.139
1.856	-56.0466	35.7634	-276.613
1.872	-53.6762	34.5529	-280.126
1.888	-53.0514	33.2302	-281.803
1.904	-52.9564	32.1356	-284.724
1.92	-52.5268	31.322	-287.691
1.936	-53.1542	31.5451	-290.128

Sphere
12 Cont

time	pos(x)	pos(y)	pos(z)
1.952	-53.8468	31.2686	-292.844
1.968	-53.0736	30.1441	-294.888
1.984	-51.4005	29.0925	-298.062
2	-52.7677	28.1663	-300.395
2.016	-52.3292	27.8139	-302.733
2.032	-52.1577	25.8839	-304.668
2.048	-50.9226	23.9605	-306.794
2.064	-52.0353	24.4298	-308.151
2.08	-51.4564	23.0616	-311.076
2.096	-50.3899	21.5747	-313.005
2.112	-50.3178	20.3822	-315.769
2.128	-51.1188	19.578	-317.871

Sphere 13 v1= 3.001

time	pos(x)	pos(y)	pos(z)
0	0	0	0
0.016	1.1164	-0.6036	-5.5601
0.032	1.7199	-0.042	-9.6041
0.048	3.0425	0.5127	-13.2053
0.064	4.0413	0.8391	-17.3374
0.08	5.2801	2.1232	-19.9891
0.096	6.6595	2.1297	-23.0843
0.112	6.4262	3.4856	-26.4461
0.128	8.0373	4.15	-28.7996
0.144	8.7232	4.0648	-31.0021
0.16	9.0754	4.7086	-34.4701
0.176	9.3864	4.7161	-37.0637
0.192	9.6255	5.5734	-39.3267
0.208	9.7682	5.7247	-42.3242
0.224	9.7112	6.297	-44.4059
0.24	8.7498	6.3512	-47.4815
0.256	8.9637	7.7717	-49.0594
0.272	8.7067	8.0363	-51.7051
0.288	9.2054	8.2421	-54.3903
0.304	8.0268	9.233	-56.7723
0.32	7.8089	9.9271	-58.1381
0.336	8.0518	9.6924	-60.1973
0.352	7.3439	10.7211	-62.6804
0.368	7.842	11.638	-64.8254
0.384	7.1301	12.5371	-66.8498
0.4	6.5893	12.7044	-68.6233
0.416	5.1163	13.5262	-70.2759
0.432	4.8382	14.4728	-72.7371
0.448	4.3758	14.4945	-74.9372

Sphere
13 Cont

time	pos(x)	pos(y)	pos(z)
0.464	3.0965	15.6354	-76.4353
0.48	1.7112	16.084	-77.1463
0.496	0.8063	16.0463	-79.7187
0.512	0.1597	17.368	-81.4961
0.528	-0.5218	18.1278	-83.1993
0.544	-2.5212	18.6573	-84.8612
0.56	-3.4123	18.9492	-86.3887
0.576	-3.5265	20.1982	-88.1309
0.592	-5.3509	20.3558	-89.3675
0.608	-6.1028	20.8905	-91.0045
0.624	-6.7562	21.9703	-92.5028
0.64	-7.9813	22.9746	-94.5896
0.656	-9.3257	23.5419	-95.5097
0.672	-12.4697	24.9965	-98.1927
0.688	-12.8716	25.331	-99.8016
0.704	-14.628	26.8438	-101.126
0.72	-14.6954	27.0238	-103.284
0.736	-17.0202	27.7521	-104.459
0.752	-17.5641	29.2908	-106.337
0.768	-18.6822	29.082	-108.212
0.784	-18.5969	30.3808	-109.705
0.8	-20.1616	30.9761	-111.466
0.816	-21.0327	31.2818	-113.189
0.832	-23.3266	32.6096	-115.164
0.848	-23.3412	33.5876	-117.184
0.864	-24.8396	34.034	-118.885
0.88	-25.7093	35.2332	-120.996
0.896	-25.69	35.6167	-122.122
0.912	-27.2751	37.2225	-124.697
0.928	-28.2314	37.5244	-126.301
0.944	-28.7207	38.3494	-128.578
0.96	-28.9527	38.7484	-130.384
0.976	-31.6865	41.1075	-131.416
0.992	-32.2739	41.8546	-134.053
1.008	-32.4772	42.989	-136.043
1.024	-33.254	43.5143	-138.672
1.04	-34.1835	44.7256	-140.596
1.056	-35.7638	45.8381	-142.719
1.072	-36.5246	47.8226	-144.45
1.088	-35.9124	47.8504	-146.58
1.104	-35.0362	49.4414	-149.66
1.12	-35.7518	49.6161	-151.671
1.136	-37.0209	50.7124	-153.194
1.152	-36.3732	51.9267	-156.514

Sphere
13 Cont

time	pos(x)	pos(y)	pos(z)
1.168	-35.5505	52.8756	-158.097
1.184	-36.0056	53.5483	-159.087
1.2	-34.3742	55.4917	-161.788
1.216	-35.5051	56.1542	-163.816
1.232	-35.1615	57.5448	-166.591
1.248	-33.1388	57.9002	-167.228
1.264	-32.4073	59.319	-170.515
1.28	-31.5603	60.7353	-171.875
1.296	-32.4933	61.9763	-174.423
1.312	-31.9457	63.224	-175.939
1.328	-31.306	63.2612	-178.134
1.344	-30.3972	64.1813	-180.672
1.36	-29.439	65.1771	-181.571
1.376	-27.7429	65.7428	-184.721
1.392	-27.8291	66.6089	-185.75
1.408	-26.5359	67.8036	-189.072
1.424	-25.9036	68.8218	-191.209
1.44	-24.4994	69.4666	-193.373
1.456	-23.7659	69.5101	-195.01
1.472	-21.6017	70.2669	-197.201
1.488	-21.6537	71.0154	-199.12
1.504	-19.7813	70.9522	-201.243
1.52	-19.1028	72.3746	-204.637
1.536	-19.0884	72.5155	-206.969
1.552	-16.0538	73.0692	-209.883
1.568	-14.9171	73.468	-212.041
1.584	-14.8629	73.4708	-214.264
1.6	-12.9388	73.4652	-216.699
1.616	-11.6997	73.5213	-219.502
1.632	-9.4434	74.7805	-221.468
1.648	-7.1521	74.0708	-222.785
1.664	-5.8705	74.8967	-226.657
1.68	-3.5687	74.8726	-228.522
1.696	-3.8203	75.2218	-231.987
1.712	-3.3924	75.2436	-233.635
1.728	-2.1905	75.3558	-236.805
1.744	-2.0993	75.173	-239.041
1.76	-0.4099	73.6359	-241.64
1.776	-0.335	73.7324	-244.114
1.792	1.217	74.038	-246.036
1.808	2.0622	73.9022	-249.268
1.824	5.0598	72.1249	-251.809
1.84	5.3012	72.0186	-255.487
1.856	5.6744	71.7292	-256.716

Sphere
13 Cont

time	pos(x)	pos(y)	pos(z)
1.872	6.5882	71.1241	-260.502
1.888	8.618	70.0926	-260.867
1.904	9.2146	69.8181	-263.245
1.92	11.2006	69.6595	-268.736
1.936	11.4981	67.2998	-268.841
1.952	12.0161	67.0668	-271.389
1.968	12.8162	65.7774	-273.65
1.984	14.6961	65.7149	-276.562
2	15.5011	64.5548	-278.826
2.016	16.3249	63.4709	-280.49
2.032	17.4562	62.0352	-282.284
2.048	16.1561	61.248	-284.52
2.064	18.2531	60.3662	-286.75
2.08	17.5865	58.9976	-289.685
2.096	17.6177	57.7973	-291.621
2.112	20.3528	57.1668	-293.909
2.128	21.6213	55.5668	-295.62
2.144	22.1116	54.212	-296.876
2.16	22.4864	53.2963	-299.943
2.176	22.1167	51.9707	-302.163
2.192	23.1486	50.7038	-304.146
2.208	23.2147	50.0228	-307.45
2.224	24.6818	49.0907	-309.2
2.24	24.1461	47.7055	-311.786
2.256	25.8349	46.4456	-312.498
2.272	24.7191	44.8968	-314.555
2.288	24.1377	45.2107	-317.392
2.304	24.4158	43.9045	-318.97
2.32	25.5706	42.3692	-322.522
2.336	26.3746	41.6101	-324.054

Gumdrop Data Table

Gumdrop

time	pos(x)	pos(y)	pos(z)
0	0	0	0
0.016	1.0313	0.088	-6.7107
0.032	1.5842	-0.3701	-11.935
0.048	2.8163	0.1155	-16.4745
0.064	4.2252	-0.1493	-21.4811
0.08	3.9794	-0.1232	-25.392
0.096	4.8729	0.1467	-30.1131
0.112	5.6435	0.3403	-34.8387
0.128	6.6098	-0.1697	-39.1964

Gumdrop
I Cont

time	pos(x)	pos(y)	pos(z)
0.144	7.2556	0.717	-42.5271
0.16	7.6582	0.7324	-45.5966
0.176	9.179	1.0153	-49.2913
0.192	8.6543	0.9647	-52.4792
0.208	9.7967	1.4022	-55.4826
0.224	10.9369	1.6574	-58.8066
0.24	12.0167	1.0555	-61.4609
0.256	12.4174	2.7847	-63.6598
0.272	13.9569	2.4742	-66.7733
0.288	14.4284	3.4496	-69.3399
0.304	16.3135	4.0322	-71.5085
0.32	17.2592	4.8391	-73.8025
0.336	18.4773	4.801	-77.1285
0.352	19.1196	5.2653	-79.0883
0.368	20.5566	6.6132	-80.807
0.384	20.9986	6.9793	-82.1105
0.4	21.3874	7.6238	-84.2038
0.416	21.965	7.5587	-87.1324
0.432	22.6716	8.479	-89.2186
0.448	23.2354	8.7121	-91.7596
0.464	23.7762	8.4305	-93.9615
0.48	25.2158	9.821	-96.2828
0.496	26.0538	11.0124	-98.6565
0.512	25.8299	10.2586	-101.253
0.528	25.9174	11.3351	-102.633
0.544	26.9214	11.7571	-105.531
0.56	27.4533	12.5588	-108.541
0.576	27.8983	12.5609	-110.952
0.592	27.9994	13.9392	-113.412
0.608	28.4657	14.0268	-116.6
0.624	27.8964	14.0977	-118.998
0.64	28.3111	15.1427	-121.466
0.656	28.4432	15.4299	-123.819
0.672	29.4087	16.6356	-126.856
0.688	29.9839	18.0353	-129.394
0.704	30.6578	19.0375	-132.19
0.72	31.0295	19.617	-134.586
0.736	30.8944	20.6096	-138.032
0.752	31.1849	21.6094	-141.17
0.768	32.63	22.9123	-142.815
0.784	32.7697	24.2011	-146.285
0.8	32.7747	25.4664	-149.395
0.816	33.8244	25.8476	-152.359
0.832	34.3352	26.9607	-155.432

Gumdrop
I Cont

time	pos(x)	pos(y)	pos(z)
0.848	34.7905	28.5104	-159.23
0.864	35.52	29.4568	-161.956
0.88	35.9443	30.8961	-165.987
0.896	36.8329	33.1911	-169.459
0.912	36.9822	33.6325	-173.335
0.928	36.5462	34.7324	-176.168
0.944	37.8191	35.5857	-179.437
0.96	38.3179	35.4785	-183.564
0.976	38.6627	36.5432	-187.573
0.992	38.21	37.5573	-190.63
1.008	38.415	37.2104	-194.805
1.024	38.155	37.987	-198.298
1.04	37.9484	38.0286	-201.487
1.056	37.4983	38.0949	-205.149
1.072	37.9283	37.5828	-208.113
1.088	36.0943	38.1032	-212.347
1.104	35.9917	37.5428	-215.137
1.12	36.7686	37.4438	-218.434
1.136	35.472	37.0182	-221.965
1.152	34.877	36.3133	-225.609
1.168	35.6557	35.3056	-227.236
1.184	35.3128	34.795	-230.427
1.2	34.8817	34.645	-233.466
1.216	34.8944	33.3648	-236.257
1.232	34.3563	33.1394	-238.894
1.248	33.9777	33.3787	-241.457
1.264	33.3526	32.6232	-244.494
1.28	33.0788	31.2726	-246.935
1.296	33.7401	32.3865	-250.201
1.312	33.261	31.8318	-252.91
1.328	32.2097	31.5847	-255.315
1.344	31.6698	29.0525	-258.165
1.36	30.0453	28.1549	-259.869
1.376	28.6086	26.8744	-262.778
1.392	28.215	26.3828	-264.484
1.408	25.8167	24.9395	-266.264
1.424	23.3584	24.238	-268.319
1.44	23.7023	23.2397	-269.453
1.456	25.0463	23.5441	-271.689
1.472	23.9808	23.326	-273.854
1.488	22.5243	22.5542	-275.747
1.504	22.6847	21.9246	-279.064
1.52	21.7891	23.0879	-282.769
1.536	22.1624	23.1151	-284.724

Gumdrop
1 Cont

time	pos(x)	pos(y)	pos(z)
1.552	22.0759	22.1298	-287.365
1.568	20.9647	21.4594	-289.95
1.584	20.1758	18.8643	-291.639
1.6	20.4678	18.2613	-294.169
1.616	19.5707	17.2359	-296.344

Gumdrop
2 v1= 4.314

time	pos(x)	pos(y)	pos(z)
0	0	0	0
0.016	1.1599	-2.42	-8.9222
0.032	0.078	-2.0733	-13.807
0.048	-0.0148	-2.0912	-18.5318
0.064	-0.4354	-1.2894	-21.3954
0.08	-0.2243	-2.2299	-26.9694
0.096	-1.9907	-1.1413	-29.0014
0.112	-2.2176	-0.4884	-32.4678
0.128	-2.2414	-1.2457	-37.2901
0.144	-3.1306	-1.1466	-40.3085
0.16	-2.8548	-0.7485	-43.1688
0.176	-3.3283	-0.6337	-45.7156
0.192	-3.1326	-1.1882	-49.8008
0.208	-5.1011	-0.6059	-52.777
0.224	-5.0871	-0.4302	-54.4342
0.24	-4.9757	-0.5482	-57.6194
0.256	-5.2588	-0.5848	-59.8695
0.272	-4.5781	-1.6017	-63.2929
0.288	-4.7041	-1.4501	-66.6713
0.304	-5.2999	-1.7098	-68.4933
0.32	-4.3817	-1.8704	-70.8488
0.336	-3.4208	-2.332	-72.9977
0.352	-4.0448	-2.267	-75.5951
0.368	-3.7181	-3.6544	-78.8722
0.384	-3.1965	-4.2606	-81.0781
0.4	-3.0842	-3.7956	-83.2667
0.416	-3.1625	-4.1768	-85.5317
0.432	-1.9961	-5.0085	-87.6221
0.448	-2.3683	-4.6509	-89.7622
0.464	-1.2821	-4.986	-91.478
0.48	-1.9589	-4.9509	-93.1343
0.496	-3.7407	-5.7164	-94.7197
0.512	-3.067	-5.8955	-96.8502
0.528	-3.1182	-6.1174	-99.6679
0.544	-3.1886	-6.3396	-101.397
0.56	-4.1747	-6.9094	-103.825

Gumdrop
2 Cont

time	pos(x)	pos(y)	pos(z)
0.576	-4.4115	-7.5143	-106.04
0.592	-3.65	-8.3088	-108.332
0.608	-2.7188	-8.3571	-110.794
0.624	-1.7506	-9.8683	-113.185
0.64	-1.3284	-10.0942	-115.223
0.656	-1.3395	-10.0881	-117.307
0.672	-0.8883	-11.8758	-119.711
0.688	-0.6629	-12.2295	-121.599
0.704	0.0244	-12.796	-124.222
0.72	-0.8703	-13.2239	-126.24
0.736	-0.0442	-14.3487	-127.916
0.752	-0.0829	-14.2572	-130.586
0.768	0.5169	-15.0804	-132.787
0.784	1.0052	-15.5417	-134.858
0.8	1.2185	-15.8877	-136.185
0.816	1.3242	-16.6579	-138.044
0.832	2.0077	-17.3515	-140.782
0.848	2.1026	-19.1521	-143.111
0.864	2.1326	-19.1059	-145.669
0.88	2.2781	-19.4299	-147.728
0.896	1.9195	-19.7754	-149.548
0.912	2.2117	-20.5447	-151.61
0.928	2.0906	-20.74	-154.612
0.944	1.9636	-21.8499	-156.434
0.96	1.4098	-21.7596	-158.295
0.976	1.314	-22.1028	-159.981
0.992	1.3224	-22.9939	-162.909
1.008	0.614	-22.8202	-164.661
1.024	0.4522	-23.4549	-166.386
1.04	0.8355	-24.1377	-169.095
1.056	-1.239	-23.9873	-170.411
1.072	-2.5693	-24.2237	-171.175
1.088	-0.8287	-25.2108	-173.426
1.104	-1.0803	-25.2892	-175.943
1.12	-1.2045	-25.337	-177.386
1.136	-0.6737	-26.0206	-178.966
1.152	-0.8232	-25.9261	-180.865
1.168	-2.1115	-25.5641	-183.536
1.184	-2.1139	-25.5874	-185.157
1.2	-1.3777	-25.9338	-186.577
1.216	-1.4199	-25.7639	-188.057
1.232	-1.3187	-25.7172	-191.274
1.248	-1.107	-26.8408	-192.767
1.264	-1.1918	-26.4676	-194.5

Gumdrop
2 Cont

time	pos(x)	pos(y)	pos(z)
1.28	-1.8335	-25.9865	-195.843
1.296	-2.4594	-25.7505	-198.225
1.312	-2.498	-25.5964	-199.808
1.328	-3.2344	-25.4125	-201.119
1.344	-3.6012	-25.1107	-203.44
1.36	-3.7172	-24.6847	-205.027
1.376	-4.3783	-25.9996	-206.503
1.392	-5.0661	-25.4732	-207.767
1.408	-6.2013	-24.3147	-208.81
1.424	-6.5439	-23.6528	-211.227
1.44	-6.0096	-24.2763	-212.688
1.456	-7.3177	-23.6312	-214.256
1.472	-7.8299	-23.4253	-215.966
1.488	-7.6588	-24.5669	-217.142
1.504	-8.9265	-24.5185	-219.078
1.52	-8.5047	-23.5151	-220.581
1.536	-9.4198	-23.1052	-222.507
1.552	-9.6411	-22.8834	-223.76
1.568	-10.8836	-23.0406	-225.062
1.584	-11.2664	-22.4306	-226.68
1.6	-11.1729	-22.7201	-227.94
1.616	-11.7664	-21.9064	-229.627
1.632	-12.3663	-21.4502	-231.328
1.648	-11.5539	-21.7864	-233.575
1.664	-12.3044	-21.4256	-234.995
1.68	-12.3447	-21.3257	-237.02
1.696	-12.8187	-21.3695	-238.044
1.712	-15.4059	-19.9505	-239.901
1.728	-14.2545	-19.9298	-242.233
1.744	-15.5823	-19.8713	-244.136
1.76	-15.6428	-19.4492	-245.797
1.776	-15.6616	-19.9757	-247.963
1.792	-15.7194	-19.8598	-250.331
1.808	-16.5393	-18.4234	-252.2
1.824	-17.1036	-17.5213	-255.311
1.84	-16.7871	-18.2171	-257.753
1.856	-16.939	-17.8567	-259.847
1.872	-18.351	-18.2164	-261.408
1.888	-18.0721	-17.7355	-264.099
1.904	-19.2603	-16.8706	-266.46
1.92	-18.3485	-17.5855	-267.898
1.936	-18.774	-17.405	-270.061
1.952	-18.0269	-18.2032	-271.008
1.968	-18.0667	-17.3176	-273.549

Gumdrop
3 v1= 3.979

time	pos(x)	pos(y)	pos(z)
0	0	0	0
0.016	0.4571	-0.4265	-6.3988
0.032	-0.3031	-0.742	-12.7337
0.048	-1.616	-0.8405	-16.9558
0.064	-1.1667	-0.5039	-21.849
0.08	-0.495	-0.3469	-25.7102
0.096	-1.2769	-0.0688	-29.1015
0.112	-1.5994	0.7513	-31.7259
0.128	-1.6847	0.8175	-35.7084
0.144	-0.6845	1.3953	-38.0051
0.16	-1.396	0.9508	-41.311
0.176	-1.0063	0.6394	-45.1709
0.192	-1.3853	1.0668	-47.2175
0.208	-1.6888	0.4926	-50.4492
0.224	-1.4442	0.0937	-53.5714
0.24	-1.3143	0.3131	-56.5224
0.256	-0.6637	0.197	-59.3642
0.272	-0.1259	0.6183	-62.4704
0.288	0.937	0.0007	-65.2307
0.304	1.0791	-0.241	-67.5173
0.32	0.4769	-0.0091	-69.9371
0.336	2.5022	0.5789	-71.3284
0.352	2.7791	-0.392	-74.4257
0.368	3.7263	-1.0958	-76.745
0.384	4.2478	-0.7681	-79.127
0.4	4.5995	-0.8305	-81.5867
0.416	5.507	-1.7825	-84.8644
0.432	6.318	-1.9159	-86.9927
0.448	6.3943	-2.0707	-89.8204
0.464	7.061	-2.0344	-92.1346
0.48	7.6663	-1.7813	-93.9677
0.496	8.0583	-2.2725	-97.2751
0.512	8.2658	-2.1616	-99.0317
0.528	8.836	-2.3874	-100.87
0.544	9.0928	-2.7629	-103.081
0.56	9.7801	-3.0471	-105.462
0.576	10.5093	-3.0632	-107.382
0.592	10.3649	-3.0069	-109.343
0.608	10.5642	-3.4109	-112.496
0.624	11.3204	-4.7318	-115.163
0.64	11.4214	-5.5232	-117.325
0.656	12.6474	-5.2137	-120.454
0.672	13.08	-5.4001	-121.649
0.688	14.7077	-6.503	-124.123

Gumdrop
3 Cont

time	pos(x)	pos(y)	pos(z)
0.704	14.6681	-6.8985	-127.264
0.72	15.8705	-7.0675	-129.236
0.736	16.6512	-7.4551	-131.13
0.752	17.5969	-8.0174	-133.711
0.768	17.4018	-8.2203	-135.787
0.784	18.666	-9.2826	-138.041
0.8	18.6747	-10.296	-140.132
0.816	19.675	-10.34	-142.559
0.832	20.4867	-9.9027	-144.204
0.848	21.4073	-10.759	-146.38
0.864	21.5866	-11.9406	-149.679
0.88	22.3053	-12.4018	-152.218
0.896	22.9553	-12.3615	-154.305
0.912	23.7275	-12.5438	-156.708
0.928	24.1212	-13.0913	-158.77
0.944	23.52	-12.5821	-161.848
0.96	24.5161	-12.3003	-163.945
0.976	24.8629	-12.3046	-165.932
0.992	24.5056	-12.5632	-168.146
1.008	25.2255	-12.3687	-170.706
1.024	25.3907	-12.4664	-173.063
1.04	25.2911	-12.1947	-175.029
1.056	25.5368	-12.5727	-176.721
1.072	25.8943	-12.4988	-179.414
1.088	26.4038	-12.4463	-181.855
1.104	26.3049	-12.2381	-183.983
1.12	26.8565	-11.2892	-186.233
1.136	26.3349	-12.2315	-188.154
1.152	27.7645	-12.3323	-190.279
1.168	28.0876	-12.375	-192.46
1.184	28.6505	-12.0878	-194.772
1.2	28.3644	-12.7003	-197.69
1.216	28.1891	-12.7897	-199.611
1.232	28.44	-12.4479	-201.102
1.248	28.0524	-12.1272	-204.321
1.264	28.4587	-11.8391	-206.254
1.28	27.934	-11.4205	-208.097
1.296	27.6712	-11.3336	-210.707
1.312	28.4859	-10.6845	-213.405
1.328	27.9614	-10.1146	-215.56
1.344	27.5416	-9.8022	-217.386
1.36	27.6388	-9.5217	-220.386
1.376	27.4548	-8.8902	-222.767
1.392	26.4619	-8.7587	-224.043

Gumdrop
3 Cont

time	pos(x)	pos(y)	pos(z)
1.408	26.1	-8.2829	-227.409
1.424	25.7846	-8.2	-228.943
1.44	25.4343	-8.2099	-230.284
1.456	25.3956	-6.7586	-233.451
1.472	25.2053	-6.9657	-235.201
1.488	24.655	-7.1521	-237.456
1.504	23.5418	-7.7019	-239.397
1.52	23.3115	-7.1706	-241.661
1.536	22.6823	-6.8411	-243.986
1.552	22.2426	-6.2684	-246.318
1.568	21.6628	-6.5944	-248.546
1.584	20.3554	-6.17	-251.383
1.6	19.9957	-6.4212	-253.721
1.616	20.0541	-6.0256	-256.606
1.632	20.6069	-6.0095	-259.041
1.648	20.1399	-6.4233	-260.87
1.664	19.1007	-6.3547	-264.244
1.68	19.9218	-6.8941	-266.045
1.696	19.0113	-5.7896	-268.624
1.712	19.158	-7.1969	-270.735
1.728	18.3896	-7.5052	-273.461
1.744	19.1882	-7.9452	-276.508
1.76	19.1866	-7.6321	-278.953
1.776	18.6365	-7.8169	-280.736

Gumdrop

time	pos(x)	pos(y)	pos(z)
0	0	0	0
0.016	0.6702	-0.218	-5.7322
0.032	0.7365	0.1764	-10.4503
0.048	0.9888	0.0033	-15.7432
0.064	0.2835	0.6355	-19.9608
0.08	0.3296	1.1185	-24.1106
0.096	0.7897	1.2731	-28.0863
0.112	0.7293	1.2607	-32.8895
0.128	0.6269	1.9194	-35.5965
0.144	0.4021	2.1304	-38.6018
0.16	0.2047	1.9854	-42.3951
0.176	-0.4393	2.5099	-44.8105
0.192	-0.5301	2.8437	-48.5731
0.208	-0.4251	2.5188	-52.1684
0.224	-0.2528	2.6074	-55.3382
0.24	-0.3984	3.1759	-58.0806
0.256	-0.438	3.7802	-60.3912

Gumdrop
4 Cont

time	pos(x)	pos(y)	pos(z)
0.272	-0.9966	3.9011	-62.9152
0.288	-0.8167	4.2021	-66.3583
0.304	-1.243	5.374	-68.484
0.32	-1.3897	5.8635	-70.5418
0.336	-2.536	6.5383	-72.9877
0.352	-3.0313	6.9023	-75.1793
0.368	-3.6713	7.3208	-78.4671
0.384	-5.38	7.2853	-81.7052
0.4	-5.6289	7.4813	-84.2143
0.416	-5.876	7.7633	-87.1614
0.432	-6.2232	6.5942	-90.2234
0.448	-6.2187	7.4352	-92.7433
0.464	-6.229	7.049	-96.4813
0.48	-6.8926	7.1991	-99.4149
0.496	-7.0274	7.0178	-101.937
0.512	-7.6569	6.8613	-105.478
0.528	-8.6021	6.7387	-108.249
0.544	-8.59	7.3999	-112.088
0.56	-9.2026	7.2809	-114.689
0.576	-8.9517	6.7812	-117.24
0.592	-10.1853	7.2887	-121.069
0.608	-11.1674	8.1161	-123.878
0.624	-12.7893	8.9363	-127.59
0.64	-12.8659	9.4432	-129.687
0.656	-12.1252	8.8327	-133.526
0.672	-12.3358	10.59	-136.144
0.688	-13.303	12.3021	-138.23
0.704	-14.067	12.9894	-141.16
0.72	-14.6079	13.4257	-144.071
0.736	-15.9305	14.8973	-146.287
0.752	-16.5973	15.7152	-148.094
0.768	-16.887	16.7446	-150.706
0.784	-16.5161	17.8187	-153.944
0.8	-17.4652	19.1973	-155.294
0.816	-18.9458	19.7565	-159.103
0.832	-18.0612	19.459	-162.307
0.848	-18.2207	20.1422	-164.826
0.864	-18.816	19.8633	-166.279
0.88	-18.3298	19.5026	-169.765
0.896	-18.5412	21.2493	-172.862
0.912	-20.3714	22.3281	-175.212
0.928	-20.9999	22.0094	-178.465
0.944	-20.7293	22.6751	-181.142
0.96	-21.4991	23.9024	-183.927

Gumdrop
4 Cont

time	pos(x)	pos(y)	pos(z)
0.976	-21.3727	25.204	-187.129
0.992	-23.0725	25.4979	-190.11
1.008	-25.1258	27.8816	-193.455
1.024	-25.929	27.4598	-196.407
1.04	-27.292	28.8608	-197.777
1.056	-28.7826	29.819	-201.169
1.072	-28.9746	29.6899	-204.202
1.088	-30.4144	32.1208	-207.167
1.104	-32.4963	33.2953	-209.361
1.12	-32.7747	34.214	-213.232
1.136	-33.5347	35.151	-215.701
1.152	-34.0178	35.2503	-217.858
1.168	-36.6382	35.8644	-221.584
1.184	-36.1479	36.0818	-224.554
1.2	-37.9403	38.6317	-227.459
1.216	-38.8741	39.0536	-230.548
1.232	-41.3706	39.4604	-232.049
1.248	-42.6403	39.813	-235.012
1.264	-43.3697	41.7499	-238.463
1.28	-43.8405	41.1275	-240.312
1.296	-43.8545	40.6091	-242.006
1.312	-45.5965	41.6101	-245.055
1.328	-45.8499	41.9318	-247.63
1.344	-46.9077	42.0533	-250.212
1.36	-48.2944	42.5485	-252.273
1.376	-49.5934	43.7272	-254.743
1.392	-49.8559	43.5007	-256.983
1.408	-51.8094	44.31	-259.765
1.424	-50.536	44.8753	-261.941
1.44	-53.3297	45.7448	-263.966
1.456	-54.849	46.312	-265.453
1.472	-54.8728	46.4714	-267.837
1.488	-56.5783	46.8322	-269.522
1.504	-59.5632	46.7364	-270.788
1.52	-59.7934	46.8721	-272.487
1.536	-61.8335	47.727	-275.028
1.552	-62.0158	48.1092	-277.236
1.568	-63.0891	47.7422	-278.443
1.584	-64.4347	47.9515	-281.327
1.6	-64.3429	47.9696	-282.126
1.616	-63.6022	48.3438	-284.624
1.632	-66.2406	49.0743	-286.17
1.648	-66.9896	48.411	-288.077
1.664	-67.6925	48.4282	-289.745

Gumdrop
4 Cont

time	pos(x)	pos(y)	pos(z)
1.68	-67.1681	47.3542	-291.768
1.696	-65.961	45.9844	-293.368
1.712	-66.958	45.9502	-295.218
1.728	-68.5106	46.4465	-297.094
1.744	-70.2601	46.7409	-299.263
1.76	-69.7619	45.0434	-301.386
1.776	-70.6519	44.8716	-303.706
1.792	-70.9441	44.2229	-306.055
1.808	-71.7001	44.3306	-308.258
1.824	-72.1873	43.0878	-310.064
1.84	-71.825	43.0659	-312.692

Gumdrop
5 v1= 3.871

time	pos(x)	pos(y)	pos(z)
0	0	0	0
0.016	0.4635	-0.6039	-6.5572
0.032	0.3755	-0.3728	-12.3863
0.048	0.4246	-0.9792	-18.4969
0.064	0.2405	-0.5626	-22.934
0.08	-0.0913	-0.2358	-26.9636
0.096	-1.1238	-0.263	-31.89
0.112	-1.7909	-0.2957	-35.1116
0.128	-2.1856	0.1187	-38.9609
0.144	-2.3621	0.1213	-42.4342
0.16	-1.7696	0.4232	-45.3161
0.176	-2.4043	0.1271	-48.3329
0.192	-2.9863	1.0328	-48.9976
0.208	-2.6765	0.7982	-52.9734
0.224	-3.6708	1.283	-56.5218
0.24	-4.9692	0.7931	-59.4008
0.256	-4.9974	0.3659	-62.608
0.272	-6.3473	0.9536	-64.8742
0.288	-7.6177	1.2317	-67.2724
0.304	-8.4143	2.2477	-69.6994
0.32	-9.0975	1.3796	-72.5497
0.336	-11.2384	1.8593	-74.8356
0.352	-12.167	2.2084	-76.8265
0.368	-12.2767	1.7509	-79.6226
0.384	-14.331	2.6755	-82.2736
0.4	-14.0761	2.2926	-84.0349
0.416	-15.4273	2.5451	-86.551
0.432	-14.03	1.9993	-88.9674
0.448	-14.2644	2.2578	-91.9643
0.464	-14.5426	1.7309	-94.5052

Gumdrop
5 Cont

time	pos(x)	pos(y)	pos(z)
0.48	-14.5344	2.2822	-96.4567
0.496	-14.4371	2.8197	-99.2813
0.512	-15.1835	2.3455	-102.518
0.528	-15.1723	2.0488	-105.417
0.544	-15.7698	2.3995	-107.878
0.56	-15.7532	2.9152	-110.193
0.576	-15.7832	2.1841	-114.206
0.592	-16.1602	2.7247	-116.339
0.608	-15.8135	2.4807	-119.325
0.624	-17.0462	2.5343	-122.6
0.64	-16.6383	2.6545	-125.753
0.656	-16.799	2.6336	-128.601
0.672	-16.9858	2.9181	-130.862
0.688	-18.3966	3.585	-133.54
0.704	-19.3894	4.2331	-136.705
0.72	-19.9428	4.8955	-139.435
0.736	-20.6553	4.5347	-141.814
0.752	-21.1422	4.95	-144.677
0.768	-22.4117	5.7975	-147.896
0.784	-23.3253	6.1288	-150.072
0.8	-24.0016	6.4543	-152.659
0.816	-26.2627	6.703	-154.664
0.832	-26.1247	6.1786	-157.687
0.848	-27.4081	7.1421	-159.441
0.864	-27.8953	7.1947	-162.201
0.88	-27.733	7.8375	-163.926
0.896	-28.766	8.4895	-166.954
0.912	-29.6573	8.694	-168.736
0.928	-30.6252	9.0823	-171.216
0.944	-32.2509	9.0756	-173.023
0.96	-31.2752	9.0829	-175.044
0.976	-31.7459	9.1929	-177.465
0.992	-31.8413	8.8342	-180.404
1.008	-33.9146	9.966	-182.618
1.024	-34.1573	10.0044	-184.962
1.04	-35.6322	11.1016	-188.27
1.056	-36.4324	11.9918	-190.142
1.072	-36.8578	12.4495	-192.426
1.088	-36.85	12.3887	-194.814
1.104	-38.8209	13.5959	-196.353
1.12	-38.9122	13.7851	-199.143
1.136	-39.3069	15.1439	-201.551
1.152	-41.692	16.1806	-204.101
1.168	-42.5187	17.471	-206.663

Gumdrop
5 Cont

time	pos(x)	pos(y)	pos(z)
1.184	-40.9049	16.4021	-208.089
1.2	-42.1383	17.6993	-209.845
1.216	-46.8696	19.7946	-211.964
1.232	-46.6012	19.759	-214.813
1.248	-48.787	20.0876	-216.723
1.264	-48.0965	20.1629	-220.154
1.28	-47.9822	19.025	-221.93
1.296	-49.706	20.6898	-224.423
1.312	-49.9524	20.8868	-226.924
1.328	-50.7094	21.7851	-229.82
1.344	-53.12	22.4972	-232.009
1.36	-54.3714	23.3	-235.364
1.376	-55.5933	24.7626	-237.622
1.392	-54.8241	23.7312	-239.721
1.408	-55.6948	24.2706	-242.25
1.424	-56.4071	24.734	-244.743
1.44	-58.2797	25.6848	-247.309
1.456	-57.6765	24.6074	-248.932
1.472	-58.6898	25.1663	-251.028
1.488	-58.6259	24.8731	-252.699
1.504	-60.0903	25.8252	-254.714
1.52	-61.75	26.1564	-256.758
1.536	-62.6048	25.0105	-258.969
1.552	-62.6622	24.8774	-261.123
1.568	-63.2082	24.6411	-263.449
1.584	-64.1941	24.144	-265.719
1.6	-64.6475	23.6937	-266.579
1.616	-65.0476	23.8343	-270.305
1.632	-67.0717	23.2468	-272.441
1.648	-69.5392	23.8855	-275.261
1.664	-69.2945	22.8432	-276.1
1.68	-69.6209	22.7221	-278.579
1.696	-71.6842	22.9186	-281.431
1.712	-71.7411	22.0916	-283.719
1.728	-74.0092	23.0747	-286.493
1.744	-72.9828	20.9424	-288.399
1.76	-73.3091	20.7343	-291.394
1.776	-72.7854	19.476	-292.604
1.792	-73.9983	19.3793	-294.958
1.808	-74.6924	18.3986	-296.764
1.824	-73.971	17.4307	-298.513

Gumdrop

6	v1= 2.603		
time	pos(x)	pos(y)	pos(z)
0.016	1.6977	0.1326	-4.2642
0.032	2.8454	0.3662	-8.3297
0.048	3.4454	1.5052	-11.0345
0.064	3.8246	1.9621	-15.2187
0.08	3.9063	2.6052	-19.3143
0.096	4.911	2.3451	-23.8032
0.112	4.9682	2.7901	-27.2429
0.128	5.345	3.3498	-30.8954
0.144	5.6037	4.3744	-34.4365
0.16	6.3594	5.5475	-37.0634
0.176	6.3443	5.7279	-40.8085
0.192	5.7107	6.3977	-43.3801
0.208	6.5337	6.3789	-47.1377
0.224	6.2405	6.7233	-49.3979
0.24	6.396	6.0805	-54.8507
0.256	5.5993	6.1143	-57.0096
0.272	6.3405	6.8657	-60.2442
0.288	6.0513	6.8719	-63.9972
0.304	6.0704	6.6526	-66.9496
0.32	5.917	7.6021	-69.731
0.336	5.9978	6.9141	-72.4994
0.352	6.8126	5.4427	-76.6422
0.368	7.1134	6.0917	-79.5054
0.384	6.8117	5.8934	-81.9006
0.4	6.5256	5.3642	-84.8231
0.416	5.3037	6.0437	-87.9089
0.432	5.0206	6.6112	-90.705
0.448	5.3206	6.0972	-92.6967
0.464	6.4442	5.955	-95.3819
0.48	6.2697	5.4933	-98.1472
0.496	7.5206	5.5445	-100.927
0.512	6.8414	5.1139	-103.261
0.528	7.3462	5.1538	-105.776
0.544	8.3527	4.0605	-109.417
0.56	7.671	4.5184	-111.988
0.576	7.1297	4.7883	-114.683
0.592	6.7793	4.4622	-117.073
0.608	6.5746	3.9601	-119.914
0.624	5.6359	3.9275	-122.36
0.64	5.9302	2.9062	-125.457
0.656	4.503	2.4396	-127.836
0.672	4.2813	2.3609	-130.68
0.688	4.3681	1.5539	-133.39
0.704	3.5092	-0.7526	-136.549

Gumdrop
6 Cont

time	pos(x)	pos(y)	pos(z)
0.72	2.3687	-1.6846	-138.888
0.736	2.8815	-1.6259	-141.523
0.752	2.3479	-2.4149	-144.356
0.768	1.6685	-2.3481	-146.668
0.784	0.8182	-2.5037	-149.5
0.8	0.3011	-4.4491	-152.129
0.816	1.6877	-5.4307	-155.457
0.832	2.8871	-6.4776	-157.852
0.848	0.7786	-6.8093	-160.698
0.864	0.3157	-7.6965	-162.544
0.88	-0.0853	-7.981	-166.057
0.896	-0.9317	-8.302	-168.398
0.912	-3.1493	-8.5922	-170.403
0.928	-3.1879	-9.1654	-173.079
0.944	-3.7767	-9.9053	-175.734
0.96	-4.7351	-10.8309	-178.288
0.976	-6.6623	-12.0007	-179.861
0.992	-8.0612	-12.0803	-182.435
1.008	-7.5998	-14.3118	-185.11
1.024	-8.7079	-14.8396	-186.902
1.04	-8.6405	-15.8683	-188.888
1.056	-9.5156	-16.7533	-191.155
1.072	-9.9792	-17.8944	-193.019
1.088	-10.8384	-18.6056	-194.29
1.104	-10.4754	-20.451	-196.101
1.12	-10.7936	-20.9182	-197.918
1.136	-11.1819	-22.4123	-200.027
1.152	-11.0243	-23.8815	-201.76
1.168	-10.3143	-25.7543	-203.02
1.184	-10.4951	-25.7179	-205.356
1.2	-11.3094	-26.0926	-206.733
1.216	-11.6316	-27.8784	-208.917
1.232	-10.8129	-27.8346	-210.32
1.248	-11.2684	-29.5893	-212.145
1.264	-11.1882	-30.3275	-214.532
1.28	-11.8007	-30.8129	-216.357
1.296	-12.0989	-31.1937	-218.721
1.312	-11.3594	-33.3171	-220.565
1.328	-11.9956	-33.545	-222.681
1.344	-10.6808	-34.063	-224.787
1.36	-10.7537	-35.0092	-227.239
1.376	-11.0586	-35.6319	-229.493
1.392	-10.5965	-35.8448	-232.032
1.408	-10.0039	-37.5023	-233.219

Gumdrop
6 Cont

time	pos(x)	pos(y)	pos(z)
1.424	-9.9937	-37.8003	-236.225
1.44	-10.2288	-39.1908	-239.389
1.456	-9.6801	-39.264	-241.431
1.472	-9.4898	-39.929	-243.837
1.488	-8.8537	-39.5867	-246.382
1.504	-8.8837	-39.5191	-249.902
1.52	-8.9262	-38.4675	-253.342
1.536	-7.9284	-40.5123	-254.602
1.552	-7.6918	-40.2421	-257.355
1.568	-7.7409	-41.2967	-260.722
1.584	-7.4447	-41.417	-263.907
1.6	-6.7296	-42.078	-266.291
1.616	-6.5278	-41.6302	-269.68
1.632	-6.2088	-41.4588	-272.946
1.648	-6.1128	-41.8415	-276.025

Gumdrop

time	pos(x)	pos(y)	pos(z)
0	0	0	0
0.016	1.679	1.1361	-2.8174
0.032	2.4335	0.6555	-8.2019
0.048	2.4316	1.664	-11.9614
0.064	3.4502	1.0659	-16.38
0.08	4.7998	2.9107	-18.9986
0.096	5.4276	3.0192	-23.4837
0.112	5.6925	3.9044	-26.8427
0.128	5.8422	4.4979	-29.7432
0.144	6.5631	5.2317	-33.2827
0.16	7.1892	4.9992	-36.7221
0.176	8.0957	6.0642	-40.0493
0.192	9.0325	6.0183	-43.3679
0.208	8.1056	6.9101	-44.6955
0.224	6.03	7.4294	-49.6237
0.24	4.4248	8.4963	-52.2425
0.256	3.7491	8.3122	-54.5721
0.272	3.5377	8.7696	-57.8639
0.288	4.5425	9.6771	-60.8745
0.304	3.9967	9.0674	-63.9524
0.32	2.8081	10.7907	-67.0837
0.336	1.0748	10.1572	-69.7057
0.352	1.7757	9.8871	-72.4429
0.368	-0.027	11.3902	-75.2075
0.384	0.9136	11.2356	-77.0088
0.4	0.6436	11.205	-79.5507

Gumdrop
7 Cont

time	pos(x)	pos(y)	pos(z)
0.416	0.1866	11.6455	-82.1618
0.432	0.7168	13.0112	-83.8461
0.448	-0.8763	13.1957	-86.6219
0.464	-0.7212	14.2724	-88.4904
0.48	-1.3077	15.2751	-91.227
0.496	-0.3913	16.2429	-92.5725
0.512	-0.3801	15.9547	-96.0677
0.528	-0.4953	16.5792	-97.3772
0.544	-1.8247	17.9903	-99.9474
0.56	-1.1337	18.3566	-102.182
0.576	-0.6548	18.4454	-104.894
0.592	0.1624	18.6165	-107.757
0.608	0.419	18.7872	-110.323
0.624	0.5544	19.4607	-112.988
0.64	-0.2982	20.2203	-116.446
0.656	-1.0898	22.2615	-118.559
0.672	-1.929	22.3093	-121.372
0.688	-2.7344	22.6604	-124.066
0.704	-3.671	24.2348	-126.947
0.72	-4.2322	24.551	-129.693
0.736	-4.4162	25.7661	-132.147
0.752	-6.1994	28.6421	-134.706
0.768	-7.3118	30.1277	-137.577
0.784	-8.7999	31.5154	-139.987
0.8	-11.0432	33.7436	-141.727
0.816	-11.3699	33.4739	-143.781
0.832	-12.0186	34.6564	-145.894
0.848	-13.0111	35.6845	-147.959
0.864	-11.425	36.515	-151.316
0.88	-10.9779	37.1021	-153.418
0.896	-11.6555	38.114	-155.939
0.912	-12.3599	38.8197	-158.875
0.928	-11.8649	39.644	-161.527
0.944	-12.5539	39.8858	-164.514
0.96	-13.2697	40.8413	-166.793
0.976	-14.1667	40.6306	-169.133
0.992	-19.2632	42.2264	-172.068
1.008	-20.0223	43.2673	-174.893
1.024	-20.9195	45.0516	-177.695
1.04	-21.6219	45.6263	-180.134
1.056	-23.2608	46.1154	-181.798
1.072	-23.3926	47.0458	-183.931
1.088	-25.1872	48.3492	-187.008
1.104	-26.5642	48.9534	-189.872

Gumdrop
7 Cont

time	pos(x)	pos(y)	pos(z)
1.12	-27.7706	50.4841	-191.595
1.136	-27.8761	51.084	-194.152
1.152	-28.3405	51.9248	-196.727
1.168	-29.3859	52.3508	-198.947
1.184	-29.348	52.1788	-201.402
1.2	-29.3941	52.3989	-203.435
1.216	-29.7191	52.5383	-206.591
1.232	-31.4469	53.1953	-209.022
1.248	-32.4283	53.407	-212.037
1.264	-32.8954	54.1715	-214.843
1.28	-33.5527	54.4334	-217.248
1.296	-33.2884	54.7322	-220.444
1.312	-34.0633	54.1054	-223.545
1.328	-34.8428	53.4138	-225.855
1.344	-35.2816	53.8922	-228.079
1.36	-34.7741	53.582	-231.03
1.376	-35.5457	52.957	-234.925
1.392	-36.0336	52.3294	-237.296
1.408	-35.4885	52.1022	-241.15
1.424	-35.1061	51.7189	-243.254
1.44	-36.5438	51.4154	-246.232
1.456	-36.4452	51.1533	-248.751
1.472	-36.105	49.8372	-250.712
1.488	-36.032	48.5503	-252.804
1.504	-37.1594	48.3009	-255.535
1.52	-37.0128	49.4348	-259.105
1.536	-35.2128	47.5973	-260.637
1.552	-35.1819	46.1345	-263.091
1.568	-34.4204	44.2401	-266.454
1.584	-34.6271	45.2534	-268.429
1.6	-35.8588	45.4555	-272.166
1.616	-35.0684	43.9224	-274.045
1.632	-34.8716	43.519	-276.411
1.648	-34.6311	42.5602	-278.651
1.664	-33.3026	41.8528	-280.562
1.68	-32.5582	38.4368	-283.483
1.696	-32.188	39.8146	-286.637
1.712	-32.2451	39.7964	-287.979
1.728	-30.4242	39.3379	-290.825
1.744	-30.3005	36.8939	-291.699
1.76	-28.5899	37.8423	-294.021
1.776	-28.3177	37.1299	-296.35
1.792	-26.1127	35.8377	-299.073
1.808	-26.1848	35.1621	-301.607

Gumdrop
7 Cont

time	pos(x)	pos(y)	pos(z)
1.824	-26.7475	34.2352	-303.502
1.84	-26.8958	34.0788	-304.881
1.856	-27.3632	32.6161	-306.482
1.872	-25.9692	30.6733	-309.074
1.888	-25.2992	30.4592	-310.28

Gumdrop
8 v1= 2.370

time	pos(x)	pos(y)	pos(z)
0	0	0	0
0.016	1.9072	0.948	-3.9262
0.032	2.6991	1.4895	-7.5847
0.048	3.0313	2.431	-11.3778
0.064	3.6679	2.7372	-15.6491
0.08	4.4346	4.3501	-18.6318
0.096	4.5219	4.1061	-22.582
0.112	3.8342	5.0033	-26.7714
0.128	5.4397	5.4503	-31.4654
0.144	5.6217	6.3583	-34.3371
0.16	6.1768	6.9766	-37.4659
0.176	6.7398	7.6507	-40.6761
0.192	7.1152	8.9905	-43.3242
0.208	7.3823	8.4519	-48.4724
0.224	6.8594	8.4597	-51.9607
0.24	6.314	9.7781	-55.4702
0.256	6.4255	9.658	-59.3871
0.272	5.8477	10.1956	-61.9364
0.288	4.9613	11.6412	-65.1603
0.304	3.7962	12.2076	-67.6685
0.32	3.864	12.1994	-71.8318
0.336	3.5484	13.2191	-74.6884
0.352	3.6736	14.188	-76.8298
0.368	3.1545	14.4208	-80.4244
0.384	2.4883	13.6068	-84.391
0.4	1.906	14.1497	-87.0071
0.416	0.4035	14.8363	-89.4004
0.432	-1.4019	16.6515	-92.3716
0.448	-1.9784	17.1971	-95.34
0.464	-2.5354	18.0722	-97.3526
0.48	-2.7244	18.7446	-100.119
0.496	-2.766	18.411	-103.733
0.512	-2.2976	19.5786	-105.935
0.528	-2.9989	20.3204	-108.73
0.544	-3.1472	21.4746	-112.787
0.56	-4.5843	22.8068	-115.59

Gumdrop
8 Cont

time	pos(x)	pos(y)	pos(z)
0.576	-5.4667	23.4093	-118.815
0.592	-6.917	23.7537	-121.297
0.608	-7.826	24.1196	-124.859
0.624	-8.652	25.738	-128.132
0.64	-11.0971	25.9941	-130.694
0.656	-10.8581	24.4333	-133.088
0.672	-13.1076	24.7335	-136.009
0.688	-14.0799	24.4944	-139.059
0.704	-16.9191	25.7665	-141.372
0.72	-17.3941	26.0509	-144.151
0.736	-17.734	26.6544	-146.011
0.752	-18.5184	28.0643	-148.999
0.768	-19.6422	27.8202	-151.41
0.784	-19.0197	26.284	-153.911
0.8	-20.5295	28.2718	-158.231
0.816	-20.2668	28.0902	-161.031
0.832	-22.8152	28.0877	-163.072
0.848	-23.5073	28.4567	-167.049
0.864	-25.598	28.7574	-169.834
0.88	-27.5192	29.8722	-171.988
0.896	-28.1609	30.2209	-175.315
0.912	-31.3637	30.1097	-178.309
0.928	-31.9545	30.1224	-180.601
0.944	-32.7093	29.5119	-182.874
0.96	-37.3349	31.2093	-186.488
0.976	-37.5107	30.5562	-189.236
0.992	-38.5466	31.186	-191.834
1.008	-38.8295	31.1041	-193.958
1.024	-40.7405	31.7309	-197.112
1.04	-43.6175	31.6298	-199.776
1.056	-44.9187	31.05	-202.2
1.072	-46.8156	31.5944	-203.998
1.088	-47.8235	32.0711	-206.202
1.104	-49.8378	31.2444	-211.419
1.12	-49.7479	31.7963	-213.17
1.136	-49.4694	29.9557	-216.41
1.152	-50.4749	29.6578	-219.701
1.168	-52.024	29.9518	-222.343
1.184	-52.5497	29.8705	-224.579
1.2	-53.1652	29.2176	-228.299
1.216	-54.1209	27.9475	-230.971
1.232	-55.3064	28.3197	-234.95
1.248	-55.4376	27.3263	-238.062
1.264	-56.0642	26.1286	-241.677

Gumdrop
8 Cont

time	pos(x)	pos(y)	pos(z)
1.28	-58.6774	25.1633	-244.906
1.296	-60.7822	25.3629	-248.101
1.312	-59.4046	23.7048	-251.299
1.328	-62.4931	23.0501	-254.945
1.344	-61.4391	21.3983	-258.85
1.36	-61.4598	20.5801	-262.266
1.376	-62.0254	19.5188	-265.608
1.392	-62.1728	18.2913	-268.687
1.408	-62.4554	17.9007	-272.786
1.424	-62.7682	16.8503	-275.443
1.44	-62.2584	14.3673	-278.53
1.456	-63.4118	14.8688	-281.973
1.472	-63.7107	14.002	-286.02
1.488	-63.3927	11.2584	-289.737
1.504	-64.894	11.3127	-292.156
1.52	-65.2152	10.619	-296.394
1.536	-65.5663	9.4972	-299.378
1.552	-66.8207	8.5527	-302.287
1.568	-67.6839	7.1424	-305.582
1.584	-70.1181	7.3983	-307.607

Gumdrop
9 v1= 2.206

time	pos(x)	pos(y)	pos(z)
0	0	0	0
0.016	0.8238	0.1489	-3.6939
0.032	1.2216	1.0861	-7.0609
0.048	1.9246	1.1922	-11.1664
0.064	2.6926	2.1083	-14.8756
0.08	3.2115	2.4062	-19.3339
0.096	3.7951	2.6884	-22.5579
0.112	3.6626	3.9864	-25.7215
0.128	3.8067	4.0261	-30.1861
0.144	4.3857	4.4298	-33.5004
0.16	4.5601	5.2242	-35.8882
0.176	4.1287	5.9396	-39.5579
0.192	5.4682	6.8612	-41.8708
0.208	5.7996	7.596	-45.209
0.224	5.1417	7.8854	-48.9716
0.24	5.9075	8.556	-52.0363
0.256	3.6685	8.6769	-55.4503
0.272	3.4268	9.4756	-58.1587
0.288	2.1923	10.3169	-61.8098
0.304	1.7109	9.965	-64.4747
0.32	0.8725	10.3492	-67.8804

Gumdrop
9 Cont

time	pos(x)	pos(y)	pos(z)
0.336	0.2688	11.3894	-70.8265
0.352	-1.7426	12.0229	-74.3996
0.368	-3.6003	11.8155	-77.5539
0.384	-4.8762	12.3229	-80.3013
0.4	-7.7126	13.8506	-83.0589
0.416	-9.5946	14.6868	-85.3329
0.432	-11.7007	15.2475	-88.114
0.448	-12.5358	14.9485	-90.4683
0.464	-14.1901	15.6655	-92.4141
0.48	-14.8388	16.35	-94.4119
0.496	-16.9249	17.4708	-96.6499
0.512	-17.2497	17.525	-98.6781
0.528	-19.8269	17.5448	-101.236
0.544	-21.3328	17.7499	-102.897
0.56	-21.7727	19.1151	-105.192
0.576	-21.3448	19.8441	-106.985
0.592	-21.8228	19.7348	-110.125
0.608	-24.5311	20.2551	-111.826
0.624	-26.2954	19.7736	-113.842
0.64	-27.735	21.1768	-114.849
0.656	-27.9915	21.7695	-117.218
0.672	-30.103	21.5728	-118.635
0.688	-33.3258	21.9996	-120.186
0.704	-33.9927	23.4358	-122.305
0.72	-36.4229	24.237	-123.672
0.736	-39.6349	24.5834	-125.865
0.752	-39.4888	25.6478	-128.21
0.768	-39.3652	25.1348	-130.185
0.784	-39.1463	25.0677	-133.362
0.8	-40.7705	25.6554	-134.564
0.816	-41.7059	25.9441	-136.716
0.832	-43.0174	27.1711	-139.658
0.848	-44.7214	27.135	-142.31
0.864	-46.6653	28.5557	-144.784
0.88	-49.7245	29.6156	-147.685
0.896	-51.8496	30.7278	-149.899
0.912	-53.7618	31.0687	-151.53
0.928	-54.3349	31.3365	-155.192
0.944	-57.4422	32.5554	-157.154
0.96	-57.5816	32.8415	-159.873
0.976	-57.3001	32.6922	-161.867
0.992	-59.0705	33.1324	-165.514
1.008	-61.2802	34.8957	-167.463
1.024	-61.913	35.6018	-169.998

Gumdrop
9 Cont

time	pos(x)	pos(y)	pos(z)
1.04	-62.8711	36.4234	-172.633
1.056	-63.992	36.107	-174.514
1.072	-64.8509	35.7388	-179.521
1.088	-67.8342	36.9723	-181.686
1.104	-68.1083	37.5029	-184.817
1.12	-67.7742	37.3285	-188.081
1.136	-67.7402	37.1749	-190.574
1.152	-72.3996	38.4312	-193.538
1.168	-73.5215	38.826	-196.89
1.184	-75.4886	39.6584	-200.095
1.2	-75.162	38.9288	-203.644
1.216	-76.8643	38.6552	-207.93
1.232	-79.044	39.9161	-211.347
1.248	-80.0449	40.0212	-214.742
1.264	-80.4083	40.1652	-218.416
1.28	-81.7871	39.84	-221.633
1.296	-83.4251	39.5651	-225.435
1.312	-82.5511	38.7043	-229.925
1.328	-82.6144	37.8336	-233.294
1.344	-85.0022	38.3185	-237.418
1.36	-85.144	38.0422	-240.415
1.376	-86.2319	38.4048	-244.171
1.392	-86.5438	37.4791	-248.087
1.408	-87.5557	37.3745	-252.327
1.424	-87.3297	36.7393	-256.325
1.44	-87.6512	36.1391	-260.141
1.456	-88.7461	35.1834	-262.272
1.472	-89.7013	34.3597	-265.307
1.488	-93.4303	33.3049	-268.551
1.504	-95.8196	35.5064	-271.012
1.52	-95.4484	34.1974	-273.968
1.536	-93.882	32.4821	-276.785
1.552	-96.9862	33.3647	-279.208
1.568	-94.3289	31.05	-281.466
1.584	-97.931	31.5727	-283.922
1.6	-98.0944	31.601	-286.546
1.616	-98.6622	30.491	-288.571
1.632	-100.314	31.4033	-291.624
1.648	-101.367	29.0891	-292.493
1.664	-101.631	29.1394	-295.3
1.68	-102.392	28.7201	-297.481
1.696	-102.047	28.3276	-300.923
1.712	-102.7	27.9273	-303.283
1.728	-103.809	28.1748	-305.897

Gumdrop
9 Cont

time	pos(x)	pos(y)	pos(z)
1.744	-104.411	28.2658	-307.849
1.76	-104.099	27.6348	-310.42
1.776	-107.88	28.5091	-312.015
1.792	-106.459	27.8241	-314.492
1.808	-107.865	29.6768	-317.815

Manta Data Table

Man1	v1 = 1.81										
time	pos(x)	pos(y)	pos(z)	el	az	x1	y1	z1	x2	y2	z2
0	0	0	0	0.479	-0.1577	-2.9893	0.4752	1.5721	2.9893	-0.4752	-1.5721
0.016	0.4059	1.0202	-2.6563	0.6047	-0.0673	-2.1732	1.1942	-0.8698	2.9851	0.8463	-4.4429
0.032	0.1208	1.6162	-5.8205	1.044	0.2437	-1.1879	1.2908	-3.502	1.4294	1.9417	-8.1389
0.048	0.3576	1.3555	-10.0499	1.182	0.428	-0.4517	0.9863	-7.8785	1.167	1.7246	-12.2212
0.064	1.7808	0.9834	-14.4355	1.544	2.1529	1.8143	0.9325	-12.1626	1.7473	1.0343	-16.7084
0.08	1.3133	1.1012	-17.4548	1.2762	2.3979	1.7464	0.7028	-15.5157	0.8803	1.4996	-19.3939
0.096	1.5884	1.3266	-19.7592	1.0483	2.7642	2.6397	0.9099	-17.7955	0.537	1.7434	-21.723
0.112	1.9197	1.2547	-22.0865	1.0981	2.9808	2.9993	1.0797	-19.9478	0.8401	1.4298	-24.2252
0.128	1.6404	1.277	-24.4879	0.9543	2.8453	2.9788	0.8684	-22.5133	0.3021	1.6857	-26.4624
0.144	1.2402	0.7763	-26.7915	0.9586	3.127	2.7439	0.7544	-24.6497	-0.2635	0.7983	-28.9332
0.16	2.0155	0.8529	-29.16	0.7809	2.9419	3.7643	0.4989	-27.3915	0.2666	1.2069	-30.9285
0.176	1.8618	0.1455	-31.1344	1.1793	2.8286	2.605	-0.0951	-29.2422	1.1187	0.386	-33.0267
0.192	2.1998	1.1045	-30.843	1.0156	2.8778	3.3997	0.7804	-28.8392	1	1.4285	-32.8467
0.208	3.635	1.4806	-31.6812	1.3255	1.7018	3.7	0.9874	-29.6941	3.57	1.9739	-33.6682
0.224	3.9626	0.9127	-32.664	1.3129	0.3271	3.3561	0.7069	-30.2355	4.5691	1.1185	-35.0925
0.24	4.7631	1.3485	-32.8692	1.2872	0.1805	3.9643	1.2027	-30.0828	5.562	1.4944	-35.6556
0.256	5.6972	1.2932	-33.463	1.0163	0.2237	4.1916	0.9507	-30.9696	7.2029	1.6358	-35.9564
0.272	6.1062	1.5499	-33.6017	1.0229	0.028	4.4799	1.5043	-30.9357	7.7325	1.5955	-36.2677
0.288	5.9894	1.643	-34.2081	0.6784	0.2797	3.6741	0.9779	-32.2663	8.3048	2.3081	-36.1499
0.304	7.1886	1.5446	-34.7307	0.6179	0.3324	4.9061	0.7567	-33.0144	9.4711	2.3326	-36.4469
0.32	7.8933	2.1203	-34.7568	0.7897	0.0666	5.9982	1.9938	-32.8411	9.7884	2.2468	-36.6726
0.336	9.0657	2.0734	-35.489	0.6498	0.0568	6.6985	1.9389	-33.6872	11.433	2.208	-37.2907
0.352	9.5323	1.7115	-35.3314	0.603	0.0328	7.4186	1.6422	-33.8752	11.6461	1.7808	-36.7876
0.368	9.789	2.2602	-35.5445	0.1426	0.475	7.8192	1.2471	-35.2266	11.7589	3.2733	-35.8625
0.384	10.3628	2.2526	-36.7775	0.458	0.1802	8.2967	1.8763	-35.7422	12.4289	2.629	-37.8128
0.4	10.0923	2.4557	-36.514	0.546	0.0756	8.091	2.304	-35.2944	12.0936	2.6073	-37.7335
0.416	10.4115	2.4389	-37.3751	0.4285	0.2865	8.4661	1.8658	-36.4487	12.3568	3.012	-38.3015
0.432	10.1208	2.0738	-37.9283	0.6556	-0.0539	8.4416	2.1643	-36.6351	11.7999	1.9832	-39.2215
0.448	10.4018	2.5069	-38.0984	0.4904	0.072	8.3692	2.3603	-37.0103	12.4344	2.6534	-39.1865
0.464	10.4888	2.6253	-38.5303	0.2654	0.242	8.2862	2.0817	-37.9135	12.6913	3.1689	-39.147
0.48	10.532	2.7325	-39.7583	0.7277	0.0566	8.795	2.6341	-38.2086	12.2689	2.8309	-41.308
0.496	10.3338	2.8024	-40.2287	0.6103	0.0778	8.2925	2.6432	-38.7968	12.3751	2.9617	-41.6606
0.512	10.3689	3.2262	-40.2995	0.3791	0.3003	8.4639	2.6364	-39.5049	12.2739	3.8161	-41.094
0.528	10.8383	2.0982	-42.4275	0.8485	0.18	9.3167	1.8213	-40.6721	12.3599	2.375	-44.1829
0.544	10.4664	1.0607	-43.7917	1.0778	-0.1846	8.8683	1.3591	-40.7654	12.0645	0.7623	-46.818
0.56	10.9364	1.3268	-44.5549	1.0951	-0.1956	9.4036	1.6305	-41.5216	12.4693	1.0232	-47.5881
0.576	9.824	1.3247	-46.0332	1.1308	-0.1745	8.4708	1.5632	-43.1143	11.1771	1.0862	-48.952
0.592	9.7479	1.5301	-46.9589	0.9985	-0.0025	8.0055	1.5344	-44.2539	11.4903	1.5258	-49.6639
0.608	8.5689	1.4009	-47.9348	1.4902	-0.0974	8.322	1.425	-44.863	8.8158	1.3767	-51.0066
0.624	7.9291	1.6059	-48.722	1.5112	-0.2106	7.7497	1.6442	-45.6476	8.1085	1.5675	-51.7964
0.64	7.8151	1.3844	-49.9644	1.5277	0.5034	7.7294	1.3372	-47.697	7.9009	1.4316	-52.2319
0.656	7.352	1.3314	-51.0827	1.5359	-2.3267	7.4198	1.4033	-48.2493	7.2842	1.2594	-53.9161
0.672	7.0072	1.5964	-51.3125	1.4752	2.9479	7.2412	1.5505	-48.8264	6.7731	1.6423	-53.7986
0.688	6.8904	1.1511	-52.4385	1.5201	-2.2699	6.9707	1.2465	-49.982	6.8102	1.0556	-54.895
0.704	6.4777	0.7676	-53.7965	1.4349	2.9541	6.8084	0.7049	-51.335	6.147	0.8304	-56.2581
0.72	5.5173	0.521	-54.9824	1.2321	-3.086	6.4939	0.5754	-52.2057	4.5408	0.4667	-57.759
0.736	6.1575	0.2387	-56.0767	1.2923	-2.6836	6.9055	0.6074	-53.1606	5.4095	-0.13	-58.9928
0.752	5.6825	-0.2704	-56.9294	1.2542	-2.9612	6.5452	-0.1131	-54.253	4.8198	-0.4277	-59.6058
0.768	5.5014	-0.6945	-58.351	1.1404	-3.0887	6.6031	-0.6362	-55.9481	4.3997	-0.7529	-60.7539
0.784	5.0637	-0.6426	-59.1987	1.3499	-2.618	5.5936	-0.3367	-56.474	4.5339	-0.9485	-61.9233
0.8	5.2812	-0.8696	-59.9213	1.2112	-2.9007	6.0686	-0.6762	-57.7645	4.4938	-1.0631	-62.0781

Man1	time	pos(x)	pos(y)	pos(z)	el	az	x1	y1	z1	x2	y2	z2
	0.816	5.0758	-0.4507	-59.5953	0.9272	2.9901	6.7766	-0.7104	-57.3016	3.3751	-0.191	-61.889
	0.832	4.4736	-0.7041	-60.6996	0.7658	3.1411	6.3448	-0.7051	-58.9004	2.6024	-0.7032	-62.4988
	0.848	4.1134	-1.2158	-61.8597	0.7151	-3.0034	6.3408	-0.9061	-59.9066	1.886	-1.5255	-63.8128
	0.864	3.8914	-0.419	-62.2959	0.8098	-2.9292	5.9167	0.0177	-60.1204	1.866	-0.8558	-64.4714
	0.88	3.9834	-0.4959	-62.7216	0.8663	-2.8269	5.5364	0.0096	-60.8001	2.4304	-1.0013	-64.6431
	0.896	3.3168	-0.5879	-63.9389	0.7057	-2.9124	5.2017	-0.1481	-62.2897	1.4318	-1.0277	-65.5881
	0.912	3.6871	0.2287	-63.8166	0.5788	-2.9934	6.0145	0.5763	-62.2787	1.3597	-0.1188	-65.3544
	0.928	3.1581	0.2221	-64.4974	0.6058	-2.8697	5.2983	0.8189	-62.9584	1.018	-0.3746	-66.0363
	0.944	3.5608	0.4163	-65.2681	0.5226	3.1321	6.288	0.3903	-63.6972	0.8337	0.4423	-66.839
	0.96	3.656	0.3213	-66.341	0.4882	3.0981	6.1178	0.2141	-65.0324	1.1942	0.4285	-67.6495
	0.976	3.3072	0.0419	-66.9959	0.418	3.076	6.048	-0.1382	-65.7757	0.5663	0.222	-68.216
	0.992	3.1693	0.0772	-68.0452	0.4133	3.1071	5.9831	-0.0199	-66.8104	0.3555	0.1743	-69.2799
	1.008	3.0003	-0.3127	-69.4229	0.6809	-3.0369	5.115	-0.0904	-67.7004	0.8856	-0.535	-71.1455
	1.024	3.2319	-0.1734	-70.5538	0.4118	-3.0664	6.3105	0.0586	-69.2053	0.1533	-0.4055	-71.9024
	1.04	2.7909	-0.1823	-71.3758	0.4656	-3.102	5.2574	-0.0847	-70.1356	0.3244	-0.2799	-72.6161
	1.056	2.9734	-0.218	-72.7188	0.4279	-3.1347	5.4109	-0.2011	-71.6072	0.5359	-0.2349	-73.8304
	1.072	2.7715	-0.4336	-74.0874	0.5505	3.135	4.976	-0.4482	-72.7341	0.567	-0.419	-75.4406
	1.088	2.9872	-0.3675	-75.3059	0.5414	-3.0789	5.3083	-0.2217	-73.9074	0.6661	-0.5133	-76.7043
	1.104	2.4527	-0.0285	-75.8503	0.3699	3.1218	4.9909	-0.0788	-74.8661	-0.0854	0.0218	-76.8346
	1.12	2.8363	-0.1452	-77.1957	0.3788	3.0146	5.258	-0.4543	-76.2241	0.4147	0.164	-78.1673
	1.136	2.6887	-0.3522	-78.2013	0.4998	2.952	4.6628	-0.7311	-77.1037	0.7146	0.0267	-79.2988
	1.152	2.5984	-0.2558	-79.4965	0.5074	3.093	4.9501	-0.3702	-78.1875	0.2467	-0.1414	-80.8054
	1.168	2.8025	-0.1637	-80.5788	0.5024	2.9776	4.915	-0.5134	-79.4024	0.69	0.186	-81.7553
	1.184	2.5588	-0.458	-81.7143	0.6382	2.9154	4.2182	-0.8399	-80.4513	0.8993	-0.0761	-82.9773
	1.2	2.5607	-0.0876	-83.0872	0.5343	2.8817	4.2652	-0.5409	-82.0436	0.8561	0.3657	-84.1308
	1.216	3.4814	-0.2536	-84.7445	0.774	2.6494	4.7543	-0.9361	-83.3329	2.2085	0.4289	-86.1562
	1.232	2.6281	-0.6702	-86.5159	1.2106	2.8751	3.2967	-0.8528	-84.676	1.9596	-0.4877	-88.3558
	1.248	2.9476	-0.5198	-87.538	1.004	2.8611	4.0626	-0.8411	-85.7149	1.8325	-0.1985	-89.3611
	1.264	3.1996	-0.6214	-89.3012	1.2466	2.861	3.9549	-0.8391	-86.9623	2.4442	-0.4037	-91.64
	1.28	3.4169	-1.1853	-91.3171	1.2839	2.8083	4.0583	-1.4073	-89.0168	2.7756	-0.9633	-93.6175
	1.296	3.632	-1.0282	-92.3515	1.5043	3.042	3.795	-1.0445	-89.8918	3.469	-1.0119	-94.8112
	1.312	3.3529	-0.6809	-92.993	1.529	2.0911	3.4028	-0.7679	-90.596	3.303	-0.5938	-95.39
	1.328	4.0131	-0.6643	-94.3466	1.4342	0.0905	3.6689	-0.6955	-91.8321	4.3573	-0.633	-96.8611
	1.344	4.5405	0.3075	-95.1525	1.4339	0.937	4.3471	0.0443	-92.7819	4.7339	0.5707	-97.5231
	1.36	4.651	0.0982	-96.0251	1.45	1.2415	4.5667	-0.1484	-93.8794	4.7352	0.3447	-98.1708
	1.376	4.823	0.1122	-96.9628	1.1612	0.8234	4.157	-0.6063	-94.7064	5.4889	0.8308	-99.2192
	1.392	4.9722	0.4758	-97.4861	1.2792	0.7645	4.4939	0.017	-95.2784	5.4505	0.9345	-99.6938
	1.408	4.9801	-0.2621	-98.5841	1.1201	1.2277	4.7088	-1.0214	-96.9179	5.2513	0.4972	-100.2503
	1.424	5.7778	0.1562	-100.2668	0.9342	0.8846	4.7715	-1.0724	-98.1187	6.784	1.3848	-102.4149
	1.44	5.6899	-0.0441	-100.9309	0.8471	0.4217	4.1531	-0.7336	-99.0245	7.2267	0.6454	-102.8373
	1.456	6.2181	0.1669	-101.9464	0.7101	0.661	4.6615	-1.0436	-100.251	7.7748	1.3775	-103.6418
	1.472	6.9041	-0.7373	-103.3359	0.71	0.4443	5.186	-1.5551	-101.7005	8.6221	0.0805	-104.9713
	1.488	7.2918	-0.0443	-104.1899	0.5218	0.4919	5.2505	-1.1382	-102.8585	9.333	1.0496	-105.5214
	1.504	7.4503	-0.4387	-104.8644	0.4251	0.5214	5.1064	-1.7852	-103.6406	9.7942	0.9078	-106.0882
	1.52	7.8478	-0.3527	-105.8042	0.5665	0.4182	5.8159	-1.2558	-104.3899	9.8798	0.5504	-107.2185
	1.536	7.7138	-0.782	-107.4095	0.67	0.1984	5.7554	-1.1757	-105.827	9.6722	-0.3884	-108.9921
	1.552	8.4468	-0.4393	-107.199	0.516	0.3562	6.1302	-1.3013	-105.797	10.7633	0.4228	-108.601
	1.568	8.6299	-0.5989	-108.304	0.4469	0.276	5.9473	-1.3587	-106.9678	11.3125	0.1608	-109.6403
	1.584	8.3845	-0.9581	-109.2422	0.6715	0.0994	6.0953	-1.1864	-107.4139	10.6737	-0.7298	-111.0705
	1.6	8.867	-0.4184	-110.1902	0.6993	-0.2628	6.9632	0.0938	-108.5319	10.7707	-0.9306	-111.8485
	1.616	9.0915	0.0115	-110.6915	0.5761	-0.0913	6.7844	0.2228	-109.1866	11.3986	-0.1997	-112.1963
	1.632	9.5968	-0.9505	-112.3073	0.7215	-0.4126	7.5991	-0.0761	-110.3891	11.5944	-1.8249	-114.2255
	1.648	10.292	-0.6757	-113.3074	0.4295	-0.2141	7.8873	-0.1527	-112.1802	12.6966	-1.1986	-114.4346
	1.664	11.1032	-0.7034	-113.9902	0.2873	-0.2863	8.3996	0.0926	-113.1574	13.8068	-1.4994	-114.8229
	1.68	11.525	0.0026	-114.9685	0.2075	-0.2122	8.9269	0.5623	-114.409	14.1231	-0.557	-115.5279
	1.696	12.3321	-0.4501	-115.7827	0.3723	-0.2348	10.1124	0.0809	-114.8913	14.5517	-0.9811	-116.674
	1.712	12.5766	-0.5364	-116.581	0.2731	-0.2639	10.6255	-0.0091	-116.0149	14.5278	-1.0637	-117.1471
	1.728	13.5895	-0.4701	-117.9835	0.0314	-0.039	11.0142	-0.3696	-117.9026	16.1648	-0.5706	-118.0644
	1.744	13.3415	-0.1929	-118.8131	0.0146	-0.3075	11.5678	0.3703	-118.7859	15.1151	-0.7561	-118.8403
	1.76	13.3729	0.0996	-120.4411	-0.2218	0.1666	11.216	-0.2632	-120.9343	15.5299	0.4623	-119.9478
	1.776	14.0261	-0.4021	-121.5971	-0.3497	0.0069	12.1213	-0.4152	-122.2917	15.9308	-0.389	-120.9026
	1.792	15.0314	-0.1724	-123.3363	-0.4526	0.177	12.8057	-0.5706	-124.4357	17.2571	0.2258	-122.2368
	1.808	15.1486	-0.2881	-124.6254	-0.4108	0.1231	13.1443	-0.536	-125.5049	17.1528	-0.0401	-123.7458
	1.824	15.3991	-0.421	-126.1991	-0.6244	0.3662	12.9609	-1.356	-128.0807	17.8372	0.5139	-124.3174
	1.84	16.7416	-0.2024	-127.4898	-0.5834	0.2509	14.2571	-0.8392	-129.1825	19.2261	0.4344	-125.7971
	1.856	17.3352	-0.3619	-128.8664	-0.7325	0.3989	15.4076	-1.1744	-130.7479	19.2628	0.4506	-126.9849

Man1	time	pos(x)	pos(y)	pos(z)	el	az	x1	y1	z1	x2	y2	z2
	1.872	17.9545	-0.4155	-130.5812	-0.7374	0.2827	16.1946	-0.9267	-132.2457	19.7144	0.0956	-128.9166
	1.888	18.4648	-0.5365	-131.8984	-0.6191	0.1996	16.2024	-0.9941	-133.543	20.7272	-0.0788	-130.2539
	1.904	19.6169	-0.2686	-133.4012	-0.6873	0.2035	17.3301	-0.7405	-135.3177	21.9038	0.2033	-131.4847
	1.92	20.0167	0.0888	-134.7881	-0.6367	0.152	17.707	-0.2652	-136.5158	22.3264	0.4427	-133.0605
	1.936	21.1962	0.1958	-136.4161	-0.6061	0.2852	18.9179	-0.4722	-138.0618	23.4746	0.8638	-134.7704
	1.952	21.7518	-0.2119	-138.0538	-0.5858	0.2421	19.0303	-0.8841	-139.9136	24.4733	0.4603	-136.194
	1.968	21.9934	0.4332	-139.9028	-0.1912	0.3077	19.5442	-0.3451	-140.4003	24.4425	1.2115	-139.4053
	1.984	22.7587	-0.2722	-142.3533	-0.1852	0.2712	19.9809	-1.0444	-142.8936	25.5365	0.5	-141.8131
	2	23.5229	-0.3472	-143.3405	0.0286	0.0833	20.0574	-0.6364	-143.2409	26.9884	-0.058	-143.4402
	2.016	23.5069	0.2576	-145.214	0.2579	0.0006	19.7341	0.2552	-144.2187	27.2798	0.2599	-146.2094
	2.032	23.3493	0.6623	-147.2754	0.3941	0.0659	20.2939	0.4608	-146.002	26.4047	0.8639	-148.5487
	2.048	23.4141	0.7342	-148.9891	0.4151	0.1137	20.5017	0.4017	-147.6972	26.3266	1.0667	-150.2811
	2.064	23.7108	1.744	-149.293	0.8487	0.2842	21.867	1.2054	-147.1122	25.5545	2.2826	-151.4737
	2.08	23.3646	1.27	-151.393	0.9461	0.2719	21.4251	0.7293	-148.6003	25.3042	1.8107	-154.1857
	2.096	23.0089	1.4486	-153.0116	1.2075	0.6876	22.1797	0.7675	-150.1893	23.8381	2.1296	-155.8339
	2.112	22.5143	0.5251	-154.6407	1.555	-1.0999	22.4945	0.5639	-151.8939	22.534	0.4863	-157.3875
	2.128	21.3853	0.9685	-156.2078	1.3837	2.4959	21.8316	0.6322	-153.2557	20.939	1.3047	-159.1599
	2.144	20.6914	1.0228	-157.17	1.2225	2.8486	21.6749	0.7261	-154.3411	19.7079	1.3196	-159.9988
	2.16	20.6316	0.6223	-158.1173	1.1224	-2.867	21.9253	0.9868	-155.3235	19.3378	0.2579	-160.9111
	2.176	20.6683	0.8086	-158.4595	0.9491	-3.0364	22.1044	0.9601	-156.444	19.2321	0.657	-160.475
	2.192	19.9328	0.7197	-159.0729	0.7574	3.0127	21.8259	0.4743	-157.268	18.0396	0.9651	-160.8778
	2.208	20.5197	-0.3049	-159.8208	0.539	-3.0235	22.7695	-0.038	-158.4658	18.2699	-0.5717	-161.1758
	2.224	20.1868	-0.2027	-160.6782	0.4611	-3.1141	22.5733	-0.1372	-159.4921	17.8003	-0.2683	-161.8643
	2.24	19.186	-0.0377	-160.9961	0.413	3.137	21.5615	-0.0486	-159.9552	16.8105	-0.0269	-162.0371
	2.256	19.2485	0	-161.2995	-0.1274	2.8722	21.7819	-0.6995	-161.6361	16.715	0.6995	-160.9629
	2.272	19.0302	0.1849	-162.1795	-0.053	2.6995	21.544	-1.0049	-162.3271	16.5164	1.3747	-162.0319
	2.288	19.1378	0.1969	-163.6772	-0.046	2.6988	21.7225	-1.0288	-163.8089	16.5531	1.4226	-163.5454
	2.304	19.0586	0.1628	-164.8096	-0.0075	2.7178	21.7297	-1.0422	-164.8317	16.3875	1.3677	-164.7874
	2.32	19.0765	-0.2684	-165.6511	-0.1232	2.8764	22.0742	-1.0824	-166.0357	16.0787	0.5456	-165.2664
	2.336	18.847	-0.1246	-166.6574	-0.0608	2.8971	21.9522	-0.8995	-166.8521	15.7419	0.6502	-166.4627
	2.352	18.2223	-0.1507	-168.3365	0.0724	2.8299	21.3827	-1.1691	-168.0958	15.062	0.8677	-168.5772
	2.368	18.6114	-0.0216	-169.7598	-0.0722	2.8522	21.6097	-0.9144	-169.9862	15.613	0.8712	-169.5333
	2.384	18.5064	-0.2105	-171.4247	-0.0641	2.7769	21.0437	-1.1792	-171.5989	15.969	0.7583	-171.2505
	2.4	17.9396	-0.4499	-172.3767	-0.135	2.7163	20.2776	-1.5087	-172.7254	15.6016	0.609	-172.0281
	2.416	17.5491	-0.1644	-174.3612	-0.0727	2.7341	20.326	-1.3632	-174.5814	14.7723	1.0344	-174.1411
	2.432	17.2858	-0.6768	-175.1652	-0.1004	2.8077	20.095	-1.6513	-175.4647	14.4765	0.2978	-174.8657
	2.448	16.6515	-0.7004	-176.508	-0.0996	2.7356	19.8348	-2.069	-176.8544	13.4682	0.6681	-176.1617
	2.464	16.623	-0.4814	-178.0205	-0.0894	2.8177	20.1159	-1.6541	-178.3508	13.1301	0.6912	-177.6902
	2.48	16.2821	-1.0037	-180.1029	-0.117	2.7818	19.4917	-2.2112	-180.5061	13.0726	0.2038	-179.6997
	2.496	15.8407	-0.5669	-181.7441	0.0058	2.692	18.5332	-1.8663	-181.7269	13.1481	0.7324	-181.7612
	2.512	15.0101	-0.8074	-183.1985	-0.0076	2.7325	17.9773	-2.0936	-183.2231	12.043	0.4789	-183.1739
	2.528	14.7109	-1.0691	-185.3022	-0.0112	2.8027	18.1268	-2.2733	-185.3427	11.2951	0.1351	-185.2618
	2.544	14.8715	-1.2562	-187.2212	0.0874	2.7819	17.9384	-2.4095	-186.9341	11.8047	-0.1029	-187.5084
	2.56	14.3662	-1.2335	-188.7614	0.2325	2.7067	16.7463	-2.3391	-188.14	11.986	-0.1278	-189.3828
	2.576	14.0181	-1.2414	-190.2494	0.2672	2.8264	16.9508	-2.1977	-189.405	11.0853	-0.285	-191.0938
	2.592	14.1623	-0.828	-192.4067	0.2234	2.7633	17.3304	-2.0873	-191.632	10.9942	0.4313	-193.1813
	2.608	13.3864	-1.7451	-194.2169	0.4088	3.0498	16.1343	-1.9979	-193.0217	10.6385	-1.4923	-195.4122
	2.624	14.3634	-2.2631	-195.7287	0.4925	3.0997	17.2864	-2.3855	-194.1587	11.4403	-2.1407	-197.2988
	2.64	15.029	-2.5208	-198.0028	0.684	-3.099	17.6326	-2.41	-195.8784	12.4254	-2.6317	-200.1272
	2.656	15.1227	-1.9618	-200.3076	1.1131	-2.9181	16.5549	-1.6363	-197.3259	13.6906	-2.2873	-203.2893
	2.672	15.184	-2.1784	-201.1169	1.2338	-2.8365	15.9983	-1.9219	-198.6802	14.3696	-2.4348	-203.5537
	2.688	16.3717	-2.4827	-202.8461	1.4068	-1.1822	16.1736	-1.9988	-199.6859	16.5698	-2.9666	-206.0062
	2.704	16.8772	-2.1593	-204.3395	1.3078	-0.0064	16.1563	-2.1546	-201.6615	17.5982	-2.1639	-207.0175
	2.72	18.6078	-2.2155	-204.6174	1.0989	-0.0781	17.2292	-2.1077	-201.9081	19.9863	-2.3234	-207.3267
	2.736	18.2279	-2.4982	-205.1198	0.9228	0.4092	16.3234	-3.324	-202.378	20.1324	-1.6723	-207.8617
	2.752	19.3256	-2.2745	-205.2355	0.6617	0.3318	16.6892	-3.1828	-203.064	21.9619	-1.3663	-207.407
	2.768	19.2937	-1.9403	-206.0425	0.7567	0.3545	17.1188	-2.7454	-203.8529	21.4686	-1.1352	-208.232
	2.784	20.3894	-2.5493	-205.9168	0.52	0.17	17.5913	-3.0296	-204.2913	23.1874	-2.0691	-207.5422
	2.8	21.9064	-1.9085	-206.9548	0.354	-0.0191	19.2037	-1.8568	-205.9558	24.6092	-1.9603	-207.9538
	2.816	20.9766	-1.6754	-207.7981	0.2872	-0.2053	18.2945	-1.1168	-206.9888	23.6588	-2.234	-208.6074
	2.832	21.574	-1.3802	-209.2219	0.2747	-0.1406	18.5066	-0.9461	-208.3488	24.6414	-1.8143	-210.095
	2.848	21.4352	-0.8992	-209.3505	0.2193	-0.132	18.777	-0.5462	-208.7529	24.0935	-1.2522	-209.9481
	2.864	22.3072	-1.0335	-210.4622	0.2298	-0.1653	19.8444	-0.6227	-209.8781	24.7699	-1.4442	-211.0464
	2.88	22.4177	-0.6899	-211.8434	0.1968	0.1368	19.9551	-1.0288	-211.3478	24.8803	-0.351	-212.3391
	2.896	22.7899	-0.5359	-213.0697	0.0959	-0.1664	20.3159	-0.1204	-212.8284	25.264	-0.9513	-213.311
	2.912	23.003	-0.3578	-214.1269	0.1725	-0.1734	21.2217	-0.0458	-213.8119	24.7843	-0.6697	-214.4419

Man1											
time	pos(x)	pos(y)	pos(z)	el	az	x1	y1	z1	x2	y2	z2
2.928	23.6349	-0.4378	-215.0912	0.1074	-0.1873	21.4337	-0.0207	-214.8497	25.836	-0.8549	-215.3326
2.944	24.0108	0.2616	-216.9194	0.2108	-0.1423	21.94	0.5584	-216.4717	26.0815	-0.0352	-217.3671
2.96	23.8866	-0.1042	-217.5111	0.1243	-0.2113	21.5086	0.4058	-217.2073	26.2647	-0.6142	-217.815
2.976	24.324	-0.2167	-219.8108	0.1369	-0.0913	21.7964	0.0148	-219.4611	26.8517	-0.4483	-220.1606
2.992	24.9045	0.2384	-221.0351	0.1493	-0.129	22.1277	0.5988	-220.6139	27.6813	-0.1219	-221.4563
3.008	25.1966	-0.1055	-222.6578	0.1429	-0.1058	22.582	0.1721	-222.2793	27.8112	-0.383	-223.0362
3.024	25.0643	0.2932	-223.5347	-0.0238	-0.1379	22.5639	0.64	-223.5949	27.5647	-0.0537	-223.4745
3.04	25.8771	0.3087	-225.7832	0.2219	-0.0477	23.0294	0.4447	-225.14	28.7248	0.1728	-226.4264
3.056	26.0228	0.1243	-227.4295	0.2586	-0.2171	23.4679	0.6877	-226.7374	28.5778	-0.4391	-228.1217
3.072	24.8747	1.2551	-229.69	0.1771	-0.143	22.2203	1.6373	-229.21	27.5292	0.8728	-230.17
3.088	25.1636	0.6277	-231.5971	0.2728	-0.247	22.1604	1.385	-230.7304	28.1668	-0.1295	-232.4637
3.104	25.2105	0.5891	-233.1327	0.6334	0.0438	22.8871	0.4872	-231.4248	27.5338	0.691	-234.8406
3.12	25.5992	0.2259	-234.7997	0.6211	0.1747	22.8796	-0.2542	-232.8235	28.3187	0.706	-236.7759
3.136	24.3358	-0.1522	-236.1067	0.8273	-0.2208	22.8047	0.1915	-234.4003	25.8669	-0.4959	-237.8132
3.152	24.4816	0.7568	-238.1329	0.9923	0.3988	22.9855	0.1263	-235.6469	25.9778	1.3873	-240.6188
3.168	23.8355	0.3426	-239.7524	1.0813	0.5717	22.4883	-0.5242	-236.7453	25.1826	1.2093	-242.7595
3.184	23.3008	1.2118	-242.1176	1.3746	0.6679	22.8233	0.8352	-239.0579	23.7782	1.5885	-245.1774
3.2	22.9022	0.8756	-242.8034	1.3314	1.0745	22.4891	0.1128	-239.2492	23.3152	1.6383	-246.3576
3.216	21.9568	-0.0722	-243.404	1.559	0.8052	21.9318	-0.0982	-240.3552	21.9817	-0.0463	-246.5428
3.232	20.8376	-0.1643	-244.1388	1.173	2.1427	21.5016	-1.196	-241.2195	20.1737	0.8674	-247.0581
3.248	20.8946	-0.6051	-244.7486	0.9559	-2.9744	22.5451	-0.3266	-242.3786	19.2441	-0.8837	-247.1187
3.264	20.5773	-0.919	-245.183	0.8576	-3.0619	22.1184	-0.7959	-243.3961	19.0362	-1.0421	-246.9699
3.28	20.0097	-0.2279	-246.3343	0.8665	2.6225	21.6968	-1.1918	-244.0474	18.3225	0.7361	-248.6212
3.296	19.3645	-1.1658	-246.6869	0.5361	-3.1063	22.2013	-1.0657	-245.0005	16.5277	-1.2659	-248.3732
3.312	19.2482	-1.0968	-247.0724	0.4836	3.0757	21.6773	-1.2571	-245.7939	16.8191	-0.9365	-248.3508
3.328	19.2923	-0.9238	-247.8069	0.3853	3.0149	22.4007	-1.3196	-246.5359	16.1839	-0.528	-249.0778
3.344	18.3842	-1.0108	-249.0119	0.4224	2.9394	20.9583	-1.5384	-247.831	15.8101	-0.4832	-250.1928
3.36	18.6383	-1.1351	-249.7504	0.2282	3.0444	21.6932	-1.433	-249.0375	15.5833	-0.8372	-250.4634
3.376	17.43	-1.003	-250.1855	0.2773	2.9813	20.7369	-1.5378	-249.2322	14.1232	-0.4683	-251.1388
3.392	17.0782	-0.6774	-251.5586	0.2352	2.9505	20.0385	-1.2502	-250.8361	14.1178	-0.1046	-252.2811
3.408	17.0844	-0.5063	-252.1053	0.173	2.8263	19.6578	-1.3457	-251.6324	14.511	0.333	-252.5782
3.424	17.1193	-0.9176	-253.2865	0.1878	2.9616	20.5234	-1.537	-252.6289	13.7151	-0.2981	-253.9441
3.44	17.4209	-1.4854	-254.0867	0.1299	2.9354	20.7878	-2.1898	-253.6374	14.054	-0.781	-254.5359
3.456	16.8256	-1.5591	-255.071	0.1413	2.9602	20.9309	-2.312	-254.4774	12.7203	-0.8061	-255.6646
3.472	16.5701	-1.0486	-256.6392	0.1115	2.9203	19.79	-1.7731	-256.2695	13.3501	-0.324	-257.0089
3.488	16.7997	-1.6355	-258.1505	0.1711	2.8749	20.1392	-2.5478	-257.5524	13.4602	-0.7232	-258.7486
3.504	16.6794	-1.2222	-259.5475	0.0891	2.8442	19.8803	-2.2031	-259.2486	13.4785	-0.2413	-259.8465
3.52	16.823	-1.6917	-261.0215	0.1718	2.8729	19.8479	-2.5247	-260.4771	13.7981	-0.8588	-261.5659
3.536	15.6271	-1.6072	-262.4915	0.2906	2.9403	18.4899	-2.1914	-261.6176	12.7643	-1.023	-263.3655
3.552	16.1088	-1.8926	-263.5517	0.0797	2.9151	18.9789	-2.5539	-263.3164	13.2387	-1.2313	-263.7871
3.568	15.2853	-1.4116	-265.3998	0.2311	2.8884	18.3374	-2.2012	-264.658	12.2331	-0.622	-266.1416
3.584	14.1104	-1.1218	-266.6283	0.2566	2.9546	16.7545	-1.6221	-265.9222	11.4663	-0.6215	-267.3345
3.6	13.9047	-1.4403	-268.567	0.1596	2.9804	17.2559	-1.9853	-268.0206	10.5536	-0.8953	-269.1134
3.616	13.7605	-1.4896	-270.3051	0.2615	2.946	16.735	-2.079	-269.4937	10.786	-0.9002	-271.1165
3.632	13.6009	-1.8269	-272.1649	0.254	3.0462	16.7459	-2.1279	-271.3446	10.4559	-1.5259	-272.9852
3.648	12.899	-1.7011	-273.5813	0.3176	3.0997	15.8852	-1.8263	-272.5987	9.9128	-1.576	-274.564
3.664	12.2678	-1.6966	-275.5721	0.5251	2.9475	15.1161	-2.2565	-273.8902	9.4195	-1.1367	-277.254
3.68	13.526	-2.0741	-277.3896	0.6619	2.9641	16.1332	-2.5417	-275.3256	10.9187	-1.6065	-279.4535
3.696	14.0657	-2.4369	-279.166	0.7346	-3.112	16.3743	-2.3685	-277.0798	11.7572	-2.5054	-281.2523
3.712	14.3883	-2.5515	-280.4213	0.8789	-3.0698	16.2199	-2.4198	-278.2049	12.5567	-2.6832	-282.6376
3.728	13.657	-2.7373	-282.3157	0.9091	-2.9505	15.4776	-2.3851	-279.9349	11.8365	-3.0896	-284.6965
3.744	15.2068	-2.8532	-284.2354	1.2828	-2.2513	15.7175	-2.2222	-281.4955	14.6961	-3.4842	-286.9753
3.76	15.7695	-3.1142	-285.0855	1.3386	-1.7432	15.8698	-2.538	-282.6118	15.6691	-3.6904	-287.5592
3.776	15.6183	-2.7478	-286.7116	1.3937	-0.0161	15.0684	-2.739	-283.6393	16.1681	-2.7567	-289.7839

Manta 2											
time	pos(x)	pos(y)	pos(z)	el	az	x1	y1	z1	x2	y2	z2
0	0	0	0	0.2489	-0.089	-2.65	0.2366	0.6763	2.65	-0.2366	-0.6763
0.016	1.0266	0.877	-1.9272	0.2283	-0.075	-2.4763	1.14	-1.111	4.5296	0.6139	-2.7435
0.032	-0.0059	1.6109	-5.034	0.5663	0.2217	-1.8329	1.1991	-3.8433	1.8211	2.0226	-6.2248
0.048	1.0642	1.812	-8.8975	0.6146	0.3052	-0.5879	1.2914	-7.6748	2.7164	2.3326	-10.1202
0.064	1.8726	1.7505	-13.0559	0.5801	1.3737	1.6398	0.5842	-12.2765	2.1055	2.9168	-13.8353
0.08	0.4249	1.1682	-17.104	1.1751	2.4841	1.0762	0.6653	-15.1342	-0.2264	1.671	-19.0738
0.096	1.0287	0.4673	-21.2231	1.098	2.9935	2.1314	0.3028	-19.0434	-0.0739	0.6319	-23.4027
0.112	0.4743	0.5906	-22.8637	0.5987	2.7264	1.9202	-0.0467	-21.7856	-0.9717	1.228	-23.9418

Man2	time	pos(x)	pos(y)	pos(z)	el	az	x1	y1	z1	x2	y2	z2
	0.128	-0.1544	0.9472	-24.8757	0.6953	2.7755	1.7058	0.2341	-23.2136	-20.146	1.6603	-26.5378
	0.144	0.2888	0.695	-26.5979	0.6755	2.73	1.6792	0.0881	-25.3823	-1.1016	1.302	-27.8134
	0.16	0.1526	0.8093	-27.673	0.4183	2.8227	1.9877	0.2034	-26.814	-1.6825	1.4152	-28.5321
	0.176	1.0865	1.1172	-28.4406	0.5096	2.7333	2.9009	0.3324	-27.336	-0.7278	1.9021	-29.5453
	0.192	0.7704	1.3447	-29.3054	0.6743	2.7226	2.1716	0.7207	-28.0793	-0.6309	1.9688	-30.5315
	0.208	1.9471	1.0416	-31.5114	1.1301	2.5677	2.5121	0.6763	-30.0848	1.382	1.4069	-32.938
	0.224	3.6751	0.8476	-32.5761	1.494	1.5585	3.6729	0.6721	-30.2962	3.6773	1.0231	-34.856
	0.24	4.2997	0.7749	-33.505	1.1989	0.5959	3.7704	0.416	-31.8656	4.8289	1.1339	-35.1444
	0.256	5.966	1.1659	-33.198	1.03	0.1767	4.6853	0.9372	-31.0315	7.2467	1.3946	-35.3644
	0.272	6.4472	1.1568	-33.7435	0.7596	0.352	4.9032	0.5897	-32.1815	7.9912	1.724	-35.3056
	0.288	7.509	1.2762	-34.0726	0.8668	0.0167	5.6969	1.2458	-31.9383	9.3212	1.3065	-36.207
	0.304	7.1236	1.2602	-34.1381	0.7368	0.0509	5.4868	1.1769	-32.6511	8.7604	1.3436	-35.6251
	0.32	7.3128	1.1139	-35.076	0.5785	0.096	5.3566	0.9256	-33.7927	9.2689	1.3022	-36.3593
	0.336	7.9869	0.8425	-35.7766	0.4864	0.1469	6.1268	0.5673	-34.7822	9.8471	1.1177	-36.771
	0.352	8.6044	0.4401	-36.6309	0.4565	-0.0327	6.1339	0.521	-35.4171	11.0748	0.3592	-37.8447
	0.368	9.0886	-0.0097	-37.3031	0.566	-0.0762	6.5638	0.1831	-35.6945	11.6133	-0.2024	-38.9118
	0.384	9.2923	0.2361	-37.6281	0.3975	0.0185	7.1699	0.1967	-36.7367	11.4148	0.2754	-38.5194
	0.4	9.51	-0.3088	-38.6094	0.2082	0.0255	7.6209	-0.3569	-38.2102	11.399	-0.2607	-39.0086
	0.416	10.4516	0.0646	-38.7365	0.4852	-0.2362	8.061	0.64	-37.4403	12.8421	-0.5108	-40.0328
	0.432	10.8866	-0.7664	-40.1167	0.3348	-0.0807	8.6884	-0.5888	-39.3494	13.0847	-0.9441	-40.8841
	0.448	10.8069	-0.4295	-39.8993	0.3414	-0.0916	8.7637	-0.2417	-39.1702	12.8501	-0.6173	-40.6284
	0.464	10.9222	-0.1303	-40.9026	0.57	-0.3146	9.4823	0.3382	-39.9321	12.3621	-0.5989	-41.8731
	0.48	10.5071	0.225	-40.9606	0.6125	-0.2324	8.5609	0.6856	-39.5552	12.4533	-0.2356	-42.366
	0.496	10.4587	-0.1301	-41.6896	0.7157	-0.21	8.7201	0.2404	-40.1439	12.1973	-0.5007	-43.2353
	0.512	11.0574	0.0065	-42.4661	0.597	-0.1442	9.1593	0.2821	-41.1622	12.9556	-0.2691	-43.77
	0.528	10.3407	-0.5544	-45.386	0.8423	-0.1708	8.5557	-0.2465	-43.3558	12.1258	-0.8622	-47.4162
	0.544	9.7441	-0.2108	-45.8302	0.782	0.046	8.2871	-0.2779	-44.3815	11.2011	-0.1437	-47.279
	0.56	9.1651	-0.2102	-47.3918	0.7904	-0.11	7.0438	0.0241	-45.2364	11.2864	-0.4445	-49.5473
	0.576	8.6847	-0.6017	-48.4762	0.8406	-0.1332	7.1512	-0.3963	-46.7481	10.2182	-0.8072	-50.2044
	0.592	8.5251	-0.5695	-49.476	0.864	0.0771	7.186	-0.673	-47.9033	9.8642	-0.4661	-51.0486
	0.608	8.1405	-0.2897	-50.0327	1.0452	0.1084	6.9916	-0.4147	-48.0401	9.2895	-0.1647	-52.0254
	0.624	7.6176	-0.1069	-50.7312	1.042	-0.2582	6.0176	0.3157	-47.8989	9.2176	-0.5294	-53.5635
	0.64	7.5592	-0.5398	-51.8927	1.1548	-0.3923	6.4001	-0.0602	-49.0534	8.7184	-1.0194	-54.7319
	0.656	6.8028	-1.0617	-53.3976	1.2873	-0.321	6.0001	-0.7947	-50.4937	7.6056	-1.3286	-56.3014
	0.672	6.4634	-1.1514	-54.7112	1.469	0.2223	6.2196	-1.2065	-52.2651	6.7072	-1.0963	-57.1573
	0.688	5.8804	-0.645	-55.4012	1.4019	-0.1035	5.4299	-0.5982	-52.7459	6.3308	-0.6918	-58.0565
	0.704	5.8438	-0.982	-56.5024	1.4045	-2.481	6.2135	-0.6947	-53.7132	5.4741	-1.2693	-59.2916
	0.72	5.6285	-1.3709	-58.1911	1.3334	-2.4843	6.1941	-0.9344	-55.2379	5.0629	-1.8074	-61.1444
	0.736	5.0672	-1.5357	-59.1897	1.2785	-2.5363	5.7485	-1.0643	-56.4363	4.3859	-2.0071	-61.9431
	0.752	4.9254	-2.0602	-60.3911	1.2199	-2.6116	5.8889	-1.4957	-57.3411	3.962	-2.6247	-63.4411
	0.768	4.7343	-2.1535	-61.4713	1.2603	-2.768	5.6561	-1.7922	-58.3862	3.8125	-2.5148	-64.5564
	0.784	4.1255	-1.6898	-62.1555	1.1859	-2.8169	5.1094	-1.3585	-59.5929	3.1416	-2.021	-64.7181
	0.8	3.9614	-1.8107	-62.8264	1.0189	-2.728	5.5928	-1.0946	-59.9326	2.33	-2.5268	-65.7203
	0.816	3.0887	-1.5514	-63.7093	0.8616	-2.9431	5.1631	-1.1341	-61.2436	1.0143	-1.9688	-66.175
	0.832	3.1513	-1.6373	-64.3683	0.7076	-3.0841	5.2986	-1.5138	-62.5285	1.0039	-1.7609	-66.208
	0.848	3.1116	-1.9225	-65.9722	0.721	-2.9356	5.4798	-1.4275	-63.8458	0.7433	-2.4174	-68.0985
	0.864	2.3811	-2.0114	-67.0839	0.7485	-2.9294	4.8605	-1.4774	-64.7281	-0.0984	-2.5455	-69.4398
	0.88	2.2171	-1.4586	-67.1935	0.5846	-3.0048	5.0228	-1.0724	-65.3192	-0.5886	-1.8448	-69.0679
	0.896	2.1498	-1.9266	-68.6555	0.6434	-2.9661	4.8584	-1.4463	-66.5929	-0.5588	-2.4069	-70.7181
	0.912	1.7313	-1.6782	-69.4721	0.5389	-2.9287	4.6383	-1.0497	-67.6939	-1.1757	-2.3067	-71.2503
	0.928	1.1485	-0.8458	-69.0892	0.3714	-3.0248	4.116	-0.4976	-67.9255	-1.8189	-1.1941	-70.2529
	0.944	1.414	-0.872	-70.4106	0.3627	-3.0358	4.4294	-0.5518	-69.26	-1.6013	-1.1922	-71.5612
	0.96	0.2242	-0.2201	-70.9742	0.3022	-3.0758	3.5696	0.0004	-69.9291	-3.1213	-0.4407	-72.0193
	0.976	0.1732	-0.5255	-72.0322	0.2844	-3.0569	3.2512	-0.2643	-71.129	-2.9048	-0.7867	-72.9354
	0.992	-0.7042	-0.156	-72.8708	0.2202	3.1132	2.5554	-0.2486	-72.1408	-3.9639	-0.0634	-73.6008
	1.008	-1.4954	0.6319	-73.2518	0.1341	3.0436	2.0741	0.2812	-72.768	-5.065	0.9827	-73.7356
	1.024	-1.1148	0.3897	-74.8922	0.1514	3.0775	1.7241	0.2075	-74.4581	-3.9537	0.5718	-75.3263
	1.04	-1.3011	0.3699	-76.3421	0.1158	2.982	1.4395	-0.0713	-76.0192	-4.0418	0.811	-76.665
	1.056	-2.4457	0.5346	-77.5713	0.0136	2.9871	0.3187	0.1042	-77.5332	-5.21	0.965	-77.6095
	1.072	-1.7547	0.4691	-78.9393	0.0415	3.0375	1.0315	0.1779	-78.8231	-4.5409	0.7603	-79.0555
	1.088	-2.39	0.4708	-79.8526	0.0757	3.0442	0.7253	0.1665	-79.6154	-5.5052	0.775	-80.0899
	1.104	-2.8773	1.0112	-80.8522	0.0385	3.0633	0.015	0.7842	-80.7404	-5.7695	1.2381	-80.9641
	1.12	-3.2319	1.1918	-83.0368	0.1519	2.9562	-0.1045	0.6055	-82.5498	-6.3593	1.7782	-83.5238
	1.136	-4.0631	1.1219	-84.8237	0.0703	3.0277	-0.6379	0.7301	-84.5809	-7.4883	1.5137	-85.0665
	1.152	-3.7598	1.5696	-86.3633	0.0876	3.0278	-0.6542	1.2147	-86.0889	-6.8654	1.9246	-86.6377
	1.168	-3.5306	1.456	-87.3979	0.1731	3.0469	-0.6765	1.185	-86.8967	-6.3847	1.727	-87.8992

Man2	time	pos(x)	pos(y)	pos(z)	el	az	x1	y1	z1	x2	y2	z2
	1.184	-4.0254	1.5354	-88.9051	0.1475	3.0188	-1.1887	1.1853	-88.4803	-6.8621	1.8854	-89.3298
	1.2	-4.1122	1.7916	-90.4139	0.1068	2.9885	-0.6945	1.2644	-90.0431	-7.5299	2.3189	-90.7848
	1.216	-3.9552	1.7814	-92.0694	0.1254	2.9199	-1.0648	1.1299	-91.6958	-6.8456	2.4328	-92.4431
	1.232	-4.073	1.7543	-93.5571	0.1997	3.038	-0.8426	1.4183	-92.8998	-7.3034	2.0903	-94.2143
	1.248	-4.4782	1.8466	-95.3413	0.1095	2.9936	-1.1731	1.3537	-94.974	-7.7833	2.3395	-95.7086
	1.264	-4.2404	1.732	-96.8313	0.252	2.8898	-1.5027	1.0276	-96.1035	-6.9781	2.4364	-97.5592
	1.28	-4.0354	2.2283	-98.8473	0.3556	2.8329	-1.5345	1.4309	-97.8724	-6.5362	3.0257	-99.8223
	1.296	-4.1719	2.3318	-100.316	0.134	2.8809	-1.7633	1.6893	-99.9799	-6.5804	2.9744	-100.652
	1.312	-4.404	2.3677	-101.3877	0.3666	2.614	-2.5962	1.3142	-100.5843	-6.2118	3.4212	-102.1911
	1.328	-4.9254	2.4119	-103.4356	0.4779	2.5177	-3.2944	1.2379	-102.3947	-6.5565	3.5859	-104.4765
	1.344	-5.1291	3.0743	-104.9622	0.5044	2.6003	-3.2998	1.9747	-103.7839	-6.9584	4.174	-106.1405
	1.36	-4.4449	2.8501	-107.5216	0.8739	2.3633	-3.2995	1.7209	-105.5999	-5.5903	3.9794	-109.4432
	1.376	-4.7467	2.7186	-109.0646	0.9867	2.6367	-3.456	2.0053	-106.8338	-6.0375	3.432	-111.2954
	1.392	-3.457	2.3929	-110.7578	1.2488	2.1046	-3.0846	1.7629	-108.5643	-3.8293	3.023	-112.9512
	1.408	-3.1218	2.3956	-112.1654	1.3796	1.2957	-3.262	1.8989	-109.4999	-2.9817	2.8922	-114.8308
	1.424	-2.1167	1.9221	-113.5862	1.3496	1.143	-2.3281	1.4586	-111.3204	-1.9054	2.3856	-115.8519
	1.44	-2.346	2.1562	-114.8514	1.333	1.8439	-2.1829	1.5737	-112.3561	-2.5092	2.7387	-117.3467
	1.456	-1.7466	1.7394	-115.36	1.0851	-0.0938	-2.9666	1.8542	-113.0386	-0.5265	1.6246	-117.6813
	1.472	-1.7581	1.7594	-115.9822	0.8949	-0.2873	-3.3758	2.2374	-113.8787	-0.1405	1.2815	-118.0857
	1.488	-0.8488	1.4072	-116.5355	0.792	-0.2151	-2.8201	1.8378	-114.4909	1.1224	0.9765	-118.5801
	1.504	-0.9114	1.4592	-117.3197	0.7808	-0.1269	-2.6985	1.6872	-115.5345	0.8757	1.2311	-119.105
	1.52	-0.4175	1.0016	-118.478	0.7264	-0.4347	-3.0254	2.2125	-115.9232	2.1904	-0.2093	-121.0328
	1.536	-0.2933	0.6486	-119.1112	0.6683	-0.2006	-2.2414	1.0448	-117.5416	1.6548	0.2524	-120.6808
	1.552	0.2659	0.1226	-120.1252	0.5091	-0.3275	-2.2259	0.9691	-118.6564	2.7578	-0.7238	-121.594
	1.568	0.3745	-0.1936	-120.6515	0.4713	-0.4724	-2.0427	1.0415	-119.268	2.7918	-1.4287	-122.035
	1.584	0.6974	-0.3271	-121.1019	0.3221	-0.4144	-1.8759	0.805	-120.1636	3.2707	-1.4592	-122.0402
	1.6	0.3727	-0.6012	-122.3661	0.1858	-0.364	-2.1818	0.3721	-121.8523	2.9272	-1.5745	-122.8799
	1.616	0.9712	-1.1321	-123.3034	0.128	-0.6094	-1.892	0.8663	-122.8538	3.8344	-3.1305	-123.7529
	1.632	0.6755	-0.8431	-123.7868	0.1233	-0.504	-1.82	0.533	-123.4336	3.171	-2.2192	-124.1401
	1.648	1.6979	-0.7445	-125.1129	0.0618	-0.5954	-0.9283	1.0344	-124.9166	4.3241	-2.5235	-125.3092
	1.664	1.5947	-0.9527	-126.0288	-0.0063	-0.5938	-0.6582	0.5683	-126.046	3.8477	-2.4737	-126.0116
	1.68	1.6892	-0.8358	-126.8528	-0.2031	-0.584	-0.4957	0.6083	-127.3921	3.874	-2.2799	-126.3135
	1.696	2.4752	-0.6333	-128.4284	-0.3333	-0.5408	-0.1328	0.9329	-129.4817	5.0833	-2.1996	-127.375
	1.712	2.9352	-0.2782	-129.7241	-0.4158	-0.6853	0.9685	1.3297	-130.8457	4.902	-1.886	-128.6024
	1.728	2.8944	-0.6816	-130.8989	-0.4674	-0.7513	1.1913	0.9092	-132.0752	4.5974	-2.2724	-129.7227
	1.744	3.558	-1.1755	-132.1208	-0.5752	-0.6544	1.8817	0.1107	-133.4907	5.2344	-2.4616	-130.7508
	1.76	3.7656	-2.4856	-133.4618	-0.854	-0.2162	2.1057	-2.121	-135.412	5.4255	-2.8502	-131.5116
	1.776	4.6163	-2.9901	-134.9175	-0.9326	-0.2197	3.1105	-2.6538	-136.9976	6.1221	-3.3265	-132.8375
	1.792	4.8539	-2.9022	-135.7758	-1.0007	-0.1457	3.2799	-2.6712	-138.2571	6.4279	-3.1332	-133.2945
	1.808	5.2583	-3.5049	-136.4776	-1.1578	0.0316	4.1021	-3.5414	-139.1171	6.4144	-3.4683	-133.8381
	1.824	6.2258	-3.2094	-136.9938	-1.1413	0.1653	5.1521	-3.3886	-139.3708	7.2995	-3.0302	-134.6169
	1.84	6.2848	-3.5901	-138.1694	-1.3475	-0.5503	5.8306	-3.3114	-140.516	6.739	-3.8687	-135.8228
	1.856	7.2115	-3.5162	-139.1704	-1.3874	2.8504	7.6568	-3.6497	-141.6758	6.7663	-3.3828	-136.6651
	1.872	7.2201	-3.3287	-139.9237	-1.5263	-0.8078	7.1479	-3.2532	-142.2711	7.2923	-3.4041	-137.5763
	1.888	8.0505	-3.504	-140.5495	-1.5138	2.3826	8.1478	-3.5963	-142.9009	7.9532	-3.4117	-138.1981
	1.904	9.2988	-3.946	-141.1698	-1.4012	2.8034	9.6432	-4.0672	-143.3017	8.9544	-3.8249	-139.0379
	1.92	10.6216	-4.4325	-142.2493	-1.5	1.6897	10.6438	-4.6185	-144.8927	10.5993	-4.2465	-139.6059
	1.936	10.6976	-4.7306	-142.4724	-1.4479	2.6535	10.9593	-4.8696	-144.8704	10.4359	-4.5917	-140.0744
	1.952	11.2807	-4.6908	-143.3477	-1.4893	2.8898	11.4687	-4.7392	-145.7241	11.0926	-4.6424	-140.9713
	1.968	12.2652	-4.8298	-144.0456	-1.3908	2.2718	12.5788	-5.2013	-146.7168	11.9516	-4.4582	-141.3744
	1.984	13.2105	-4.7384	-144.1778	-1.3398	2.8314	13.8131	-4.9315	-146.8679	12.6079	-4.5452	-141.4876
	2	13.6726	-5.0988	-145.0674	-1.1967	2.8283	14.5846	-5.3942	-147.5095	12.7606	-4.8034	-142.6252
	2.016	13.99	-5.1916	-145.5742	-1.3024	2.9988	14.7477	-5.3006	-148.357	13.2324	-5.0827	-142.7914
	2.032	14.6258	-5.2839	-146.2451	-1.0558	2.9305	16.0192	-5.5825	-148.7633	13.2325	-4.9854	-143.727
	2.048	15.2321	-5.4559	-146.2152	-1.0627	2.7548	16.4482	-5.9513	-148.5733	14.016	-4.9605	-143.8572
	2.064	15.7673	-4.9939	-147.4847	-0.884	2.8085	17.558	-5.6134	-149.7956	13.9766	-4.3744	-145.1737
	2.08	15.9059	-4.7548	-148.3752	-0.8334	2.8556	17.7816	-5.3063	-150.5275	14.0302	-4.2034	-146.2228
	2.096	16.1018	-5.2155	-149.4621	-0.8559	2.7472	17.8328	-5.936	-151.6221	14.3709	-4.4951	-147.302
	2.112	16.6993	-5.2411	-149.8864	-0.847	2.7998	18.5339	-5.8938	-152.0895	14.8646	-4.5884	-147.6832
	2.128	16.9743	-5.1328	-150.7544	-0.8651	2.8062	18.8923	-5.8012	-153.1381	15.0563	-4.4643	-148.3708
	2.144	17.6578	-5.0282	-151.2187	-0.8536	2.8891	19.6024	-5.5299	-153.5216	15.7132	-4.5266	-148.9158
	2.16	17.9688	-5.1445	-151.9486	-0.8568	2.7689	19.7029	-5.8224	-154.0976	16.2346	-4.4666	-149.7996
	2.176	18.2969	-4.8735	-152.8492	-0.9051	2.9059	20.0002	-5.2825	-155.0799	16.5936	-4.4645	-150.6185
	2.192	18.2646	-4.5446	-153.623	-0.9597	2.8844	20.0727	-5.0202	-156.2918	16.4565	-4.0691	-150.9542
	2.208	19.0719	-4.7315	-154.3704	-0.9515	2.9392	20.7245	-5.0706	-156.737	17.4192	-4.3924	-152.0037
	2.224	18.9947	-4.6964	-155.428	-0.8947	2.863	20.6985	-5.1837	-157.637	17.2909	-4.2092	-153.219

Man2	time	pos(x)	pos(y)	pos(z)	el	az	x1	y1	z1	x2	y2	z2
	2.24	19.2436	-4.474	-156.2704	-0.9089	3.0103	20.6703	-4.6624	-158.1176	17.8169	-4.2856	-154.4232
	2.256	19.2602	-4.4331	-156.7612	-0.9727	2.9641	20.839	-4.7163	-159.1157	17.6813	-4.1498	-154.4068
	2.272	19.8281	-4.5062	-157.8312	-1.0231	3.0602	21.3429	-4.6297	-160.3231	18.3133	-4.3826	-155.3393
	2.288	19.8765	-3.9708	-158.3973	-1.0493	3.0734	21.1529	-4.058	-160.624	18.6002	-3.8836	-156.1705
	2.304	19.7774	-4.0198	-159.4678	-0.9132	-3.0463	21.5289	-3.8524	-161.7462	18.0258	-4.1872	-157.1893
	2.32	19.9779	-3.9119	-160.1776	-0.9943	-3.0292	21.5688	-3.7324	-162.6398	18.3871	-4.0914	-157.7153
	2.336	20.1603	-3.8716	-161.1595	-1.0957	3.0637	21.3436	-3.964	-163.467	18.9769	-3.7792	-158.852
	2.352	19.9792	-3.5856	-161.9898	-0.9942	-2.5828	21.2628	-2.783	-164.3174	18.6956	-4.3882	-159.6621
	2.368	19.0977	-3.2682	-162.6151	-1.0945	-2.9057	20.1986	-3.0036	-164.8098	17.9968	-3.5329	-160.4204
	2.384	19.3764	-3.7318	-163.4683	-0.9811	-2.5453	20.5691	-2.9224	-165.6225	18.1836	-4.5413	-161.314
	2.4	19.8258	-3.1758	-164.4342	-1.0307	-2.4078	20.8811	-2.2241	-166.8044	18.7705	-4.1274	-162.064
	2.416	18.8534	-3.3303	-164.9985	-1.0023	-2.1549	19.7085	-2.0368	-167.4255	17.9983	-4.6237	-162.5716
	2.432	19.2831	-2.8596	-165.6134	-1.1208	-2.3718	20.2539	-1.9186	-168.4123	18.3123	-3.8006	-162.8144
	2.448	19.1985	-2.3801	-166.417	-1.0688	-2.1981	20.0195	-1.2477	-168.9653	18.3775	-3.5125	-162.8688
	2.464	19.3318	-2.1505	-167.079	-1.0891	-2.1364	20.0871	-0.9609	-169.7748	18.5766	-3.3402	-164.3833
	2.48	18.6675	-2.458	-167.6588	-1.0382	-1.9359	19.1737	-1.1334	-170.0645	18.1612	-3.7826	-165.253
	2.496	19.2959	-1.8762	-168.7485	-0.919	-1.7067	19.5365	-0.1172	-171.0752	19.0554	-3.6351	-166.4217
	2.512	19.3552	-2.5737	-169.5686	-0.8951	-1.6202	19.4469	-0.72	-171.8842	19.2635	-4.4274	-167.253
	2.528	19.4059	-2.0889	-171.2621	-0.9623	-1.621	19.4978	-0.259	-173.8922	19.3141	-3.9188	-168.632
	2.544	19.4532	-1.8871	-171.5725	-0.9	-1.6123	19.5265	-0.1229	-173.7976	19.3798	-3.6512	-169.3474
	2.56	19.5143	-1.0785	-172.5551	-0.9575	-1.5528	19.484	0.6078	-174.9517	19.5447	-2.7649	-170.1586
	2.576	19.3494	-1.0867	-173.2151	-0.8963	-1.6708	19.5471	0.8849	-175.6934	19.1517	-3.0582	-170.7368
	2.592	19.0524	-1.2728	-174.0482	-0.9498	-1.6064	19.1139	0.4534	-176.4623	18.9909	-2.9989	-171.6341
	2.608	19.2547	-1.1738	-174.5647	-0.8901	-1.632	19.3804	0.878	-177.1034	19.129	-3.2257	-172.0261
	2.624	19.2639	-1.1803	-175.4411	-0.867	-1.7159	19.5598	0.8452	-177.8529	18.968	-3.2057	-173.0293
	2.64	19.4727	-0.9704	-176.1209	-0.9676	-1.2792	18.9826	0.6622	-178.5954	19.9628	-2.603	-173.6465
	2.656	19.5309	-1.6904	-177.3279	-0.8868	-1.5469	19.482	0.3519	-179.8338	19.5798	-3.7328	-174.822
	2.672	19.7515	-0.5676	-178.5976	-1.0216	-1.7138	19.9957	1.1281	-181.397	19.5073	-2.2632	-175.7983
	2.688	19.3164	-1.0547	-179.107	-0.8356	-1.7171	19.6442	1.1697	-181.5931	18.9886	-3.2791	-176.6208
	2.704	19.7584	-0.6026	-179.9664	-0.8868	-1.7223	20.096	1.6079	-182.709	19.4209	-2.813	-177.2238
	2.72	19.8725	-0.9749	-180.8144	-0.8568	-1.7245	20.2132	1.2239	-183.3824	19.5318	-3.1737	-178.2463
	2.736	19.9349	-1.1557	-181.7434	-0.8209	-1.7639	20.3625	1.0307	-184.1352	19.5073	-3.3421	-179.3517
	2.752	20.0171	-1.2714	-182.8634	-0.8771	-1.8959	20.6559	0.624	-185.2687	19.3783	-3.1668	-180.4581
	2.768	20.1237	-1.6325	-183.986	-0.8394	-1.7295	20.4912	0.664	-186.5775	19.7562	-3.929	-181.3946
	2.784	19.7396	-1.2876	-184.9918	-0.9528	-1.3806	19.3876	0.541	-187.6113	20.0916	-3.1161	-182.3723
	2.8	19.5236	-1.5149	-186.072	-0.9385	-1.3167	19.0157	0.4403	-188.8294	20.0315	-3.4701	-183.3147
	2.816	19.7769	-1.7376	-187.2131	-1.1073	-1.8293	20.1498	-0.3276	-190.131	19.4041	-3.1476	-184.2952
	2.832	19.6317	-2.0588	-188.2809	-1.1728	-1.6174	19.6844	-0.9289	-190.9712	19.579	-3.1887	-185.5905
	2.848	19.9443	-2.3086	-189.2613	-1.13	-1.6561	20.0691	-0.8491	-192.3662	19.8195	-3.7681	-186.1564
	2.864	19.8346	-2.4431	-190.0484	-1.1711	-1.7057	20.0096	-1.154	-193.1285	19.6596	-3.7322	-186.9684
	2.88	19.1975	-2.5692	-190.7555	-1.2592	-1.3955	19.0328	-1.639	-193.6881	19.3623	-3.4993	-187.823
	2.896	19.3392	-2.7751	-191.8047	-1.2338	-0.9982	18.8079	-1.9509	-194.6035	19.8706	-3.5993	-189.0059
	2.912	19.3007	-2.9951	-193.2853	-1.2299	-0.6264	18.39	-2.3362	-196.4537	20.2114	-3.654	-190.1168
	2.928	19.1263	-3.0399	-194.1088	-1.3152	-0.7112	18.5341	-2.5296	-197.1003	19.7186	-3.5502	-191.1174
	2.944	19.5687	-3.0393	-194.8461	-1.3104	-0.3568	18.847	-2.7703	-197.7365	20.2904	-3.3083	-191.9556
	2.96	19.1439	-3.4582	-196.0907	-1.2731	-0.7616	18.4867	-2.8316	-199.0501	19.8011	-4.0848	-193.1313
	2.976	19.243	-3.9158	-196.9898	-1.2881	-0.0581	18.3157	-3.8619	-200.1877	20.1704	-3.9697	-193.792
	2.992	19.6474	-4.5388	-197.5906	-1.2997	-0.2676	18.7602	-4.2956	-200.8997	20.5345	-4.7821	-194.2815
	3.008	19.1723	-4.7269	-198.4576	-1.0817	-0.2356	17.7047	-4.3746	-201.2937	20.6399	-5.0793	-195.6215
	3.024	18.9519	-5.0557	-198.6885	-1.1364	-0.0057	17.5918	-5.048	-201.6202	20.3121	-5.0635	-195.7569
	3.04	19.5032	-5.3166	-199.6919	-1.3153	0.1268	18.7217	-5.4162	-202.7073	20.2847	-5.217	-196.6765
	3.056	18.7723	-5.142	-200.6784	-1.1225	0.1627	17.5438	-5.3436	-203.2668	20.0008	-4.9404	-198.0901
	3.072	19.4571	-5.6284	-201.4162	-1.1234	0.6248	18.3823	-6.4036	-204.1779	20.5319	-4.8533	-198.6544
	3.088	19.6269	-6.0981	-202.2014	-1.0332	0.7829	18.585	-7.1347	-204.6668	20.6688	-5.0614	-199.7361
	3.104	19.8443	-6.3422	-202.9865	-0.9678	0.8077	18.6861	-7.5532	-205.4201	21.0025	-5.1312	-200.5529
	3.12	20.0094	-6.3656	-203.9948	-1.0693	0.6732	18.9173	-7.2365	-206.5426	21.1015	-5.4947	-201.447
	3.136	20.4218	-6.4473	-204.7599	-0.9842	0.7033	19.2099	-7.475	-207.1506	21.6337	-5.4196	-202.3692
	3.152	20.2205	-6.6583	-205.4204	-0.8409	0.8908	18.8917	-8.3016	-207.7825	21.5493	-5.015	-203.0584
	3.168	20.4904	-6.9079	-206.3394	-1.0091	0.9408	19.5684	-8.1724	-208.826	21.4124	-5.6434	-203.8527
	3.184	21.0177	-7.2083	-207.3867	-1.0519	1.2093	20.4887	-8.6073	-210.0058	21.5466	-5.8092	-204.7676
	3.2	21.1502	-7.4044	-207.9597	-1.0101	0.9968	20.2999	-8.7193	-210.4535	22.0005	-6.0895	-205.4659
	3.216	21.2033	-7.5697	-208.7164	-0.8573	1.0207	20.1978	-9.2093	-210.9385	22.2089	-5.9301	-206.4942
	3.232	21.6613	-7.7739	-209.3657	-0.964	1.049	20.8653	-9.1584	-211.6665	22.4573	-6.3894	-207.0648
	3.248	22.0843	-7.779	-210.448	-0.9103	1.114	21.3393	-9.2947	-212.6218	22.8293	-6.2633	-208.2742
	3.264	22.4088	-7.6741	-210.8937	-0.9338	1.7981	22.7907	-9.3244	-213.183	22.027	-6.0237	-208.6043
	3.28	22.7803	-8.3029	-211.4868	-0.9941	1.4095	22.5545	-9.6903	-213.6479	23.0061	-6.9155	-209.3258

Man2	time	pos(x)	pos(y)	pos(z)	el	az	x1	y1	z1	x2	y2	z2
	3.296	22.5839	-8.444	-211.9628	-0.9967	1.5241	22.5156	-9.9074	-214.2278	22.6523	-6.9806	-209.6979
	3.312	23.2906	-8.5974	-213.3275	-1.1013	1.358	23.0358	-9.7768	-215.706	23.5455	-7.4179	-210.949
	3.328	23.5866	-8.009	-214.7589	-1.0303	1.5843	23.6054	-9.3976	-217.073	23.5679	-6.6205	-212.4447
	3.344	23.8077	-8.2147	-214.6627	0.6935	0.165	22.9282	-8.3611	-213.9216	24.6872	-8.0683	-215.4038
	3.36	23.8813	-8.2386	-215.9471	0.536	0.1353	23.2645	-8.3225	-215.5774	24.4981	-8.1546	-216.3169
	3.376	24.7831	-7.3962	-217.0337	0.0394	0.6505	23.7997	-8.1446	-216.985	25.7666	-6.6477	-217.0825
	3.392	25.1902	-7.4014	-217.7771	0.0823	0.8541	24.4349	-8.2683	-217.6822	25.9456	-6.5344	-217.8719
	3.408	25.0588	-8.0078	-218.9196	-0.7882	1.6994	25.3368	-10.1576	-221.0995	24.7809	-5.8581	-216.7397
	3.424	24.9363	-7.5799	-219.7193	-0.9269	1.8264	25.41	-9.3932	-222.2162	24.4625	-5.7665	-217.2224
	3.44	25.8206	-8.226	-220.5576	-0.9837	2.1811	26.9009	-9.7707	-223.3906	24.7403	-6.6813	-217.7247
	3.456	24.8158	-8.0454	-220.7729	-1.2649	2.2289	25.3831	-8.7791	-223.7097	24.2485	-7.3116	-217.836
	3.472	25.3297	-7.9559	-221.8214	-1.1332	2.7143	26.4671	-8.4738	-224.4925	24.1923	-7.4381	-219.1503
	3.488	25.9804	-7.6877	-222.7368	-1.1103	2.3227	26.9043	-8.6756	-225.4638	25.0564	-6.6998	-220.0097
	3.504	26.0717	-8.6354	-223.0118	-1.1147	2.9846	27.3656	-8.8402	-225.6823	24.7777	-6.4306	-220.3412
	3.52	26.8777	-7.7672	-224.572	-1.0384	2.6679	28.2829	-8.4875	-227.2523	25.4725	-7.0469	-221.8916
	3.536	26.1449	-8.0683	-224.7234	-1.0452	2.6358	27.3898	-8.7578	-227.1772	24.9	-7.3788	-222.2696
	3.552	26.8683	-7.9507	-225.5012	-1.1224	2.6205	27.9587	-8.5766	-228.1147	25.7779	-7.3248	-222.8877
	3.568	26.3549	-8.2966	-226.641	-1.0402	2.9216	27.9331	-8.6495	-229.3975	24.7767	-7.9438	-223.8846
	3.584	26.7005	-8.0947	-227.5199	-1.1132	2.9547	28.0663	-8.3529	-230.3426	25.3347	-7.8365	-224.6971
	3.6	26.8966	-7.5797	-228.7989	-1.0626	3.0844	28.7413	-7.6853	-232.116	25.0519	-7.474	-225.4818
	3.616	27.5811	-7.865	-229.7662	-1.0786	2.8543	28.9034	-8.2557	-232.3373	26.2588	-7.4743	-227.195
	3.632	27.7027	-7.7774	-230.8544	-1.0695	3.099	29.221	-7.842	-233.6278	26.1845	-7.7127	-228.081
	3.648	28.0501	-8.6642	-231.2109	-1.0274	2.8067	29.5797	-9.1964	-233.8922	26.5206	-8.1319	-228.5297
	3.664	27.7114	-8.2804	-232.0195	-1.0367	3.0529	29.3583	-8.4268	-234.8149	26.0645	-8.134	-229.2242
	3.68	28.5461	-7.4201	-233.0432	-1.0969	-2.8149	30.0031	-6.9265	-236.0425	27.0891	-7.9138	-230.0438
	3.696	28.3779	-7.3789	-234.0253	-1.0688	-3.0987	29.9801	-7.3102	-236.9466	26.7758	-7.4476	-231.104
	3.712	28.8359	-7.9585	-235.5003	-0.9287	-3.1323	30.9188	-7.9392	-238.2857	26.753	-7.9777	-232.7148
	3.728	29.1252	-8.1425	-236.5692	-0.9174	-2.8981	30.9667	-7.685	-239.0477	27.2838	-8.6001	-234.0907
	3.744	28.8981	-7.6434	-236.8494	-1.019	-2.8433	30.4535	-7.1652	-239.4927	27.3428	-8.1215	-234.2062
	3.76	29.3141	-7.4946	-238.0255	-0.8688	-2.9448	31.1538	-7.1279	-240.2436	27.4744	-7.8614	-235.8073
	3.776	29.23	-7.7799	-239.0688	-0.7531	-3.0108	31.7428	-7.4494	-241.4447	26.7171	-8.1104	-236.6929
	3.792	29.7226	-7.2718	-240.1524	-0.7584	-2.9228	32.7046	-6.6087	-243.0468	26.7405	-7.9349	-237.2579
	3.808	30.2815	-6.603	-241.0566	-0.8224	-2.7767	33.0466	-5.5467	-244.244	27.5163	-7.6593	-237.8692
	3.824	29.2906	-6.4995	-241.7939	-0.7784	-2.718	31.6981	-5.4139	-244.398	26.8831	-7.5851	-239.1898
	3.84	29.9823	-6.5697	-242.977	-0.8639	-2.7574	32.3861	-5.5979	-246.0124	27.5785	-7.5415	-239.9415
	3.856	30.3154	-6.5443	-244.133	-0.8705	-2.6416	32.4639	-5.3706	-247.038	28.167	-7.7179	-241.228
	3.872	30.1809	-5.9264	-245.1666	-0.8349	-2.7889	32.5868	-5.0408	-247.9977	27.7749	-6.8119	-242.3354
	3.888	29.1103	-6.0261	-246.4849	-0.7688	-2.8305	31.8811	-5.1351	-249.3002	26.3395	-6.9172	-243.6695
	3.904	29.2681	-5.5541	-246.7302	-0.8055	-2.7593	32.1181	-4.4082	-249.928	26.4181	-6.6999	-243.5325
	3.92	29.949	-5.5809	-247.8469	-0.8546	-2.7026	32.0678	-4.586	-250.5362	27.8303	-6.5758	-245.1576
	3.936	28.6681	-5.302	-248.9962	-0.9397	-2.6534	30.8151	-4.1619	-252.3227	26.521	-6.4422	-245.6698
	3.952	28.9439	-5.4357	-249.6198	-0.8401	-2.6134	30.6874	-4.4185	-251.8721	27.2004	-6.4529	-247.3675
	3.968	28.2325	-5.6891	-251.088	-1.0228	-2.3465	29.355	-4.5447	-253.7143	27.1099	-6.8335	-248.4616
	3.984	27.9295	-5.5269	-251.5763	-1.0636	-2.1108	28.7185	-4.2105	-254.3382	27.1405	-6.8433	-248.8143
	4	27.4748	-4.9266	-252.4349	-1.053	-2.0947	28.3352	-3.4374	-255.4539	26.6144	-6.4157	-249.4159
	4.016	28.2628	-4.5272	-253.1093	-1.055	-2.0964	29.1398	-3.0153	-256.1921	27.3858	-6.0392	-250.0265
	4.032	28.4652	-5.0763	-253.7129	-1.0451	-1.9052	28.9904	-3.565	-256.4705	27.9401	-6.5877	-250.9554
	4.048	27.339	-4.0681	-254.5804	-1.0316	-1.8802	27.8946	-2.3298	-257.6301	26.7834	-5.8064	-251.5307
	4.064	27.3828	-4.0418	-255.8787	-1.0066	-1.8843	27.978	-2.2057	-258.9292	26.7875	-5.8779	-252.8282
	4.08	27.0147	-4.0259	-256.8564	-1.1069	-1.6536	27.1411	-2.5025	-259.9116	26.8883	-5.5492	-253.8013
	4.096	26.982	-4.271	-257.5186	-1.0759	-1.6425	27.089	-2.7822	-260.2844	26.8751	-5.7598	-254.7528
	4.112	26.3329	-4.1732	-258.8144	-1.0789	-1.285	25.8273	-2.4523	-262.1616	26.8385	-5.8941	-255.4672
	4.128	26.1497	-3.3454	-259.629	-0.9844	-1.4239	25.9112	-1.7342	-262.0806	26.3881	-4.9565	-257.1774
	4.144	26.125	-3.5467	-260.865	-1.0226	-1.5273	26.036	-1.5024	-264.2164	26.2141	-5.5911	-257.5137
	4.16	26.5519	-3.4768	-261.7395	-1.0091	-1.6859	26.7696	-1.5935	-264.7519	26.3341	-5.3601	-258.7271
	4.176	26.4439	-3.7876	-262.5946	-1.0301	-1.6712	26.6152	-2.0864	-265.4423	26.2725	-5.4889	-259.7469
	4.192	26.1374	-3.6795	-263.6628	-1.0408	-1.5308	26.0543	-1.5984	-267.2173	26.2206	-5.7605	-260.1083
	4.208	24.8734	-3.6427	-264.3911	-0.9787	-0.8253	23.2104	-1.8416	-268.0361	26.5364	-5.4438	-260.7461
	4.224	25.0132	-3.171	-265.7881	-0.9614	-0.835	23.4719	-1.4685	-269.0784	26.5546	-4.8735	-262.4979
	4.24	24.2595	-3.2979	-266.5742	-0.946	-0.7445	22.4993	-1.6762	-269.8931	26.0197	-4.9196	-263.2554
	4.256	24.1766	-3.6975	-267.8107	-0.9402	-0.7773	22.327	-1.8775	-271.3652	26.0262	-5.5174	-264.2562
	4.272	24.1214	-3.458	-268.8498	-0.9842	-0.8117	22.4857	-1.7339	-272.4254	25.7572	-5.1821	-265.2741
	4.288	23.7369	-3.7948	-269.6423	-0.9223	-0.6117	21.4508	-2.1911	-273.3269	26.023	-5.3985	-265.9578
	4.304	23.6304	-3.8866	-270.393	-0.9425	-0.6082	21.4792	-2.3889	-274.0009	25.7815	-5.3844	-266.7852
	4.32	23.404	-4.2454	-271.7099	-0.943	-0.5256	21.1199	-2.9205	-275.3487	25.6882	-5.5703	-268.0711
	4.336	23.4071	-4.5781	-272.2385	-0.9396	-0.408	20.9871	-3.532	-275.8451	25.8271	-5.6242	-268.632

Man2											
time	pos(x)	pos(y)	pos(z)	el	az	x1	y1	z1	x2	y2	z2
4.352	23.0477	-4.7283	-273.084	-0.9733	-0.3307	20.918	-3.9972	-276.3933	25.1774	-5.4595	-269.7747
4.368	23.4254	-5.17	-273.707	-0.9842	-0.2464	21.3783	-4.6552	-276.8828	25.4725	-5.6848	-270.5311
4.384	23.1144	-5.7087	-274.083	-0.9667	-0.1261	20.9757	-5.4376	-277.2064	25.2531	-5.9799	-270.9595
4.4	23.1247	-5.9764	-274.9224	-0.892	0.0444	20.8386	-6.078	-277.7591	25.4109	-5.8748	-272.0857
4.416	23.0086	-6.2202	-275.5539	-0.8652	-0.0206	20.5561	-6.1698	-278.4334	25.461	-6.2707	-272.6745
4.432	22.5499	-6.4033	-276.3763	-0.9363	0.1845	20.7849	-6.7326	-278.8159	24.3149	-6.074	-273.9367

Manta 3											
time	pos(x)	pos(y)	pos(z)	el	az	x1	y1	z1	x2	y2	z2
0	0	0	0	-0.0621	0.0627	-3.4601	-0.2173	-0.2156	3.4601	0.2173	0.2156
0.016	1.2104	0.8197	-3.2389	0.779	0.0312	-0.8138	0.7565	-1.2396	3.2346	0.8828	-5.2382
0.032	0.8594	0.8876	-6.9118	0.9647	2.1885	1.4384	0.0726	-5.4694	0.2804	1.7025	-8.3542
0.048	1.2496	1.332	-10.8051	1.1642	1.5826	1.2589	0.5481	-8.9847	1.2403	2.1158	-12.6254
0.064	1.8087	0.8518	-14.5541	1.512	1.8652	1.8494	0.7176	-12.1732	1.768	0.986	-16.9349
0.08	2.0285	1.3027	-17.6877	1.0517	2.7386	3.0779	0.8553	-15.6909	0.979	1.7501	-19.6846
0.096	3.028	1.0433	-20.6521	1.1859	2.8634	3.8527	0.8078	-18.5347	2.2033	1.2788	-22.7694
0.112	2.3959	1.4165	-22.106	1.3084	1.8712	2.5412	0.9477	-20.279	2.2507	1.8852	-23.933
0.128	2.4556	0.8714	-25.5309	1.1764	2.7712	3.2997	0.5436	-23.3554	1.6116	1.1992	-27.7063
0.144	2.4585	1.0023	-27.0631	1.1097	2.8212	3.3241	0.7151	-25.2277	1.593	1.2895	-28.8985
0.16	3.1894	1.3763	-28.0393	1.3103	2.8371	3.7307	1.2062	-25.9104	2.6481	1.5464	-30.1682
0.176	3.2146	1.1682	-29.6455	1.3836	2.6632	3.5188	1.0104	-27.8367	2.9103	1.3259	-31.4543
0.192	3.2025	1.1639	-30.2948	1.3782	1.5225	3.1821	0.7429	-28.1336	3.2228	1.5849	-32.4561
0.208	4.1426	0.8859	-31.101	0.8575	0.4548	2.8098	0.234	-29.3862	5.4755	1.5377	-32.8157
0.224	3.9353	0.9512	-31.8307	1.1271	0.5607	3.1515	0.4591	-29.884	4.719	1.4433	-33.7775
0.24	5.5885	0.6946	-33.2386	0.7188	0.1337	3.5689	0.4231	-31.4557	7.6081	0.9662	-35.0215
0.256	5.5113	0.3828	-34.2504	0.8308	0.1119	3.7742	0.1877	-32.3361	7.2484	0.5779	-36.1647
0.272	6.0756	0.2313	-34.1435	0.6209	-0.0174	3.8149	0.2705	-32.5265	8.3362	0.192	-35.7606
0.288	6.457	0.639	-34.2613	0.6448	0.0311	4.4205	0.5756	-32.729	8.4936	0.7024	-35.7937
0.304	7.099	0.4847	-35.3976	0.6441	-0.1526	4.5906	0.8704	-33.4918	9.6073	0.099	-37.3035
0.32	7.1931	0.896	-35.5807	0.5097	-0.1497	4.5202	1.299	-34.0697	9.866	0.4929	-37.0916
0.336	7.4865	0.582	-36.1659	0.4838	-0.2001	4.2831	1.2319	-34.4484	10.6898	-0.0678	-37.8833
0.352	7.1012	0.0172	-36.5471	0.4571	-0.1412	3.6094	0.5136	-34.8126	10.5929	-0.4792	-38.2816
0.368	7.2208	0.3795	-37.5755	0.3784	-0.1077	3.34	0.7991	-36.0238	11.1017	-0.0401	-39.1273
0.384	7.5439	-0.4168	-38.1898	0.4093	-0.0259	4.8172	-0.3462	-37.0065	10.2707	-0.4874	-39.3732
0.4	7.1528	-0.5015	-39.1339	0.3222	0.0133	4.4965	-0.5368	-38.2471	9.8091	-0.4663	-40.0207
0.416	7.1093	-0.6757	-39.9515	0.3297	0.0265	4.854	-0.7355	-39.1796	9.3647	-0.616	-40.7234
0.432	7.423	-0.9265	-40.7479	0.3618	-0.0592	5.489	-0.8119	-40.0147	9.3569	-1.0411	-41.4811
0.448	7.3711	-0.9818	-41.2304	0.5969	-0.216	5.6186	-0.5973	-40.0112	9.1235	-1.3663	-42.4497
0.464	6.9055	-0.7096	-42.5344	0.7047	-0.2191	5.2275	-0.3359	-41.0727	8.5834	-1.0832	-43.9961
0.48	6.4422	-0.9291	-43.348	0.6504	-0.4284	4.8822	-0.2166	-42.0431	8.0022	-1.6416	-44.6529
0.496	6.917	-0.9923	-45.0093	0.5344	-0.1913	4.8612	-0.5942	-43.7699	8.9728	-1.3904	-46.2487
0.512	6.4158	-0.7793	-45.5035	0.7359	-0.2165	4.5252	-0.3634	-43.7504	8.3065	-1.1952	-47.2566
0.528	6.9592	-0.9988	-46.2483	0.877	0.0833	5.6185	-1.1108	-44.6306	8.2999	-0.8868	-47.866
0.544	6.5497	-1.2203	-47.457	0.8242	-0.2067	4.9637	-0.8878	-45.7056	8.1358	-1.5529	-49.2084
0.56	6.7267	-0.9793	-49.2416	0.9242	-0.0797	5.3416	-0.8687	-47.4009	8.1118	-1.0899	-51.0824
0.576	6.0637	-1.5544	-50.8629	0.9642	-0.1569	4.7954	-1.3538	-49.0125	7.332	-1.7551	-52.7133
0.592	5.6771	-0.8326	-50.6995	1.3821	-1.108	5.5013	-0.4802	-48.6371	5.8529	-1.185	-52.762
0.608	4.9873	-0.3155	-51.333	1.4571	-2.6604	5.2128	-0.1977	-49.1046	4.7618	-0.4332	-53.5613
0.624	5.2928	0.4634	-51.7113	1.356	-2.4422	5.6918	0.799	-49.3217	4.8938	0.1277	-54.1008
0.64	4.4801	0.2965	-53.0839	1.3747	-2.6283	4.8817	0.5229	-50.7629	4.0784	0.0701	-55.4049
0.656	4.1874	-0.2627	-54.6036	1.4805	-2.6818	4.3886	-0.163	-52.1235	3.9862	-0.3623	-57.0838
0.672	3.7383	-0.2812	-55.6213	1.3453	2.3199	4.1219	-0.6936	-53.1662	3.3548	0.1312	-58.0763
0.688	3.832	-0.4406	-56.7611	1.175	2.7013	4.6625	-0.8319	-54.5641	3.0016	-0.0493	-58.9581
0.704	3.7043	-0.4047	-57.4197	1.2177	2.8627	4.5234	-0.6392	-55.1078	2.8853	-0.1701	-59.7316
0.72	3.3082	-0.1673	-58.6181	1.3339	2.7919	3.879	-0.3755	-56.1009	2.7373	0.0408	-61.1352
0.736	2.9649	-0.7879	-60.1469	1.1766	2.7849	3.8708	-1.1255	-57.8225	2.059	-0.4503	-62.4712
0.752	2.3764	-0.623	-61.2283	1.2037	2.9044	3.2508	-0.8344	-58.8889	1.502	-0.4116	-63.5677
0.768	2.1624	-0.4963	-62.2441	1.402	2.5662	2.5225	-0.7298	-59.7262	1.8024	-0.2628	-64.7619
0.784	1.1132	-0.2745	-62.806	0.8042	3.0572	3.2378	-0.4542	-60.5919	-1.0115	-0.0948	-65.02
0.8	0.4708	-0.0918	-63.7779	0.7873	3.061	2.5163	-0.257	-61.7179	-1.5747	0.0734	-65.8378
0.816	0.3629	-0.2363	-64.6109	0.7512	3.035	2.2207	-0.435	-62.8661	-1.4949	-0.0376	-66.3557
0.832	-0.3324	-0.245	-65.4956	0.8438	-3.1303	1.3847	-0.2256	-63.5651	-2.0495	-0.2645	-67.426
0.848	-0.2228	0.2046	-66.3788	0.9075	-3.0655	1.5198	0.3375	-64.1423	-1.9654	0.0717	-68.6154
0.864	-0.7178	0.422	-66.7393	0.8366	3.0853	0.9401	0.3286	-64.8995	-2.3758	0.5154	-68.5791
0.88	-0.1042	0.077	-67.5206	0.9183	3.0993	1.7785	0.0062	-65.3275	-1.57	0.1479	-69.7136

Man3	time	pos(x)	pos(y)	pos(z)	el	az	x1	y1	z1	x2	y2	z2
	0.896	-0.9715	-0.0475	-68.8132	0.9638	-3.0862	0.5304	0.0359	-66.647	-2.4734	-0.1308	-70.9793
	0.912	-1.3718	1.0036	-68.9942	0.9663	-2.8496	0.1711	1.4674	-66.6618	-2.9148	0.5399	-71.3265
	0.928	-1.4029	0.6977	-70.1693	0.7046	3.1119	0.5327	0.6403	-68.523	-3.3385	0.7551	-71.8155
	0.944	-1.2197	0.1441	-71.5035	0.6675	3.0982	1.2989	0.0347	-69.5163	-3.7382	0.2535	-73.4907
	0.96	-1.0189	0.2436	-72.6232	0.7687	3.136	0.9815	0.2324	-70.6885	-3.0193	0.2548	-74.558
	0.976	-1.9964	0.6637	-73.468	0.788	-2.9283	0.073	1.1119	-71.3397	-4.0658	0.2155	-75.5963
	0.992	-1.9307	0.9554	-74.0382	0.8327	-2.949	-0.1113	1.3103	-72.0001	-3.7501	0.6006	-76.0762
	1.008	-2.2341	0.9943	-75.2435	0.523	3.0322	-0.0768	0.7573	-73.9923	-4.3914	1.2313	-76.4947
	1.024	-2.3767	1.0824	-76.0098	0.7893	-3.1355	-0.5981	1.0932	-74.2173	-4.1553	1.0716	-77.8024
	1.04	-2.9178	0.7034	-77.7411	0.854	3.0806	-1.2989	0.6046	-75.8798	-4.5366	0.8022	-79.6024
	1.056	-2.1585	0.5467	-79.0271	0.8016	3.0563	-0.2772	0.3858	-77.0767	-4.0397	0.7075	-80.9776
	1.072	-2.0651	1.0002	-80.3927	0.9159	-2.9737	-0.2838	1.3022	-78.04	-3.8464	0.6982	-82.7454
	1.088	-2.9737	2.3965	-80.1877	0.7106	2.858	-1.1744	1.8721	-78.5749	-4.7729	2.9209	-81.8006
	1.104	-2.9737	2.4652	-81.3562	0.6582	2.7965	-0.7869	1.7781	-79.7859	-4.6093	3.1522	-82.9265
	1.12	-1.8095	3.0402	-82.6749	0.8666	2.2986	-0.8232	1.9333	-80.9296	-2.7958	4.147	-84.4201
	1.136	-2.0956	4.0569	-83.5625	0.675	2.4097	-0.6412	2.7504	-81.9976	-3.5501	5.3634	-85.1273
	1.152	-1.8487	3.3693	-85.3975	0.9832	2.5114	-0.7435	2.5631	-83.3436	-2.9539	4.1754	-87.4514
	1.168	-2.2461	3.3181	-85.9954	0.8096	2.5512	-0.7439	2.3115	-84.0975	-3.7483	4.3247	-87.8933
	1.184	-0.8007	3.4252	-87.3513	1.1758	1.6813	-0.6954	2.4766	-85.062	-0.9059	4.3738	-89.6406
	1.2	-1.4868	3.4947	-88.1111	1.0983	1.998	-0.9974	2.4196	-85.8001	-1.9762	4.5698	-90.422
	1.216	-0.7899	3.8234	-89.0302	1.3029	1.2189	-1.0462	3.1254	-86.3216	-0.5336	4.5214	-91.7389
	1.232	-0.4447	3.8642	-90.6834	1.2242	1.7655	-0.2765	3.0108	-88.2753	-0.613	4.7176	-93.0914
	1.248	-0.0156	3.5693	-91.4235	1.1763	1.671	0.09	2.5191	-88.888	-0.1211	4.6195	-93.9591
	1.264	0.3183	3.9152	-92.1979	1.2844	1.0353	-0.0738	3.2543	-89.5888	0.7103	4.5761	-94.807
	1.28	0.8402	3.2977	-93.7471	1.2062	0.0928	-0.1217	3.2082	-91.2158	1.8021	3.3872	-96.2785
	1.296	1.0723	2.8638	-94.2282	1.2513	-0.1451	0.1539	2.9981	-91.4225	1.9907	2.7296	-97.0339
	1.312	1.348	2.7916	-95.5624	0.8922	-0.3042	-0.6319	3.4131	-92.9889	3.3278	2.17	-98.1359
	1.328	1.1313	3.0184	-96.4328	0.9046	-0.2641	-0.7769	3.5344	-93.9182	3.0395	2.5025	-98.9474
	1.344	0.9279	3.3047	-97.2455	0.9319	-0.2714	-0.6848	3.7534	-94.9917	2.5407	2.856	-99.4993
	1.36	2.875	3.0561	-98.3481	0.8825	-0.1531	0.8259	3.3723	-95.8272	4.9242	2.7399	-100.8689
	1.376	4.2101	2.7255	-99.8208	0.9692	-0.9704	3.5285	3.721	-98.0631	4.8918	1.73	-101.5785
	1.392	4.2276	3.1505	-100.7586	0.7407	-0.7319	2.9115	4.3328	-99.1409	5.5436	1.9683	-102.3762
	1.408	4.5926	2.9976	-101.2866	0.7238	-0.8647	3.6256	4.1316	-99.9692	5.5597	1.8635	-102.6039
	1.424	4.9367	3.1569	-102.2182	0.5075	-0.7925	3.6179	4.4946	-101.1737	6.2555	1.8193	-103.2628
	1.44	4.633	2.7203	-103.3021	0.7887	-1.4175	4.3983	4.2395	-101.7546	4.8678	1.201	-104.8495
	1.456	3.3659	1.8668	-103.7992	0.5863	-0.7629	1.9305	3.239	-102.4803	4.8012	0.4947	-105.1182
	1.472	3.4602	1.614	-104.939	0.6174	-0.8384	2.319	2.8832	-103.7272	4.6015	0.3448	-106.1509
	1.488	3.5762	1.7897	-106.0799	0.2881	-0.8705	1.835	3.8556	-105.2791	5.3174	-0.2762	-106.8806
	1.504	3.6222	1.9772	-106.7533	0.3728	-0.9206	2.1424	3.9231	-105.7972	5.102	0.0314	-107.7094
	1.52	4.5281	1.7845	-107.8848	0.4024	-1.1903	3.758	3.71	-107.0022	5.2982	-0.141	-108.7674
	1.536	4.2677	1.8106	-108.6807	0.3262	-0.9549	2.8702	3.7852	-107.8623	5.6652	-0.164	-109.4991
	1.552	4.0533	1.5608	-109.8012	0.3213	-0.8817	2.4991	3.4475	-108.9878	5.6074	-0.3258	-110.6146
	1.568	4.7666	1.2296	-111.9899	-0.0954	-0.8058	3.1531	2.9103	-112.2127	6.3801	-0.4511	-111.767
	1.584	4.763	1.3625	-113.6881	-0.0716	-0.9669	3.1526	3.6969	-113.8915	6.3734	-0.972	-113.4848
	1.6	5.2465	0.5867	-115.0409	-0.0032	-0.9868	3.4276	3.3388	-115.0514	7.0654	-2.1653	-115.0303
	1.616	5.5874	0.2582	-116.5782	-0.1327	-1.1402	4.3796	2.8878	-116.9646	6.7953	-2.3715	-116.1918
	1.632	6.5935	-0.5066	-118.0179	-0.1077	-0.8687	4.3329	2.1657	-118.3964	8.854	-3.1789	-117.6394
	1.648	6.3637	0.0773	-118.7401	-0.0711	-1.0653	4.8223	2.8622	-118.9667	7.9051	-2.7075	-118.5135
	1.664	6.3808	-0.2111	-121.1759	-0.1984	-1.0721	4.8754	2.5531	-121.8088	7.8863	-2.9753	-120.5431
	1.68	7.3645	-0.336	-122.6792	-0.1402	-1.0473	5.762	2.4401	-123.1317	8.967	-3.1122	-122.2267
	1.696	7.3439	-0.8341	-123.9907	-0.2583	-1.1373	6.2913	1.4403	-124.6527	8.3965	-3.1084	-123.3287
	1.712	7.6919	-1.0229	-125.5714	0.0535	-1.0648	5.8845	2.2387	-125.3716	9.4993	-4.2844	-125.7712
	1.728	8.3745	-1.2929	-126.6751	0.1608	-1.0888	6.917	1.4931	-126.165	9.832	-4.0789	-127.1851
	1.744	8.1309	-2.1497	-128.1022	0.1399	-1.0414	6.3495	0.8947	-127.6057	9.9124	-5.1941	-128.5988
	1.76	8.1445	-2.15	-130.2321	0.1472	-1.0544	6.5216	0.7083	-129.7449	9.7675	-5.0084	-130.7193
	1.776	8.5235	-2.1536	-132.2857	0.2277	-1.2063	7.4345	0.7008	-131.5778	9.6125	-5.0081	-132.9937
	1.792	8.5682	-2.5483	-134.2132	0.2671	-0.9948	7.018	-0.1614	-133.4343	10.1183	-4.9353	-134.992
	1.808	8.7054	-2.4561	-135.5137	0.5341	-1.163	7.8082	-0.3791	-134.1755	9.6027	-4.5332	-136.852
	1.824	8.8031	-2.9457	-137.2278	0.7788	-1.2207	7.9511	-0.6123	-134.7762	9.6551	-5.2791	-139.6794
	1.84	8.8452	-2.794	-138.7155	0.9144	-1.251	8.3021	-1.1543	-136.4731	9.3883	-4.4338	-140.9579
	1.856	10.8025	-3.2264	-141.3196	0.9587	-0.7076	9.3764	-2.0065	-138.6462	12.2286	-4.4463	-143.993
	1.872	9.3225	-3.216	-142.1216	1.1343	-0.866	8.3952	-2.1258	-139.0536	10.2497	-4.3062	-145.1896
	1.888	10.0017	-3.3264	-143.5907	1.3004	-0.9257	9.5392	-2.7118	-140.8156	10.4642	-3.941	-146.3658
	1.904	9.5706	-3.036	-145.2835	1.304	-2.631	10.1745	-2.6978	-142.751	8.9668	-3.3742	-147.816
	1.92	9.164	-2.688	-146.4679	1.2589	1.5224	9.1283	-3.4267	-144.174	9.1998	-1.9494	-148.7618
	1.936	9.1376	-1.9464	-147.5378	1.23	1.7642	9.3157	-2.8562	-144.9234	8.9595	-1.0366	-150.1523

Man3	time	pos(x)	pos(y)	pos(z)	el	az	x1	y1	z1	x2	y2	z2
	1.952	8.5029	-1.099	-147.9522	0.9911	2.1092	9.1995	-2.2652	-145.8775	7.8064	0.0672	-150.0269
	1.968	8.8447	-1.0983	-148.6699	1.0514	2.0687	9.3746	-2.0731	-146.7294	8.3148	-0.1235	-150.6103
	1.984	9.0332	-0.6069	-148.9347	0.6188	1.5606	9.0134	-2.5486	-147.5518	9.053	1.3348	-150.3176
	2	8.3883	-0.4632	-149.197	0.4562	1.836	8.8683	-2.2306	-148.2983	7.9083	1.3041	-150.0957
	2.016	8.1737	-0.26	-149.6686	0.4135	2.3032	9.2579	-1.4656	-148.957	7.0895	0.9456	-150.3801
	2.032	8.2704	-0.5133	-150.4056	0.3593	2.1631	8.9268	-1.4887	-149.964	7.6141	0.4621	-150.8472
	2.048	8.8075	-0.2518	-151.4513	0.3789	2.1716	9.4572	-1.2	-150.9936	8.1577	0.6964	-151.909
	2.064	8.7129	-0.8477	-152.6174	0.3783	2.1833	9.2543	-1.6182	-152.2431	8.1716	-0.0771	-152.9917
	2.08	8.9581	-0.972	-152.9054	0.0508	1.5346	8.9378	-1.5319	-152.8769	8.9784	-0.4121	-152.9339
	2.096	9.0726	-0.4645	-153.9985	0.1202	1.3991	8.9363	-1.251	-153.9021	9.209	0.3221	-154.0949
	2.112	9.5768	-1.0494	-155.2966	0.0277	1.6574	9.6339	-1.7074	-155.2782	9.5196	-0.3915	-155.3149
	2.128	9.5195	-0.8836	-156.5582	-0.0164	1.5216	9.4757	-1.7727	-156.5728	9.5633	0.0054	-156.5436
	2.144	9.9742	-0.5994	-158.1541	-0.4774	1.3392	9.8379	-1.1772	-158.4613	10.1104	-0.0215	-157.847
	2.16	9.5522	-0.212	-159.6018	0.1533	1.517	9.5196	-0.8188	-159.5079	9.5849	0.3948	-159.6958
	2.176	9.4725	-0.3748	-160.7818	-0.2942	1.613	9.5069	-1.1879	-161.0284	9.4382	0.4384	-160.5352
	2.192	9.566	-0.0243	-162.1479	-0.0396	1.5193	9.5163	-0.9901	-162.1863	9.6158	0.9414	-162.1096
	2.208	9.0948	0.9058	-163.4872	0.3067	1.6064	9.1323	-0.1463	-163.1538	9.0573	1.9579	-163.8206
	2.224	9.3531	0.337	-165.6477	0.1627	1.5255	9.3163	-0.4747	-165.5144	9.3899	1.1487	-165.7811
	2.24	9.1777	0.828	-167.2256	0.2092	1.2798	8.9706	-0.4088	-167.0723	9.3849	0.9745	-167.3789
	2.256	8.9758	1.5183	-168.342	0.1864	1.4727	8.8191	-0.0733	-168.0404	9.1325	3.11	-168.6437
	2.272	8.7945	1.4642	-169.8821	0.3184	1.6195	8.8426	0.4754	-169.5558	8.7463	2.453	-170.2084
	2.288	8.6257	2.0351	-171.5016	0.2144	1.6155	8.6743	0.9485	-171.2648	8.577	3.1216	-171.7385
	2.304	8.3418	1.5327	-173.2288	0.4427	1.7722	8.4948	0.783	-172.866	8.1888	2.2823	-173.5915
	2.32	8.5505	2.2195	-175.1007	0.3359	1.7288	8.6946	1.3146	-174.7808	8.4063	3.1244	-175.4206
	2.336	8.2115	2.4955	-176.7877	0.6848	1.2859	7.9973	1.7643	-176.1655	8.4256	3.2267	-177.4099
	2.352	8.0224	2.4956	-178.5244	1.0449	1.528	8.0007	1.987	-177.6474	8.0442	3.0041	-179.4013
	2.368	8.9419	2.4931	-180.7976	1.0564	1.5208	8.8986	1.628	-179.265	8.9852	3.3581	-182.3302
	2.384	8.2118	2.5743	-183.0135	1.2007	1.7494	8.3607	1.7497	-180.854	8.063	3.3989	-185.1731
	2.4	8.4326	3.402	-185.0024	1.2447	1.7489	8.5806	2.5799	-182.5323	8.2846	4.2242	-187.4725
	2.416	8.0354	2.5212	-186.6567	1.4842	-2.5226	8.2198	2.6526	-184.0473	7.851	2.3898	-189.2662
	2.432	9.1091	1.8646	-188.2246	1.5396	1.4636	9.099	1.7706	-185.1949	9.1192	1.9585	-191.2542
	2.448	9.5404	1.4127	-189.1973	1.2174	-0.9936	8.9447	2.3275	-186.2381	10.1361	0.4979	-192.1564
	2.464	10.4711	1.7578	-190.2016	1.2104	-0.7806	9.6901	2.5312	-187.2854	11.252	0.9844	-193.1178
	2.48	10.7093	1.532	-190.1869	0.8473	-0.9204	9.3618	3.3029	-187.6675	12.0568	-0.2389	-192.7062
	2.496	10.0295	1.1567	-191.305	0.718	-0.9326	8.2591	3.5435	-188.709	11.8	-1.2301	-193.9011
	2.512	10.4422	1.3522	-192.0649	0.4154	-1.0044	8.1241	4.9978	-190.1593	12.7603	-2.2933	-193.9706
	2.528	10.4122	0.7306	-192.2858	0.3623	-0.9719	8.0935	4.128	-190.7268	12.7309	-2.6668	-193.8447
	2.544	11.3595	0.7918	-192.8967	0.2834	-1.2536	10.1707	4.4134	-191.7867	12.5482	-2.8298	-194.0066
	2.56	10.8443	-0.2411	-193.4824	0.4044	-0.9914	8.4909	3.3558	-191.6427	13.1977	-3.8381	-195.3221
	2.576	11.0181	-0.4165	-194.4955	0.199	-1.0797	9.0434	3.2754	-193.6512	12.9927	-4.1085	-195.3399
	2.592	11.5649	0.3605	-195.5193	0.1938	-1.1152	10.1563	3.2354	-194.8912	12.9736	-2.5144	-196.1475
	2.608	11.1343	-0.251	-195.6061	0.0454	-0.9562	9.0253	2.7372	-195.4401	13.2432	-3.2391	-195.7721
	2.624	11.3057	-0.5611	-197.0228	-0.1642	-1.0672	9.5882	2.5564	-197.6124	13.0232	-3.6785	-196.4333
	2.64	12.5195	-0.8302	-198.3583	-0.1964	-1.0313	10.518	2.5128	-199.1336	14.521	-4.1731	-197.5583
	2.656	12.6321	-0.5602	-199.825	-0.2227	-0.9431	10.1959	2.7975	-200.7646	15.0682	-3.9179	-198.8854
	2.672	12.6357	-0.6949	-200.5321	-0.3248	-1.0447	10.725	2.5953	-201.8131	14.5465	-3.9851	-199.251
	2.688	12.9352	-1.4101	-202.1303	-0.3526	-1.0789	11.087	2.039	-203.5702	14.7833	-4.8592	-200.6904
	2.704	13.4959	-1.4376	-203.5122	-0.3438	-1.0655	11.9519	1.3537	-204.6541	15.0399	-4.2289	-202.3704
	2.72	13.1602	-1.8818	-204.8859	-0.2808	-1.0545	11.2343	1.5108	-206.0109	15.0861	-5.2743	-203.7608
	2.736	13.3857	-1.7125	-206.1127	-0.2258	-1.1637	12.1144	1.2359	-206.8501	14.6571	-4.6609	-205.3753
	2.752	14.2836	-2.2381	-207.2891	-0.2618	-1.0879	12.6488	0.8801	-208.2324	15.9184	-5.3562	-206.3459
	2.768	15.4636	-2.4874	-209.3125	-0.1889	-1.2257	14.2419	0.9118	-210.0031	16.6854	-5.8865	-208.6219
	2.784	15.8378	-2.9607	-210.8801	-0.2014	-1.1316	14.218	0.4873	-211.6579	17.4577	-6.4087	-210.1024
	2.8	15.7654	-3.0134	-212.7568	-0.2371	-1.2521	14.6049	0.5035	-213.6515	16.9259	-6.5302	-211.8621
	2.816	16.2485	-2.8737	-214.6829	-0.3425	-1.0885	14.8922	-0.283	-215.7256	17.6049	-5.4643	-213.6402
	2.832	16.0486	-3.4723	-216.2982	-0.2562	-1.1824	14.5861	0.1018	-217.3099	17.5111	-7.0463	-215.2865
	2.848	17.0316	-3.4298	-218.4265	-0.221	-0.9226	15.019	-0.7726	-219.1755	19.0441	-6.087	-217.6775
	2.864	16.9309	-4.2494	-219.7853	0.1244	-1.0466	14.992	-0.8957	-219.3009	18.8699	-7.6032	-220.2698
	2.88	16.7792	-2.8941	-221.1228	0.2932	-1.0985	15.2598	0.0804	-220.1142	18.2985	-5.8685	-222.1313
	2.896	16.9867	-3.5284	-223.7136	0.7033	-1.1517	16.1542	-1.6594	-221.9788	17.8192	-5.3974	-225.4484
	2.912	17.6938	-3.1014	-226.6386	0.7318	-0.8792	16.3622	-1.4931	-224.7632	19.0255	-4.7098	-228.5139
	2.928	17.0739	-3.3261	-227.8519	0.9238	-0.8664	15.8046	-1.8326	-225.2575	18.3432	-4.8197	-230.4462
	2.944	17.3809	-2.8929	-229.4712	0.8737	-0.968	16.2175	-1.2026	-227.0207	18.5443	-4.5832	-231.9218
	2.96	17.7964	-2.6895	-231.7202	1.4539	-1.1862	17.6618	-2.357	-228.6667	17.931	-3.0221	-234.7738
	2.976	17.0573	-1.8125	-233.0765	1.5618	1.5875	17.0578	-1.84	-230.006	17.0569	-1.7851	-236.147
	2.992	16.8437	-1.6996	-234.4867	1.3027	1.7089	16.9699	-2.6074	-231.1502	16.7175	-0.7917	-237.8232

Man3											
time	pos(x)	pos(y)	pos(z)	el	az	x1	y1	z1	x2	y2	z2
3.008	16.543	-0.8451	-235.6583	1.0437	1.623	16.6373	-2.6494	-232.5543	16.4488	0.9593	-238.7622
3.024	16.3536	-0.4763	-236.078	1.035	1.7855	16.7099	-2.1103	-233.261	15.9973	1.1578	-238.8949
3.04	17.2193	-0.0755	-237.0004	0.9558	1.6775	17.4272	-2.0155	-234.2382	17.0115	1.8646	-239.7626
3.056	16.5341	-0.4765	-237.124	0.9017	2.2593	17.3338	-1.4484	-235.5325	15.7344	0.4954	-238.7155
3.072	17.2714	-0.985	-237.2201	1.0005	2.432	17.711	-1.3625	-236.3165	16.8317	-0.6074	-238.1236
3.088	16.7242	-0.815	-238.5491	1.0595	2.9398	17.4164	-0.9566	-237.2898	16.032	-0.6735	-239.8084
3.104	17.2611	-0.3294	-238.8529	0.9423	1.5019	17.217	-0.9688	-237.9712	17.3053	0.31	-239.7346
3.12	17.5795	-0.6466	-239.4839	1.2608	1.9132	17.6235	-0.7702	-239.0743	17.5354	-0.523	-239.8935
3.136	18.124	-0.6195	-240.8884	0.7827	2.0459	18.3341	-1.0279	-240.4315	17.9138	-0.211	-241.3453
3.152	17.8389	-0.709	-241.495	0.8427	1.4185	17.7866	-1.0497	-241.1083	17.8912	-0.3682	-241.8817
3.168	17.5967	-0.6802	-242.658	1.3363	1.9368	17.6399	-0.793	-242.1525	17.5535	-0.5674	-243.1636
3.184	17.1683	-0.0317	-244.3892	0.9329	1.0573	16.9988	-0.3322	-243.9238	17.3378	0.2688	-244.8546
3.2	17.3233	0.3927	-245.8787	0.9712	1.3701	17.2575	0.0694	-245.3959	17.3891	0.716	-246.3614
3.216	17.1541	0.3442	-246.8833	0.482	1.0892	16.8898	-0.1615	-246.5848	17.4184	0.85	-247.1818
3.232	17.5538	-0.0816	-248.1503	0.6184	2.0254	17.7549	-0.4931	-247.8245	17.3527	0.3299	-248.4762
3.248	17.259	0.6404	-249.7647	1.1744	0.3	17.1399	0.6035	-249.4667	17.3782	0.6772	-250.0627
3.264	17.3868	0.5889	-251.1545	0.8854	1.3747	17.3346	0.3259	-250.8264	17.4391	0.8519	-251.4825
3.28	17.0687	0.9616	-252.6092	0.5561	1.3702	17.0051	0.6486	-252.4107	17.1324	1.2746	-252.8077
3.296	16.8505	0.6331	-253.8718	0.9179	0.8409	16.6064	0.3604	-253.3933	17.0945	0.9059	-254.3503
3.312	17.374	1.1967	-255.7183	1.0677	1.3291	17.2794	0.8127	-254.9996	17.4687	1.5807	-256.437
3.328	17.2007	1.3475	-258.0956	1.4177	1.4906	17.1871	1.178	-256.9938	17.2144	1.517	-259.1974
3.344	16.988	1.5901	-259.4675	1.3063	2.8868	17.241	1.5242	-258.502	16.735	1.656	-260.4329
3.36	17.4857	1.3893	-261.3535	1.3623	1.9611	17.5929	1.1287	-260.0214	17.3784	1.6499	-262.6856
3.376	17.5499	1.5791	-263.3507	1.4237	-2.5665	17.7045	1.6793	-262.1068	17.3952	1.4788	-264.5946
3.392	17.5838	1.6902	-265.0259	1.0852	-1.6064	17.6029	2.2253	-264.0113	17.5648	1.1551	-266.0405
3.408	17.12	1.7773	-266.719	1.1855	2.946	17.9001	1.6227	-264.758	16.3399	1.9318	-268.6801
3.424	17.6212	1.9674	-269.1335	1.2578	2.7369	18.3312	1.6632	-266.7468	16.9113	2.2715	-271.5203
3.44	18.4932	1.6165	-271.4147	1.3885	0.1962	17.8911	1.4968	-268.0847	19.0953	1.7362	-274.7447
3.456	18.342	1.1081	-272.4387	1.3524	-1.6593	18.3988	1.7478	-269.5444	18.2853	0.4684	-275.333
3.472	18.5956	0.4643	-273.0389	1.1562	-1.1359	18.1759	1.3678	-270.7756	19.0153	-0.4391	-275.3021
3.488	19.6174	0.5393	-273.8261	0.9161	-1.2252	19.0005	2.2528	-271.4536	20.2342	-1.1742	-276.1986
3.504	19.9327	0.0473	-274.3893	0.998	-1.3774	19.6427	1.5281	-272.0497	20.2227	-1.4335	-276.7289
3.52	20.0983	0.3813	-275.1535	0.9339	-1.4149	19.8543	1.9335	-273.0294	20.3422	-1.171	-277.2777
3.536	19.6558	0.8117	-275.8944	0.8427	-1.6457	19.7882	2.5751	-273.9109	19.5234	-0.9516	-277.8779
3.552	19.766	1.3593	-277.3004	0.885	-1.7451	20.0093	2.741	-275.5859	19.5226	-0.0224	-279.0149
3.568	20.2044	1.1318	-277.5377	0.6334	-1.6962	20.3825	2.5446	-276.492	20.0263	-0.2809	-278.5834
3.584	20.8482	0.4032	-277.6346	0.6364	-1.1393	20.0834	2.0641	-276.2833	21.613	-1.2577	-278.9858
3.6	21.5236	0.2538	-279.0975	0.6896	-1.3218	21.2165	1.4617	-278.0697	21.8308	-0.9541	-280.1253
3.616	22.4084	-0.8649	-278.8271	-0.0461	-1.5205	22.2799	1.6877	-278.9451	22.5369	-3.4175	-278.7091
3.632	22.1688	-0.746	-279.7237	-0.0408	-1.4907	21.9814	1.5894	-279.8194	22.3562	-3.0815	-279.628
3.648	23.3494	-0.2693	-281.3866	-0.199	-1.6031	23.4285	2.1797	-281.8807	23.2704	-2.7183	-280.8925
3.664	23.2864	-0.9932	-282.6001	-0.4212	-1.7636	23.7924	1.5993	-283.7836	22.7803	-3.5856	-281.4166
3.68	23.8779	-1.2503	-283.2669	-0.3974	-1.7072	24.2447	1.4217	-284.399	23.5112	-3.9224	-282.1349

Manta											
time	pos(x)	pos(y)	pos(z)	el	az	x1	y1	z1	x2	y2	z2
0	0	0	0	-0.3838	2.944	1.6699	-0.3343	-0.6877	-1.6699	0.3343	0.6877
0.016	0.3682	1.3339	-1.9991	-0.3557	1.4626	0.2291	0.0532	-2.4777	0.5073	2.6145	-1.5205
0.032	-0.9122	1.4457	-4.8989	0.126	1.6961	-0.7963	0.5248	-4.7813	-1.0282	2.3666	-5.0165
0.048	-1.3908	2.2051	-7.6038	-0.1637	1.8456	-1.1799	1.457	-7.7322	-1.6017	2.9532	-7.4754
0.064	-1.3525	2.3377	-9.8876	-0.8722	3.0645	-0.9152	2.3039	-10.4098	-1.7899	2.3715	-9.3653
0.08	-1.68	2.6515	-11.8977	-0.726	-1.7395	-1.481	3.8204	-12.9505	-1.8791	1.4826	-10.845
0.096	-1.7398	3.6136	-13.6127	-0.7109	-1.5903	-1.7167	4.8009	-14.6352	-1.7629	2.4263	-12.5902
0.112	-2.0819	3.5892	-14.8316	-0.9298	-1.736	-1.9275	4.5154	-16.0901	-2.2364	2.663	-13.573
0.128	-2.6083	4.9361	-15.6874	-1.0183	-1.7112	-2.4701	5.9139	-17.2893	-2.7465	3.9584	-14.0856
0.144	-2.5253	4.6435	-18.1202	-0.8484	-1.7339	-2.3313	5.8218	-19.4753	-2.7192	3.4651	-16.7651
0.16	-3.0598	4.6714	-18.6843	-0.8515	-2.1004	-2.4684	5.6818	-20.0212	-3.6513	3.661	-17.3474
0.176	-2.7806	4.4047	-19.0959	-0.5821	-1.515	-2.8579	5.7892	-20.0086	-2.7032	3.0202	-18.1831
0.192	-2.6924	4.1627	-20.5593	-0.4394	-1.0099	-3.5546	5.5351	-21.3211	-1.8301	2.7902	-19.7975
0.208	-2.7392	3.3578	-22.7503	-0.6225	-1.1117	-3.4353	4.7659	-23.8776	-2.0431	1.9497	-21.6231
0.224	-2.0915	3.6757	-23.5356	-0.8701	-1.951	-1.5548	5.0186	-25.2502	-2.6281	2.3328	-21.821
0.24	-0.9279	4.0444	-25.1978	-0.9371	-1.6329	-0.8485	5.3215	-26.9393	-1.0074	2.7674	-23.4564
0.256	-1.0295	3.525	-27.0563	-0.7371	-1.5827	-1.0123	4.9678	-28.3662	-1.0467	2.0821	-25.7464
0.272	-0.263	3.3909	-27.7496	-0.9586	-1.6353	-0.1928	4.4764	-29.2986	-0.3331	2.3055	-26.2006
0.288	0.4008	3.3667	-28.3184	-1.0278	-1.6342	0.4633	4.3505	-29.9518	0.3383	2.383	-26.6849

Man4	time	pos(x)	pos(y)	pos(z)	el	az	x1	y1	z1	x2	y2	z2
	0.304	0.8327	3.0976	-29.3248	-1.11	-1.2698	0.5856	3.8938	-31.004	1.0798	2.3015	-27.6456
	0.32	0.2526	3.4505	-30.0036	-1.0099	-1.0724	-0.3227	4.5077	-31.9195	0.8279	2.3934	-28.0877
	0.336	0.9938	3.3878	-30.8593	-1.1226	-1.8565	1.2348	4.2081	-32.6375	0.7529	2.5674	-29.0812
	0.352	0.0133	3.2725	-30.8627	-1.1093	-1.7907	0.2063	4.1361	-32.642	-0.1797	2.409	-29.0835
	0.368	0.917	3.6717	-31.0749	-1.1162	-2.2942	1.6629	4.5163	-33.3808	0.1711	2.827	-28.7691
	0.384	0.8723	3.0632	-32.3213	-1.1164	-2.4005	1.6959	3.8169	-34.6062	0.0488	2.3096	-30.0363
	0.4	1.6196	4.9823	-30.926	-1.3216	-2.599	2.1891	5.3257	-33.5385	1.0502	4.639	-28.3134
	0.416	1.2577	4.3993	-31.9264	-1.3039	-3.014	2.0759	4.5043	-34.944	0.4395	4.2943	-28.9089
	0.432	1.2339	3.9395	-33.1963	-1.1664	-2.7867	2.2418	4.3131	-35.7079	0.2259	3.566	-30.6847
	0.448	1.3959	3.639	-34.0818	-1.2926	-3.0732	2.1652	3.6917	-36.7819	0.6265	3.5863	-31.3816
	0.464	2.0659	3.3484	-34.9796	-1.4158	-2.8894	2.4601	3.45	-37.5853	1.6716	3.2468	-32.3739
	0.48	2.0589	3.1382	-35.7463	-1.2803	-2.9572	2.8191	3.28	-38.3324	1.2988	2.9964	-33.1602
	0.496	1.7935	2.5225	-36.6807	-1.5499	-1.2729	1.7756	2.5808	-39.6005	1.8114	2.4642	-33.7609
	0.512	1.9676	2.2251	-37.0327	-1.3815	2.2209	2.3284	1.7506	-40.144	1.6068	2.6996	-33.9215
	0.528	2.929	2.1805	-37.5812	-1.3773	2.7123	3.4276	1.9523	-40.3804	2.4303	2.4088	-34.7819
	0.544	2.9403	2.3771	-38.3107	-1.4185	-2.9113	3.3615	2.4758	-41.1286	2.5191	2.2783	-35.4928
	0.56	3.2642	1.8516	-39.535	-1.3848	2.7501	3.7547	1.6492	-42.3549	2.7738	2.0541	-36.7151
	0.576	3.7785	1.8058	-39.9798	-1.3003	3.0913	4.5893	1.7649	-42.9072	2.9676	1.8466	-37.0524
	0.592	3.6471	1.6888	-40.6301	-1.5064	-1.5918	3.6505	1.8521	-43.1613	3.6436	1.5256	-38.0989
	0.608	3.1329	2.4222	-41.5593	-1.3278	-2.6265	3.6299	2.7035	-43.863	2.6359	2.1409	-39.2556
	0.624	3.718	2.5123	-42.8669	-1.2968	-2.8725	4.3308	2.6813	-45.1286	3.1053	2.3434	-40.6051
	0.64	3.8765	2.2162	-43.5293	-1.2553	-2.332	4.4015	2.7673	-45.861	3.3515	1.6651	-41.1976
	0.656	4.4965	2.1308	-45.3008	-1.3697	-2.7878	4.9834	1.9509	-47.8473	4.0095	2.3106	-42.7544
	0.672	3.8652	2.012	-45.3277	-1.2617	-2.6718	4.5253	2.3472	-47.6458	3.2052	1.6769	-43.0095
	0.688	4.1511	1.7393	-45.9631	-1.3237	3.1209	4.8863	1.724	-48.878	3.4158	1.7545	-43.0483
	0.704	5.043	1.6612	-46.438	-1.4228	2.7846	5.418	1.5213	-49.1223	4.6679	1.8011	-43.7537
	0.72	5.1463	1.3139	-46.8627	-1.41	3.0793	5.5816	1.2867	-49.551	4.711	1.341	-44.1743
	0.736	5.8465	1.1913	-47.7973	-1.3711	-2.9834	6.3599	1.2732	-50.3663	5.333	1.1094	-45.2283
	0.752	6.4955	1.2985	-48.7023	-1.5484	-2.8852	6.5519	1.3134	-51.3066	6.439	1.2837	-46.098
	0.768	5.9575	1.696	-48.8022	-1.2698	-3.0889	6.7281	1.7367	-51.2874	5.187	1.6554	-46.3169
	0.784	6.461	1.3365	-49.8966	-1.3324	-3.0275	7.1065	1.4105	-52.5707	5.8154	1.2625	-47.2226
	0.8	6.9701	1.3176	-50.627	-1.2236	-2.8483	7.881	1.5927	-53.2569	6.0592	1.0425	-47.997
	0.816	6.9168	1.2792	-51.2157	-1.1506	3.1397	8.2811	1.2766	-54.269	5.5525	1.2818	-48.1623
	0.832	7.6563	1.3989	-52.4195	-1.4307	3.0121	8.0416	1.3487	-55.1745	7.2711	1.449	-49.6644
	0.848	8.4039	1.5465	-52.65	-1.2809	3.0435	9.1392	1.4742	-55.1267	7.6686	1.6188	-50.1733
	0.864	7.6657	1.8129	-53.1045	-1.0746	3.0554	9.1052	1.6885	-55.7733	6.2262	1.9373	-50.4357
	0.88	8.2996	2.2964	-53.5939	-1.2842	2.7842	8.9566	2.0511	-55.9732	7.6427	2.5418	-51.2146
	0.896	8.2845	1.7249	-54.4066	-1.172	2.8234	9.4529	1.34	-57.3258	7.116	2.1098	-51.4875
	0.912	9.3422	1.5195	-55.3236	-1.3352	2.6318	9.9333	1.189	-58.1444	8.7512	1.8499	-52.5028
	0.928	9.1718	1.8828	-56.0911	-1.3445	3.0366	8.8096	1.8156	-58.8765	8.5339	1.95	-53.3056
	0.944	8.755	2.0619	-56.5408	-1.2073	-2.886	9.7865	2.3314	-59.3437	7.7236	1.7924	-53.7379
	0.96	9.4071	1.8289	-56.9221	-1.1708	2.8285	10.4637	1.4869	-59.5484	8.3506	2.1709	-54.2959
	0.976	9.787	2.1279	-57.9719	-1.133	2.6432	10.8591	1.5445	-60.5795	8.7149	2.7113	-55.3642
	0.992	10.1418	1.59	-59.1691	-1.0766	3.0857	11.4401	1.5173	-61.5826	8.8435	1.6627	-56.7555
	1.008	10.2558	1.7016	-59.5389	-0.9956	3.0807	11.7745	1.609	-61.886	8.7371	1.7941	-57.1918
	1.024	11.528	1.2983	-60.4945	-1.1171	-3.1271	12.6516	1.3147	-62.7991	10.4044	1.282	-58.1899
	1.04	11.8399	1.3429	-60.9177	-1.0898	-2.9776	12.8844	1.5158	-62.9462	10.7953	1.1701	-58.8893
	1.056	11.4684	1.3659	-61.8172	-0.9548	-2.9481	12.9856	1.6632	-64.0011	9.9513	1.0686	-59.6333
	1.072	11.8311	1.65	-62.3914	-0.8591	-3.0939	13.4992	1.7296	-64.3276	10.163	1.5704	-60.4552
	1.088	12.0258	2.0304	-62.7355	-0.8429	-3.0819	13.8579	2.1399	-64.7949	10.1937	1.9209	-60.6761
	1.104	12.3736	1.7214	-63.8649	-0.78	-3.0664	14.4685	1.8792	-65.9434	10.2787	1.5636	-61.7864
	1.12	12.1393	1.8593	-63.9493	-0.8798	-3.0344	13.8996	2.0488	-66.0899	10.3789	1.6699	-61.8086
	1.136	12.3504	1.9089	-65.0726	-0.7868	-3.0321	13.9533	2.085	-66.6896	10.7475	1.7327	-63.4555
	1.152	13.1851	1.9438	-65.5164	-0.7822	-3.114	14.9833	1.9934	-67.304	11.3868	1.8943	-63.7288
	1.168	13.1123	1.7267	-66.2213	-1.0026	-3.0812	14.4831	1.8096	-68.3725	11.7414	1.6438	-64.0701
	1.184	13.2088	1.4752	-67.7463	-0.7283	-2.9815	14.8406	1.7388	-69.2205	11.577	1.2117	-66.272
	1.2	13.6419	1.5938	-67.9512	-0.7871	-3.0372	15.3327	1.7709	-69.6569	11.9511	1.4166	-66.2456
	1.216	15.0152	1.6424	-68.9355	-0.7287	-2.9089	16.6442	2.0283	-70.4298	13.3863	1.2564	-67.4412
	1.232	14.8283	1.5351	-69.5252	-0.6753	-2.9113	16.6242	1.9562	-71.0027	13.0323	1.114	-68.0476
	1.248	15.0107	1.7056	-70.2231	-0.6702	-2.9727	16.6241	1.9808	-71.5204	13.3973	1.4305	-68.9258
	1.264	14.9515	1.8717	-70.878	-0.5416	-2.9667	16.6932	2.1795	-71.9421	13.2098	1.564	-69.8138
	1.28	15.5064	1.7042	-71.698	-0.5246	-3.0507	17.6215	1.8971	-72.9269	13.3913	1.5114	-70.469
	1.296	15.973	1.998	-72.3415	-0.6895	-2.9384	17.4469	2.3016	-73.5822	14.4992	1.6943	-71.1008
	1.312	15.669	2.4038	-72.7662	-0.5681	-3.0985	18.0456	2.5062	-74.2847	13.2924	2.3014	-71.2478
	1.328	16.4226	2.212	-73.8741	-0.6869	-3.0518	18.2066	2.3726	-75.3433	14.6385	2.0514	-72.4049
	1.344	16.6336	2.4755	-74.3562	-0.7452	-3.0332	18.393	2.667	-75.9892	14.8743	2.284	-72.7232

Man4

time	pos(x)	pos(y)	pos(z)	el	az	x1	y1	z1	x2	y2	z2
1.36	16.1026	2.9324	-74.4944	-0.694	-2.9727	18.407	3.3253	-76.4394	13.7982	2.5395	-72.5494
1.376	16.1464	3.0766	-74.9957	-0.684	-2.9945	18.4869	3.4234	-76.9248	13.8058	2.7298	-73.0666
1.392	15.7277	3.2721	-75.5933	-0.7971	-2.9331	17.4627	3.6392	-77.4087	13.9927	2.905	-73.7779
1.408	16.1286	3.0407	-76.4037	-0.6825	-2.8813	18.4131	3.6492	-78.3252	13.8441	2.4322	-74.4822
1.424	15.8792	3.1547	-76.9607	-0.7518	-2.9297	18.0617	3.6241	-79.0481	13.6966	2.6853	-74.8734
1.44	15.9676	3.3289	-77.6328	-0.8102	-2.8164	17.7414	3.9269	-79.5999	14.1937	2.7309	-75.6657
1.456	15.9478	3.5197	-78.2927	-0.9153	-2.9863	17.8762	3.8216	-80.8313	14.0193	3.2178	-75.7541
1.472	16.3525	3.8048	-78.9188	-0.9278	-2.8307	17.9813	4.3281	-81.202	14.7238	3.2815	-76.6356
1.488	16.3555	3.3847	-80.1796	-0.9597	-2.4956	17.626	4.3425	-82.4506	15.0851	2.4269	-77.9086
1.504	15.7316	3.66	-80.4188	-0.9003	-2.5136	17.0012	4.5817	-82.3971	14.462	2.7383	-78.4406
1.52	16.0675	4.1704	-81.3332	-0.8371	-2.6554	17.57	4.9645	-83.2181	14.565	3.3763	-79.4484
1.536	14.9388	4.2653	-81.3029	-0.837	-2.5591	16.2858	5.1527	-83.0914	13.5919	3.378	-79.5143
1.552	15.6142	4.271	-82.2673	-0.9053	-2.5569	16.8398	5.0823	-84.1399	14.3885	3.4598	-80.3948
1.568	16.123	4.5946	-83.2073	-0.896	-2.5024	17.4051	5.5477	-85.204	14.8409	3.6415	-81.2107
1.584	15.732	4.9175	-83.4941	-0.8761	-2.4845	17.0368	5.9242	-85.472	14.4271	3.9108	-81.5162
1.6	14.8749	5.1779	-84.2915	-0.814	-2.5774	16.3752	6.1273	-86.1717	13.3745	4.2285	-82.4113
1.616	15.7983	5.017	-85.3516	-0.9637	-2.4037	16.9104	6.0282	-87.5156	14.6862	4.0057	-83.1875
1.632	14.9391	4.978	-86.2611	-0.8144	-1.7946	15.2553	6.3674	-87.7712	14.6228	3.5885	-84.751
1.648	14.5917	5.7615	-86.5188	-0.9874	-1.934	15.0394	6.9393	-88.4277	14.144	4.5838	-84.6099
1.664	14.348	5.9234	-87.0285	-0.8422	-2.0799	15.0918	7.2559	-88.7386	13.6042	4.5909	-85.3183
1.68	14.9168	5.7709	-87.8478	-0.7929	-2.0396	15.6542	7.227	-89.5048	14.1794	4.3148	-86.1908
1.696	14.5247	6.3473	-88.3837	-0.8972	-2.1687	15.3629	7.578	-90.2495	13.6866	5.1166	-86.5179
1.712	15.1694	6.6989	-89.2123	-1.0094	-1.8215	15.5059	8.013	-91.369	14.8329	5.3848	-87.0556
1.728	14.731	6.2433	-89.9183	-0.9658	-1.3608	14.454	7.5428	-91.8399	15.008	4.9437	-87.9966
1.744	14.5201	6.6135	-90.7015	-0.9441	-1.6158	14.5808	7.9623	-92.5662	14.4594	5.2646	-88.8367
1.76	14.2498	6.1759	-91.9642	-0.8643	-1.7286	14.5135	7.8328	-93.9299	13.9861	4.519	-89.9985
1.776	14.3453	6.1153	-93.0867	-0.9452	-1.4108	14.1337	7.4264	-94.9253	14.5568	4.8041	-91.2481
1.792	14.3835	6.0467	-94.0866	-0.8071	-1.4707	14.205	7.8248	-95.953	14.5621	4.2685	-92.2202
1.808	14.1224	6.2521	-94.4141	-0.6904	-1.2001	13.3871	8.1442	-96.091	14.8576	4.36	-92.7372
1.824	14.0619	6.5238	-95.4907	-0.7397	-1.1758	13.3501	8.2313	-97.1788	14.7738	4.8163	-93.8026
1.84	14.0905	6.4071	-96.3639	-0.7419	-1.0373	13.1696	7.9663	-98.0237	15.0115	4.848	-94.7041
1.856	13.9446	6.236	-97.5017	-0.7832	-0.975	12.8063	7.9151	-99.5214	15.0829	4.5569	-95.482
1.872	13.7774	6.474	-98.2669	-0.7435	-0.8173	12.4339	7.9062	-100.0726	15.1209	5.0418	-96.4613
1.888	13.1518	6.1787	-99.2522	-0.6814	-0.8638	11.6561	7.9294	-101.1196	14.6475	4.4281	-97.3849
1.904	13.471	5.945	-100.0769	-0.7007	-0.8375	12.2841	7.2626	-101.5726	14.6578	4.6274	-98.5813
1.92	13.7061	6.0275	-101.0778	-0.7498	-0.8833	12.4304	7.581	-102.9498	14.9817	4.4739	-99.2058
1.936	13.5809	6.0167	-102.2787	-0.7681	-0.7333	12.1354	7.3189	-104.1581	15.0264	4.7146	-100.3994
1.952	13.8524	5.6473	-103.4023	-0.9152	-0.6452	12.4845	6.6769	-105.6282	15.2203	4.6177	-101.1763
1.968	14.0799	5.4386	-104.375	-0.8595	-0.8125	12.8486	6.7386	-106.4525	15.3111	4.1386	-102.2974
1.984	13.5957	4.8984	-105.4031	-0.9282	-0.5822	12.2533	5.7822	-107.55	14.9382	4.0146	-103.2561
2	13.7188	5.222	-105.9699	-0.8698	-0.7639	12.5016	6.3879	-107.9672	14.9361	4.056	-103.9726
2.016	13.7392	5.1057	-106.8407	-0.9038	-0.4874	12.3039	5.8664	-108.9038	15.1746	4.3449	-104.7776
2.032	13.8521	4.357	-108.4701	-0.9726	-0.0702	12.3054	4.4657	-110.7452	15.3987	4.2484	-106.195
2.048	13.6357	4.1811	-109.273	-1.063	-0.1777	12.3142	4.4184	-111.6856	14.9571	3.9438	-106.8603
2.064	14.464	3.8768	-110.6502	-0.9915	-0.119	12.9739	4.0549	-112.9444	15.954	3.6987	-108.356
2.08	14.1965	3.6256	-111.1506	-1.0299	-0.0259	12.759	3.6629	-113.5447	15.634	3.5883	-108.7566
2.096	13.5429	3.5924	-111.8867	-0.9886	-0.0492	12.0385	3.6666	-114.1748	15.0473	3.5183	-109.5986
2.112	14.3412	3.2282	-112.7702	-1.0252	0.052	12.9213	3.1542	-115.1124	15.7612	3.3021	-110.428
2.128	14.596	2.8814	-113.7721	-1.0344	0.1504	13.052	2.6473	-116.3987	16.1399	3.1154	-111.1456
2.144	14.1116	2.4816	-114.4574	-1.1214	0.2742	12.8276	2.1204	-117.2231	15.3956	2.8428	-111.6917
2.16	14.6439	1.9268	-115.8082	-0.9713	0.384	12.9727	1.2516	-118.4458	16.3152	2.602	-113.1707
2.176	14.6566	1.4913	-116.1498	-0.9874	0.0964	13.1095	1.3417	-118.5046	16.2037	1.6409	-113.7951
2.192	15.1862	1.2535	-117.3351	-1.1416	0.252	13.9541	0.9363	-120.1152	16.4182	1.5707	-114.555
2.208	15.7164	0.9766	-118.0308	-1.1648	0.527	14.6618	0.3629	-120.8696	16.7711	1.5903	-115.192
2.224	15.6342	0.8696	-119.563	-0.9994	0.2915	13.8295	0.3282	-122.4937	17.439	1.4111	-116.6323
2.24	16.9204	0.2084	-120.443	-1.0519	0.4845	15.5957	-0.4888	-123.0645	18.2452	0.9056	-117.8216
2.256	17.0916	0.2748	-120.6009	-1.064	0.5541	15.7475	-0.5569	-123.4478	18.4357	1.1066	-117.754
2.272	17.5537	0.1725	-121.6867	-1.0961	0.6234	16.2596	-0.758	-124.788	18.8477	1.103	-118.5855
2.288	17.1783	-0.2969	-122.4626	-0.926	0.3895	15.2596	-1.0844	-125.2204	19.0971	0.4906	-119.7049
2.304	18.1624	-0.5406	-123.2384	-1.0321	0.6668	16.8475	-1.5754	-126.0381	19.4773	0.4942	-120.4386
2.32	17.9351	-0.9518	-123.7721	-1.0282	0.5802	16.4245	-1.9419	-126.7673	19.4457	0.0382	-120.7769
2.336	18.1395	-1.4194	-124.6894	-1.095	0.8428	17.0741	-2.6146	-127.7963	19.2049	-0.2243	-121.5825
2.352	18.7683	-1.2395	-125.4949	-1.1441	1.2082	18.2849	-2.5134	-128.4924	19.2517	0.0345	-122.4975
2.368	18.7799	-1.8006	-126.2119	-1.116	0.936	17.8941	-3.0033	-129.2667	19.6656	-0.598	-123.1571
2.384	19.0474	-1.9739	-126.6331	-1.0308	1.0588	18.2032	-3.4761	-129.5077	19.8915	-0.4716	-123.7585
2.4	20.2105	-2.578	-127.3368	-1.0768	0.8627	19.1981	-3.7603	-130.2269	21.2229	-1.3956	-124.4467

Man4

time	pos(x)	pos(y)	pos(z)	el	az	x1	y1	z1	x2	y2	z2
2.416	20.1432	-2.3773	-127.8121	-1.2082	1.0517	19.5763	-3.3695	-130.8243	20.7101	-1.3851	-124.7999
2.432	20.1527	-3.3006	-129.0639	-1.13	1.3934	19.9085	-4.6629	-131.9979	20.3969	-1.9383	-126.13
2.448	20.6796	-3.1004	-129.673	-1.1371	1.515	20.5999	-4.528	-132.7607	20.7594	-1.6728	-126.5853
2.464	20.7407	-3.0313	-130.3465	-1.1708	1.2487	20.3432	-4.2225	-133.317	21.1383	-1.8401	-127.3759
2.48	21.3205	-2.6547	-131.0434	-1.0929	1.4878	21.1835	-4.3026	-134.2358	21.4576	-1.0068	-127.8511
2.496	21.86	-3.2012	-132.072	-1.1442	1.4495	21.6913	-4.5851	-135.1391	22.0287	-1.8173	-129.0049
2.512	22.2201	-3.0444	-132.6489	-1.0937	1.6386	22.3332	-4.7102	-135.8788	22.1069	-1.3786	-129.4189
2.528	22.5051	-3.4958	-133.5077	-1.2283	1.2829	22.1976	-4.5345	-136.5461	22.8127	-2.4571	-130.4693
2.544	22.8175	-3.2718	-134.3037	-1.1917	1.1964	22.3941	-4.3491	-137.2097	23.2408	-2.1945	-131.3977
2.56	23.2951	-3.5633	-135.2005	-1.128	1.5034	23.2022	-4.9407	-138.1121	23.3881	-2.1858	-132.289
2.576	23.0592	-3.9417	-135.7453	-1.1413	1.6154	23.1223	-5.3543	-138.8328	22.9961	-2.5291	-132.6577
2.592	23.893	-3.5599	-136.5093	-1.2969	1.4844	23.8228	-4.3697	-139.4024	23.9632	-2.7501	-133.6162
2.608	24.2286	-3.6626	-136.7489	-1.2687	1.3443	24.016	-4.5852	-139.7871	24.4413	-2.7399	-133.7106
2.624	24.5668	-3.9572	-138.1451	-1.2452	1.5004	24.4883	-5.0711	-141.453	24.6453	-2.8434	-134.8372
2.64	24.4419	-4.4446	-138.8418	-1.3595	1.1093	24.1346	-5.0625	-142.0599	24.7492	-3.8266	-135.6236
2.656	24.9949	-4.4374	-139.7975	-1.2288	1.9842	25.452	-5.4792	-142.9932	24.5378	-3.3956	-136.6018
2.672	25.6819	-4.5135	-140.6326	-1.2489	1.6605	25.7832	-5.641	-144.0266	25.5805	-3.3861	-137.2385
2.688	25.314	-4.161	-141.5685	-1.1754	2.2502	26.1894	-5.245	-144.9065	24.4385	-3.0769	-138.2304
2.704	25.7351	-4.2035	-142.3447	-1.0266	2.3198	27.1371	-5.7114	-145.747	24.3332	-2.6956	-138.9424
2.72	26.2978	-4.4691	-142.5069	-1.1669	2.1907	27.1415	-5.6511	-145.9043	25.4542	-3.2871	-139.1096
2.736	26.4903	-4.4143	-143.8009	-1.168	2.0665	27.1763	-5.6831	-147.1858	25.8042	-3.1456	-140.416
2.752	26.9922	-4.8359	-144.082	-1.1371	2.7319	28.4011	-5.4478	-147.3985	25.5832	-4.224	-140.7655
2.768	26.9531	-4.3669	-145.2428	-1.2502	2.44	27.8243	-5.1031	-148.678	26.0819	-3.6308	-141.8075
2.784	27.2206	-4.4371	-146.0421	-1.0653	2.856	28.7519	-4.8867	-148.9257	25.6893	-3.9875	-143.1586
2.8	27.049	-4.6043	-146.7175	-1.0475	2.7988	28.6567	-5.1781	-149.676	25.4413	-4.0306	-143.759
2.816	27.4331	-4.8845	-147.8173	-0.9828	2.9224	29.4846	-5.3414	-150.9701	25.3817	-4.4275	-144.6646
2.832	27.8506	-4.5614	-148.6527	-0.8571	2.8972	30.3855	-5.1935	-151.6693	25.3156	-3.9293	-145.636
2.848	28.4251	-4.8924	-149.2055	-0.9981	2.7909	30.0319	-5.4802	-151.8592	26.8183	-4.3047	-146.5518
2.864	27.34	-4.7543	-149.7073	-0.941	2.8104	29.0518	-5.3429	-152.1912	25.6282	-4.1656	-147.2234
2.88	28.361	-5.198	-150.7889	-0.8631	2.8748	30.4604	-5.7718	-153.3327	26.2616	-4.6242	-148.245
2.896	29.0884	-5.2695	-151.1188	-0.9874	3.0369	30.7672	-5.4458	-153.6765	27.4096	-5.0932	-148.5611
2.912	29.0739	-4.8262	-151.5904	-0.9838	2.8677	30.7843	-5.3067	-154.2615	27.3635	-4.3456	-148.9194
2.928	29.1171	-4.6891	-152.9619	-0.8833	3.1207	31.291	-4.7346	-155.61	26.9432	-4.6437	-150.3137
2.944	29.5125	-4.0979	-153.8909	-0.8511	2.8567	31.6333	-4.7191	-156.4118	27.3918	-3.4768	-151.3701
2.96	29.3905	-3.9226	-154.5885	-0.8286	2.9105	31.7193	-4.4705	-157.197	27.0617	-3.3747	-151.9799
2.976	29.3017	-3.8078	-155.2686	-0.8657	2.8188	31.4974	-4.5421	-157.9889	27.106	-3.0735	-152.5483
2.992	29.3414	-3.7829	-156.2839	-0.8635	2.8627	31.5724	-4.4217	-158.9985	27.1103	-3.1441	-153.5694
3.008	29.9183	-4.4128	-157.0879	-0.994	2.9855	31.527	-4.6659	-159.5908	28.3096	-4.1597	-154.585
3.024	30.2362	-4.0686	-157.3305	-0.8235	2.9487	32.2445	-4.4608	-159.5388	28.2279	-3.6764	-155.1223
3.04	30.3854	-3.8879	-158.2188	-0.8743	2.99	32.5051	-4.2117	-160.7826	28.2657	-3.5641	-155.6551
3.056	30.0584	-4.2719	-159.8743	-0.8148	-3.1037	32.7229	-4.1708	-162.7025	27.3939	-4.3731	-157.046
3.072	29.9654	-4.0038	-160.4302	-0.6741	-2.9605	32.56	-3.5288	-162.5375	27.3707	-4.4788	-158.323
3.088	30.2567	-3.8718	-161.6295	-0.6484	-2.9771	33.2981	-3.3671	-163.9656	27.2153	-4.3765	-159.2935
3.104	30.5428	-3.9276	-162.4807	-0.6245	-2.8115	33.6137	-2.8755	-164.8205	27.4719	-4.9797	-160.141
3.12	30.4911	-3.7653	-163.0406	-0.5714	-2.8808	33.9663	-2.8377	-165.3533	27.0159	-4.6928	-160.7279
3.136	30.555	-3.8604	-163.9672	-0.6533	-2.6191	32.829	-2.551	-165.9756	28.281	-5.1699	-161.9588
3.152	31.1572	-3.5664	-165.2013	-0.6069	-2.8032	34.075	-2.5396	-167.3491	28.2394	-4.5933	-163.0536
3.168	30.8359	-3.1571	-165.2609	-0.6708	-2.7795	33.6957	-2.0738	-167.688	27.976	-4.2403	-162.8339
3.184	30.4318	-3.4164	-166.12	-0.6989	-2.6765	33.1619	-2.0463	-168.6869	27.7016	-4.7865	-163.553
3.2	30.8298	-3.266	-167.0721	-0.7136	-2.6017	33.2483	-1.8167	-169.5131	28.4114	-4.7153	-164.631
3.216	29.7949	-2.8325	-167.9078	-0.7302	-2.3637	31.673	-0.9825	-170.2676	27.9169	-4.6824	-165.5479
3.232	29.6248	-3.1596	-168.804	-0.7559	-2.3207	31.4322	-1.2193	-171.3039	27.8174	-5.0999	-166.3042
3.248	29.4039	-3.3221	-169.588	-0.7358	-2.2689	31.0183	-1.398	-171.8621	27.7896	-5.2462	-167.3139
3.264	29.5602	-2.6807	-170.5935	-0.7589	-2.2383	30.9737	-0.8874	-172.7591	28.1466	-4.474	-168.4279
3.28	29.37	-2.7554	-171.3019	-0.7383	-2.0597	30.4989	-0.6331	-173.4894	28.2411	-4.8777	-169.1145
3.296	29.2279	-2.258	-171.9042	-0.6922	-2.2048	30.8011	-0.1181	-174.1058	27.6546	-4.3978	-169.7025
3.312	29.3067	-2.2971	-172.7882	-0.7855	-2.0857	30.3794	-0.401	-174.9672	28.2339	-4.1931	-170.6092
3.328	28.7933	-2.2045	-173.9486	-0.757	-1.8308	29.4551	0.2834	-176.3808	28.1314	-4.6923	-171.5164
3.344	28.6013	-2.2679	-175.1159	-0.6887	-1.6954	28.9336	0.3846	-177.3166	28.269	-4.9204	-172.9151
3.36	28.3766	-2.0574	-175.9621	-0.7247	-1.618	28.5226	1.031	-178.6999	28.2306	-5.1458	-173.2243
3.376	27.471	-1.1512	-177.1985	-0.688	-1.3436	26.8077	1.7176	-179.6191	28.1343	-4.0201	-174.7779
3.392	27.726	-2.124	-178.0838	-0.7407	-1.4644	27.4015	0.9158	-180.8794	28.0506	-5.1638	-175.2882
3.408	27.3614	-1.7214	-178.8172	-0.7322	-1.3585	26.7248	1.2325	-181.5336	27.9979	-4.6754	-176.1008
3.424	26.9557	-1.9557	-179.7013	-0.7283	-1.3547	26.3094	0.9885	-182.3897	27.602	-4.8999	-177.0128
3.44	27.0572	-1.9021	-180.4961	-0.6641	-1.3608	26.3758	1.2946	-183.0542	27.7385	-5.0989	-177.9381
3.456	26.7034	-1.913	-181.7565	-0.7218	-1.2477	25.7541	0.9219	-184.3881	27.6526	-4.7478	-179.125

Man4	time	pos(x)	pos(y)	pos(z)	el	az	x1	y1	z1	x2	y2	z2
	3.472	25.9728	-1.491	-182.2998	-0.6167	-1.3233	25.1562	1.7407	-184.6632	26.7894	-4.7228	-179.9365
	3.488	26.2371	-1.9661	-183.1278	-0.5489	-0.8904	24.3599	0.3532	-184.9528	28.1142	-4.2853	-181.3029
	3.504	25.731	-1.8651	-183.8853	-0.6549	-1.0984	24.4237	0.6929	-186.0917	27.0382	-4.4232	-181.679
	3.52	25.8067	-2.5097	-184.5081	-0.6834	-0.9529	24.4026	-0.5342	-186.4815	27.2108	-4.4851	-182.5347
	3.536	25.7189	-2.8273	-185.2104	-0.5334	-1.0677	24.1365	0.0479	-187.1484	27.3013	-5.7025	-183.2725
	3.552	25.108	-2.3527	-186.3783	-0.6402	-0.9903	23.4332	0.2009	-188.6528	26.7828	-4.9063	-184.1039
	3.568	24.4121	-2.998	-187.0836	-0.6573	-0.8317	22.6295	-1.0421	-189.126	26.1947	-4.9539	-185.0411
	3.584	24.3491	-2.8895	-187.8322	-0.5505	-0.7315	22.4282	-1.1652	-189.4167	26.27	-4.6139	-186.2478
	3.6	24.8249	-3.2394	-188.923	-0.6676	-0.9528	23.3435	-1.1557	-190.9386	26.3063	-5.3231	-186.9074
	3.616	24.7265	-3.2973	-190.2161	-0.5826	-0.6881	22.5666	-1.5216	-192.0584	26.8865	-5.073	-188.3738
	3.632	24.2928	-3.6411	-191.1893	-0.564	-0.7534	21.8683	-1.3668	-193.292	26.7173	-5.9154	-189.0867
	3.648	24.3181	-4.1716	-191.5957	-0.63	-0.6777	22.2457	-2.5035	-193.5355	26.3905	-5.8398	-189.6558
	3.664	24.0063	-4.4268	-193.1389	-0.6472	-0.6416	21.6812	-2.6898	-195.3323	26.3313	-6.1638	-190.9455
	3.68	24.1008	-5.0467	-193.8107	-0.6687	-0.3926	21.8295	-4.1061	-195.7533	26.3722	-5.9873	-191.8681
	3.696	24.0505	-5.8834	-195.4984	-0.8132	-0.3391	21.8577	-5.1099	-197.9568	26.2432	-6.6569	-193.04
	3.712	24.0278	-6.0549	-195.9034	-0.8811	-0.3592	22.1721	-5.3581	-198.3067	25.8834	-6.7517	-193.5002
	3.728	23.7875	-6.4349	-197.1291	-0.7533	-0.3718	21.6195	-5.5896	-199.3112	25.9556	-7.2801	-194.9471
	3.744	23.7606	-7.0927	-197.8502	-0.8387	-0.3109	21.6641	-6.4191	-200.3007	25.857	-7.7663	-195.3998
	3.76	23.9272	-7.1592	-199.1965	-0.8109	-0.1967	21.9506	-6.7654	-201.3174	25.9039	-7.553	-197.0756
	3.776	24.1292	-7.4977	-200.2918	-0.7458	-0.236	21.9297	-6.9686	-202.3817	26.3287	-8.0267	-198.202
	3.792	23.9284	-8.1822	-200.6895	-0.8468	-0.2306	21.8287	-7.6893	-203.1289	26.0281	-8.6751	-198.25
	3.808	24.5843	-8.3845	-201.6288	-0.8928	0.0881	22.705	-8.5505	-203.9717	26.4636	-8.2185	-199.286
	3.824	24.2244	-9.362	-202.4608	-0.9179	0.0868	22.1923	-9.5388	-205.1279	26.2565	-9.1853	-199.7937
	3.84	24.3457	-9.624	-203.4874	-0.901	0.1324	22.3021	-9.8962	-206.0907	26.3894	-9.3517	-200.8841
	3.856	24.8324	-10.0823	-204.5199	-0.9382	0.1768	22.8617	-10.4344	-207.2509	26.8031	-9.7303	-201.7889
	3.872	24.8219	-10.1751	-205.6276	-1.0877	0.3204	23.5019	-10.6131	-208.2791	26.142	-9.7371	-202.9761
	3.888	24.9454	-10.8178	-205.8309	-1.0289	0.3011	23.3805	-11.3039	-208.5528	26.5104	-10.3318	-203.109
	3.904	25.2598	-11.3393	-206.66	-0.9059	0.2994	23.4464	-11.8991	-209.0808	27.0733	-10.7794	-204.2391
	3.92	25.7141	-11.558	-207.7264	-1.0696	0.658	24.6627	-12.3706	-210.1521	26.7655	-10.7454	-205.3007
	3.936	26.4394	-12.3357	-208.3894	-1.0667	0.2411	25.0955	-12.6662	-210.8982	27.7833	-12.0052	-205.8807
	3.952	26.5849	-13.0727	-209.5126	-1.031	0.67	25.2243	-14.1506	-212.4099	27.9455	-11.9947	-206.6152
	3.968	27.1368	-13.4582	-209.9481	-0.9434	0.5196	25.6734	-14.2954	-212.2732	28.6002	-12.621	-207.623
	3.984	28.4476	-13.5955	-210.7772	-1.1281	0.6425	27.3777	-14.3962	-213.5957	29.5175	-12.7948	-207.9588
	4	28.4018	-14.1315	-211.4428	-1.116	0.6347	27.2575	-14.9741	-214.3492	29.5461	-13.2888	-208.5364
	4.016	29.1574	-14.1974	-212.0388	-1.175	1.0356	28.6052	-15.1286	-214.6298	29.7095	-13.2661	-209.4479
	4.032	29.3995	-14.4313	-212.6875	-1.0805	1.3125	29.0365	-15.8052	-215.3501	29.7625	-13.0574	-210.0249
	4.048	29.6191	-14.7834	-213.2733	-1.1714	1.1808	29.1888	-15.8303	-215.9553	30.0494	-13.7365	-210.5912
	4.064	29.6621	-14.6208	-214.1235	-1.1631	1.7064	29.8243	-15.8094	-216.901	29.4999	-13.4321	-211.346
	4.08	29.8767	-15.2988	-214.5305	-1.2059	1.6651	29.9797	-16.3881	-217.3948	29.7737	-14.2095	-211.6662
	4.096	30.0129	-15.3361	-214.9101	-1.2148	1.6997	30.1387	-16.3071	-217.5433	29.8871	-14.3651	-212.2769
	4.112	30.9697	-15.2619	-215.6082	-1.0489	1.565	30.9615	-16.6746	-218.0647	30.9778	-13.8493	-213.1517
	4.128	30.9299	-16.1971	-216.0329	-1.1793	2.0993	31.4474	-17.0834	-218.5189	30.4123	-15.3108	-213.5469
	4.144	31.711	-15.9199	-216.3777	-1.2309	1.8718	31.9874	-16.8102	-219.0141	31.4345	-15.0296	-213.7412
	4.16	31.0334	-15.8008	-217.5092	-0.9671	2.0714	31.8465	-17.2869	-219.9658	30.2204	-14.3148	-215.0526
	4.176	31.6088	-16.2203	-218.3619	-1.0283	1.9654	32.192	-17.6209	-220.8787	31.0255	-14.8196	-215.8452
	4.192	32.0707	-16.4073	-219.3114	-1.026	2.3407	33.1269	-17.4968	-221.8155	31.0146	-15.3178	-216.8073
	4.208	32.25	-16.3099	-219.4799	-0.8723	2.3824	33.6846	-17.6713	-221.8351	30.8154	-14.9484	-217.1247
	4.224	32.4856	-16.5054	-220.3935	-0.9107	2.356	33.8931	-17.9134	-222.9584	31.0782	-15.0974	-217.8286
	4.24	32.1316	-16.4114	-220.9014	-1.0045	2.3792	33.263	-17.492	-223.3625	31.0002	-15.3309	-218.4404
	4.256	32.6049	-17.3948	-221.3085	-0.9235	2.9974	34.7017	-17.6993	-224.1113	30.508	-17.0903	-218.5057
	4.272	32.6085	-17.6871	-221.9325	-0.9405	-3.1133	34.7495	-17.6265	-224.8682	30.4676	-17.7476	-218.9967
	4.288	32.9607	-17.926	-223.2587	-0.9054	2.8541	34.8711	-18.4908	-225.7974	31.0503	-17.3611	-220.72
	4.304	33.2203	-18.2873	-223.499	-0.9235	2.9677	35.1379	-18.6242	-226.0748	31.3026	-17.9503	-220.9232
	4.32	33.5892	-18.004	-224.9549	-0.903	3.0147	35.6868	-18.2716	-227.6361	31.4915	-17.7365	-222.2737
	4.336	33.5759	-18.3339	-225.2398	-0.8758	2.9586	35.8307	-18.7512	-227.9903	31.321	-17.9166	-222.4893
	4.352	33.4081	-18.5937	-225.6715	-0.9319	2.8265	35.0952	-19.1436	-228.0603	31.721	-18.0437	-223.2827
	4.368	33.4189	-18.5077	-226.8728	-0.8166	2.8708	35.4102	-19.0605	-229.0725	31.4276	-17.9549	-224.673
	4.384	34.3145	-18.4607	-227.5658	-1.0557	2.7967	35.4554	-18.8705	-229.7071	33.1737	-18.051	-225.4245
	4.4	34.5218	-18.3095	-228.3778	-1.0403	2.82	35.8089	-18.7383	-230.6908	33.2347	-17.8807	-226.0649
	4.416	33.7863	-19.1235	-228.7653	-0.9725	2.5812	35.0695	-19.9288	-230.9876	32.5032	-18.3183	-226.5431
	4.432	33.9426	-19.1545	-229.4931	-0.9757	2.9701	35.5723	-19.4368	-231.9362	32.3129	-18.8722	-227.05
	4.448	34.0772	-18.9176	-230.8913	-0.9535	2.7695	35.6568	-19.5342	-233.28	32.4975	-18.301	-228.5026
	4.464	34.4402	-19.1578	-231.7981	-1.0011	2.8175	35.7674	-19.6036	-233.9837	33.113	-18.712	-229.6125
	4.48	34.5523	-18.665	-232.4504	-1.1919	2.8878	35.4492	-18.8977	-234.7775	33.6555	-18.4324	-230.1233
	4.496	34.0937	-18.9403	-232.8501	-1.2792	-2.9371	34.9019	-18.7727	-235.5999	33.2855	-19.1079	-230.1002
	4.512	34.1146	-18.6183	-234.4413	-1.1457	2.7859	35.2469	-19.0391	-237.1096	32.9822	-18.1976	-231.773

Man4											
time	pos(x)	pos(y)	pos(z)	el	az	x1	y1	z1	x2	y2	z2
4.528	34.4168	-18.6632	-234.8772	-1.1205	2.9387	35.7354	-18.9345	-237.6624	33.0981	-18.3919	-232.092
4.544	34.3455	-18.1635	-235.5387	-1.1426	2.5908	35.3369	-18.7724	-238.0874	33.3541	-17.5547	-232.9899
4.56	34.3407	-18.6595	-236.0237	-1.0552	2.8812	35.7254	-19.0284	-238.5521	32.9559	-18.2905	-233.4952
4.576	33.9716	-18.3839	-237.3007	-1.1507	3.0787	35.1528	-18.4582	-239.9503	32.7904	-18.3095	-234.6511
4.592	34.0487	-18.7188	-238.4222	-1.2702	-3.0868	34.9738	-18.668	-241.411	33.1237	-18.7695	-235.4335
4.608	33.7493	-18.0311	-239.6282	-1.1925	3.0055	34.8383	-18.1802	-242.394	32.6603	-17.882	-236.8625
4.624	33.7656	-17.9921	-240.359	-1.3904	-2.618	34.2521	-17.7112	-243.4388	33.2791	-18.273	-237.2793
4.64	33.6547	-17.8377	-241.4008	-1.2993	-3.1401	34.5083	-17.8364	-244.4667	32.8011	-17.839	-238.3349
4.656	33.3543	-17.8725	-241.7527	-1.3322	2.6778	33.9526	-18.1717	-244.5024	32.7561	-17.5732	-239.003
4.672	32.9953	-17.7595	-243.0426	-1.2887	-2.9229	33.9899	-17.5385	-246.5576	32.0007	-17.9805	-239.5275
4.688	33.6172	-17.5649	-243.8185	-1.4199	-2.7434	34.0784	-17.3709	-247.1103	33.156	-17.7589	-240.5267
4.704	33.206	-17.8019	-244.3161	-1.4266	-2.6939	33.6726	-17.5778	-247.8823	32.7393	-18.026	-240.7498
4.72	33.3845	-16.6764	-245.8701	-1.4207	-2.8972	33.9015	-16.5475	-249.3936	32.8675	-16.8053	-242.3467
4.736	32.9748	-16.7101	-246.8874	-1.3384	-2.1762	33.8465	-15.9706	-250.6866	32.463	-17.4495	-243.0882
4.752	33.0089	-16.6871	-247.6184	-1.3018	-1.8486	33.2796	-15.738	-251.1984	32.7382	-17.6362	-244.0385
4.768	32.4467	-17.1525	-248.1785	-1.52	-3.0163	32.6156	-17.1312	-251.5285	32.2778	-17.1737	-244.8285
4.784	32.2707	-16.9872	-249.3216	-1.4967	-1.0102	32.1361	-16.7729	-252.7298	32.4052	-17.2015	-245.9134
4.8	32.5955	-16.8604	-250.076	-1.4311	-1.4408	32.5318	-16.3729	-253.5727	32.6592	-17.3479	-246.5793
4.816	32.4498	-17.2941	-250.8989	-1.3595	-0.6522	31.7958	-16.7946	-254.7357	33.1039	-17.7935	-247.0621
4.832	31.6751	-17.0498	-251.6857	-1.4169	-1.0197	31.3808	-16.571	-255.3089	31.9694	-17.5286	-248.0625
4.848	31.4631	-17.0147	-252.5475	-1.3919	-1.3204	31.2949	-16.3572	-256.3001	31.6312	-17.6723	-248.7948
4.864	31.6304	-16.933	-253.4847	-1.3686	-0.8012	31.0946	-16.38	-257.2402	32.1663	-17.486	-249.7292
4.88	31.6904	-16.9224	-254.5481	-1.358	-0.8471	31.2441	-16.4173	-257.6682	32.1367	-17.4275	-251.428
4.896	31.251	-17.4	-255.2644	-1.2262	-0.7265	30.2782	-16.5356	-258.8898	32.2239	-18.2645	-251.6389
4.912	30.8054	-17.5184	-255.8428	-1.17	-1.3022	30.3344	-15.8073	-260.0313	31.2763	-19.2294	-251.6543
4.928	31.0977	-16.7086	-257.3042	-1.1088	-1.3877	30.7518	-14.8404	-261.1202	31.4435	-18.5767	-253.4882
4.944	31.2822	-16.3255	-257.8838	-1.1066	-1.354	30.8633	-14.4239	-261.7728	31.7011	-18.2271	-253.9948
4.96	30.8994	-16.5826	-258.8434	-1.1319	-1.1591	30.2017	-14.9846	-262.558	31.5972	-18.1805	-255.1288
4.976	31.1185	-16.9274	-259.5354	-1.1394	-1.2023	30.481	-15.2764	-263.3804	31.756	-18.5783	-255.6904
4.992	31.0232	-16.5177	-260.5231	-1.0877	-1.3174	30.5431	-14.6642	-264.1732	31.5032	-18.3713	-256.873
5.008	30.4492	-16.5361	-261.5366	-1.1151	-0.9706	29.5487	-15.2203	-264.7898	31.3496	-17.8518	-258.2833
5.024	30.1706	-17.2485	-262.0837	-1.0884	-0.9096	29.0807	-15.8478	-265.4728	31.2604	-18.6493	-258.6947
5.04	30.0996	-17.4758	-262.8402	-1.0943	-0.7662	28.9474	-16.3669	-265.9386	31.2518	-18.5847	-259.7419
5.056	30.3311	-16.8798	-264.2698	-1.0229	-0.7421	28.8512	-15.5228	-267.5605	31.811	-18.2368	-260.9791
5.072	30.174	-17.0358	-264.6339	-0.9778	-0.6894	28.3654	-15.545	-268.1116	31.9826	-18.5266	-261.1563
5.088	29.9832	-16.9074	-265.8374	-1.0569	-0.7705	28.5328	-15.4996	-269.4184	31.4337	-18.3152	-262.2564
5.104	29.7349	-16.859	-266.6155	-1.035	-0.8359	28.2582	-15.2249	-270.3255	31.2117	-18.4931	-262.9056
5.12	29.705	-17.0606	-267.0302	-1.0498	-0.8641	28.3618	-15.4876	-270.6347	31.0481	-18.6337	-263.4257
5.136	30.1845	-17.3587	-268.0598	-1.0572	-1.0751	29.2262	-15.5862	-271.6321	31.1429	-19.1311	-264.4875
5.152	29.9013	-17.3163	-268.9298	-1.0681	-0.7172	28.4607	-16.0598	-272.4067	31.3418	-18.5727	-265.453
5.168	29.692	-17.4581	-270.1145	-1.22	-1.1691	29.184	-16.2621	-273.6653	30.2001	-18.654	-266.5636
5.184	30.3064	-17.7482	-270.5233	-1.2024	-0.7611	29.4531	-16.9354	-273.5763	31.1597	-18.561	-267.4703
5.2	30.206	-18.2279	-271.6067	-1.217	-0.5393	29.1918	-17.6208	-274.8071	31.2203	-18.8349	-268.4063
5.216	29.8244	-18.1457	-272.1783	-1.2044	-0.5629	28.9006	-17.5627	-275.0249	30.7483	-18.7287	-269.3317
5.232	29.4976	-18.1216	-273.0355	-1.2586	-0.5727	28.6737	-17.5904	-276.0725	30.3215	-18.6528	-269.9985
5.248	29.941	-18.4213	-273.588	-1.2292	-0.6762	29.1085	-17.7534	-276.5903	30.7734	-19.0892	-270.5857
5.264	29.8199	-18.6937	-274.3308	-1.2642	-0.5835	29.0501	-18.1855	-277.2442	30.5897	-19.202	-271.4173
5.28	29.3815	-18.9013	-275.2467	-1.2265	-0.1016	28.4027	-18.8016	-277.9901	30.3603	-19.0011	-272.5033
5.296	29.5351	-19.3778	-275.6944	-1.1278	-0.111	28.2744	-19.2373	-278.3679	30.7959	-19.5182	-273.021
5.312	29.0956	-19.4781	-276.2143	-1.1342	0.0127	28.0186	-19.4917	-278.5225	30.1727	-19.4644	-273.9062
5.328	29.0131	-19.1846	-277.5241	-1.1223	0.3129	27.9708	-19.5219	-279.8004	30.0553	-18.8474	-275.2477
5.344	29.0712	-19.608	-277.8119	-1.2439	-0.1751	28.0848	-19.4335	-280.7658	30.0575	-19.7824	-274.8581

Manta											
time	pos(x)	pos(y)	pos(z)	el	az	x1	y1	z1	x2	y2	z2
0	0	0	0	-0.7165	-1.8868	0.2273	0.6953	-0.6371	-0.2273	-0.6953	0.6371
0.016	-0.748	1.1373	-3.1868	0.2542	-1.856	-0.3519	2.4886	-2.821	-1.1442	-0.2139	-3.5526
0.032	-0.5424	-0.1067	-9.9725	-0.5003	-1.7608	-0.3707	0.7862	-10.4696	-0.7141	-0.9996	-9.4754
0.048	-1.0062	0.1588	-14.9747	-1.2983	-1.9182	-0.8714	0.531	-16.3917	-1.141	-0.2135	-13.5576
0.064	-0.6907	-0.2062	-20.2648	-1.3224	-2.0538	-0.5257	0.1086	-21.6666	-0.8558	-0.521	-18.8631
0.08	-0.6085	-0.0342	-25.3783	-1.1793	2.3993	-0.2535	-0.3598	-26.5455	-0.9635	0.2915	-24.2111
0.096	-0.1589	-0.3256	-29.6856	-1.1973	-2.3535	0.0811	-0.0842	-30.5543	-0.399	-0.5669	-28.8169
0.112	-0.4386	-0.9452	-34.8807	-1.0897	-2.9573	0.0192	-0.8599	-35.7727	-0.8964	-1.0305	-33.9886
0.128	-0.7294	-1.849	-39.2502	-1.0669	2.6172	-0.3806	-2.0507	-39.9809	-1.0781	-1.6472	-38.5195
0.144	-0.1735	-2.7783	-42.744	-1.1728	1.7718	-0.111	-3.085	-43.4884	-0.236	-2.4716	-41.9996

Man5	time	pos(x)	pos(y)	pos(z)	el	az	x1	y1	z1	x2	y2	z2
	0.16	-0.9058	-3.4318	-46.04	-0.6419	1.9715	-0.5535	-4.2634	-46.7151	-1.2581	-2.6001	-45.3648
	0.176	-1.1763	-3.4294	-46.9963	-0.8126	1.3291	-1.5887	-5.1022	-48.8157	-0.764	-1.7566	-45.1768
	0.192	-2.4943	-3.5386	-48.6576	-1.0625	0.3252	-3.9207	-4.0196	-51.3597	-1.0678	-3.0576	-45.9555
	0.208	-2.2306	-6.65	-53.6021	-0.6655	-0.3942	-3.9332	-5.9418	-55.0496	-0.528	-7.3583	-52.1547
	0.224	-2.7011	-6.8992	-56.1059	-1.1399	-1.7233	-2.5883	-6.1657	-57.7203	-2.8138	-7.6327	-54.4916
	0.24	-1.0971	-7.7219	-57.5529	-0.5293	-2.7408	0.7956	-6.92	-58.7554	-2.9898	-8.5238	-56.3504
	0.256	-1.9616	-8.5352	-58.433	-1.0549	-2.4081	-1.3274	-7.9636	-59.9386	-2.5959	-9.1068	-56.9274
	0.272	-2.5202	-8.7068	-59.2317	-0.9745	-2.205	-1.8695	-7.8221	-60.8499	-3.1709	-9.5914	-57.6136
	0.288	-2.7586	-9.09	-59.3896	-0.6043	-1.925	-2.3445	-7.9703	-60.2139	-3.1726	-10.2096	-58.5654
	0.304	-3.1936	-9.7628	-60.9263	-1.035	-1.9104	-2.9673	-9.1222	-62.0707	-3.4198	-10.4035	-59.7819
	0.32	-3.4064	-9.8224	-61.5457	-0.9822	-1.3392	-3.5809	-9.0821	-62.6851	-3.2318	-10.5627	-60.4063
	0.336	-3.9919	-11.7345	-64.8246	-0.6332	-1.382	-4.1655	-10.826	-65.5035	-3.8183	-12.6429	-64.1457
	0.352	-4.5275	-11.65	-64.7843	-0.7959	-0.8452	-5.1007	-11.0037	-65.6665	-3.9543	-12.2962	-63.9022
	0.368	-4.9826	-13.5909	-66.9978	-1.0049	-1.3263	-5.1966	-12.7333	-68.3895	-4.7686	-14.4485	-65.6062
	0.384	-5.5652	-14.5969	-68.2231	-1.2152	-1.5938	-5.5504	-13.9523	-69.9594	-5.58	-15.2415	-66.4869
	0.4	-5.7842	-13.392	-67.2644	-1.4947	1.036	-5.8774	-13.5493	-69.6637	-5.691	-13.2347	-64.8651
	0.416	-6.0219	-13.6389	-67.9352	-1.5036	1.4261	-6.052	-13.8455	-71.0396	-5.9918	-13.4323	-64.8308
	0.432	-6.0906	-13.3891	-67.9264	-1.5071	0.8332	-6.1905	-13.499	-70.255	-5.9907	-13.2791	-65.5979
	0.448	-6.2227	-13.7631	-68.4593	-1.447	0.8914	-6.4227	-14.0107	-71.0185	-6.0227	-13.5154	-65.9
	0.464	-6.2033	-14.7037	-69.7076	-1.3826	1.5313	-6.2258	-15.2757	-72.7137	-6.1807	-14.1318	-66.7016
	0.48	-6.3111	-14.9037	-70.3707	-1.3583	1.75	-6.192	-15.5615	-73.4695	-6.4303	-14.2459	-67.2719
	0.496	-6.7593	-15.4518	-70.9384	-1.3292	1.1541	-7.0516	-16.1121	-73.8687	-6.467	-14.7915	-68.0081
	0.512	-6.9941	-15.279	-71.2444	-1.2684	1.5335	-7.0281	-16.1911	-74.1699	-6.9601	-16.3669	-68.3188
	0.528	-6.7213	-16.074	-72.2197	-1.3174	1.3164	-6.9181	-16.8306	-75.2392	-6.5246	-15.3174	-69.2002
	0.544	-7.4006	-15.9505	-72.4721	-1.0994	1.6294	-7.3206	-17.3142	-75.1523	-7.4805	-14.5868	-69.7919
	0.56	-7.1719	-16.4966	-73.8784	-1.0239	1.528	-7.2386	-18.0547	-76.4401	-7.1052	-14.9385	-71.3166
	0.576	-7.3786	-16.7545	-74.6745	-1.0078	1.388	-7.6188	-18.0538	-76.7683	-7.1384	-15.4552	-72.5807
	0.592	-7.0563	-16.8221	-74.8142	-1.0206	1.575	-7.0497	-18.398	-77.3832	-7.063	-15.2462	-72.2453
	0.608	-7.5539	-17.36	-75.5292	-1.0901	1.2993	-7.8845	-18.5475	-77.8931	-7.2233	-16.1724	-73.1654
	0.624	-7.7667	-17.5942	-76.3859	-0.9164	1.5205	-7.87	-19.6478	-79.0662	-7.6634	-15.5406	-73.7056
	0.64	-7.6003	-18.4612	-78.3002	-0.9683	1.5418	-7.6517	-20.2321	-80.8756	-7.5489	-16.6904	-75.7247
	0.656	-7.6777	-18.7926	-79.0071	-0.9566	1.3684	-7.9496	-20.1181	-80.9258	-7.4057	-17.4672	-77.0883
	0.672	-7.7713	-18.9197	-79.235	-0.9409	1.3097	-8.0866	-20.0996	-80.9106	-7.456	-17.7397	-77.5595
	0.688	-7.5398	-18.838	-79.7698	-1.0839	1.5354	-7.5731	-19.7797	-81.5496	-7.5064	-17.8963	-77.9901
	0.704	-7.6759	-17.9993	-81.2	-0.9487	1.4639	-7.8637	-19.7496	-83.655	-7.488	-16.249	-78.7449
	0.72	-7.5981	-18.0976	-82.0425	-0.9321	1.5875	-7.57	-19.7787	-84.3068	-7.6262	-16.4165	-79.7782
	0.736	-7.3854	-18.9902	-83.6301	-0.9773	1.5775	-7.3762	-20.367	-85.6708	-7.3947	-17.6134	-81.5894
	0.752	-6.8439	-19.4345	-84.6224	-0.9618	1.2042	-7.2712	-20.5475	-86.3319	-6.4167	-18.3215	-82.9129
	0.768	-6.9783	-19.326	-85.8963	-0.9154	1.2884	-7.368	-20.6693	-87.7155	-6.5885	-17.9828	-84.077
	0.784	-6.5827	-19.0633	-86.4132	-1.0047	1.5304	-6.6358	-20.3794	-88.486	-6.5295	-17.7473	-84.3404
	0.8	-7.0089	-19.0138	-87.0783	-0.8884	1.1867	-7.5278	-20.2978	-88.7824	-6.4899	-17.7299	-85.3742
	0.816	-7.0683	-19.1256	-87.3108	-0.9776	1.8606	-6.6643	-20.4801	-89.4076	-7.4722	-17.771	-85.2141
	0.832	-7.0595	-19.5669	-88.6802	-0.9546	1.7787	-6.7064	-21.2407	-91.0959	-7.4126	-17.8931	-86.2645
	0.848	-6.8053	-19.474	-89.7345	-0.9882	1.8323	-6.4904	-20.6507	-91.5834	-7.1202	-18.2973	-87.8856
	0.864	-6.5553	-19.6492	-90.638	-1.0442	1.852	-6.194	-20.8998	-92.8771	-6.9165	-18.3987	-88.399
	0.88	-6.6488	-19.3866	-91.5525	-0.9876	1.8753	-6.2045	-20.8006	-93.7993	-7.0932	-17.9725	-89.3057
	0.896	-6.4707	-19.6888	-92.2778	-1.0296	1.7928	-6.1885	-20.939	-94.4102	-6.7529	-18.4385	-90.1454
	0.912	-6.4113	-19.3563	-92.6508	-1.0522	1.7687	-6.1861	-20.4795	-94.658	-6.6366	-18.233	-90.6436
	0.928	-6.2606	-19.2643	-93.3155	-1.2234	1.808	-6.0754	-20.0305	-95.4925	-6.4458	-18.4982	-91.1385
	0.944	-5.9179	-19.3914	-94.8706	-1.1129	1.8074	-5.6501	-20.5019	-97.1882	-6.1857	-18.281	-92.553
	0.96	-6.3893	-19.2031	-95.5226	-1.1976	2.2276	-5.8291	-19.9297	-97.8662	-6.9496	-18.4765	-93.1791
	0.976	-6.2278	-19.1578	-96.7208	-1.1809	2.1147	-5.6459	-20.1199	-99.4566	-6.8096	-18.1957	-93.985
	0.992	-5.7995	-18.4705	-97.2564	-1.2298	2.2283	-5.2142	-19.2286	-99.9557	-6.3848	-17.7124	-94.5571
	1.008	-5.8375	-18.4563	-98.0274	-1.2253	2.3726	-5.1505	-19.121	-100.6834	-6.5244	-17.7917	-95.3715
	1.024	-5.5119	-18.5603	-98.8691	-1.1984	2.5076	-4.6164	-19.2188	-101.7146	-6.4074	-17.9019	-96.0237
	1.04	-5.1538	-18.0571	-99.4927	-1.2049	2.3331	-4.428	-18.8172	-102.2358	-5.8797	-17.2969	-96.7496
	1.056	-5.395	-17.4703	-99.9538	-1.234	2.7183	-4.6592	-17.8018	-102.2586	-6.1308	-17.1388	-97.6489
	1.072	-5.1392	-16.9213	-100.6008	-1.2462	2.1641	-4.621	-17.6898	-103.3549	-5.6574	-16.1528	-97.8467
	1.088	-5.1139	-16.666	-101.401	-1.1878	2.5296	-4.2611	-17.2645	-103.9869	-5.9667	-16.0674	-98.815
	1.104	-5.1081	-16.9918	-102.1332	-1.3044	3.0255	-4.3544	-17.0797	-104.9136	-5.8617	-16.9039	-99.3528
	1.12	-5.2591	-16.8659	-102.6242	-1.2266	-3.0009	-4.5336	-16.7631	-104.6687	-5.9847	-16.9686	-100.5796
	1.136	-4.8024	-16.6297	-102.9252	-1.2906	-2.885	-4.2612	-16.4877	-104.8699	-5.3436	-16.7717	-100.9806
	1.152	-5.5656	-15.9401	-103.4254	-1.1475	-2.9287	-4.5866	-15.7284	-105.6487	-6.5447	-16.1517	-101.2022
	1.168	-4.6288	-15.8559	-103.8391	-1.3241	3.1195	-4.0502	-15.8687	-106.1379	-5.2075	-15.8431	-101.5403
	1.184	-4.9549	-15.3297	-103.999	-1.0944	-2.7063	-4.1799	-14.9693	-105.6553	-5.73	-15.6902	-102.3426
	1.2	-5.3047	-14.6012	-104.1741	-1.1069	-2.889	-4.3717	-14.3604	-106.1004	-6.2378	-14.8421	-102.2479

Man5	time	pos(x)	pos(y)	pos(z)	el	az	x1	y1	z1	x2	y2	z2
	1.216	-4.2434	-14.1075	-104.7296	-1.2656	-2.9413	-3.6364	-13.9843	-106.6958	-4.8505	-14.2307	-102.7634
	1.232	-4.2141	-13.4511	-105.2873	-1.106	-2.674	-3.1525	-12.915	-107.6594	-5.2758	-13.9872	-102.9152
	1.248	-4.6437	-13.3366	-106.3452	-1.0848	-1.9347	-4.3016	-12.4384	-108.1644	-4.9857	-14.2347	-104.5261
	1.264	-4.5459	-13.0046	-106.6619	-1.1529	-2.1987	-4.0456	-12.3155	-108.5795	-5.0461	-13.6937	-104.7443
	1.28	-4.6117	-12.4283	-107.0806	-1.0482	-2.3556	-3.8904	-11.7061	-108.8528	-5.3331	-13.1505	-105.3084
	1.296	-4.9998	-11.9091	-107.3897	-1.124	-2.0824	-4.6049	-11.2058	-109.0734	-5.3947	-12.6124	-105.706
	1.312	-5.0813	-11.4883	-107.8912	-1.0597	-2.2215	-4.4955	-10.7188	-109.6156	-5.6671	-12.2577	-106.1668
	1.328	-5.5195	-10.8361	-108.1884	-0.8655	-1.9667	-5.0565	-9.7284	-109.5987	-5.9825	-11.9438	-106.7782
	1.344	-5.5933	-10.2227	-108.6231	-1.1054	-1.9604	-5.1957	-9.2543	-110.7075	-5.9909	-11.1912	-106.5386
	1.36	-5.1066	-10.4466	-109.6078	-1.0444	-1.828	-4.8646	-9.5264	-111.2451	-5.3486	-11.3667	-107.9705
	1.376	-5.2752	-9.9247	-109.6902	-1.1044	-1.7529	-5.102	-8.9844	-111.5894	-5.4484	-10.865	-107.7911
	1.392	-5.3956	-9.2836	-109.8497	-0.954	-1.9074	-5.0048	-8.1668	-111.5185	-5.7865	-10.4004	-108.1809
	1.408	-5.4847	-9.1166	-110.7196	-0.8952	-1.8737	-5.0692	-7.7871	-112.4577	-5.9002	-10.446	-108.9814
	1.424	-5.4329	-9.1353	-111.2974	-0.9563	-2.0231	-4.9136	-8.0665	-112.9813	-5.9523	-10.204	-109.6134
	1.44	-5.659	-8.6438	-111.6743	-1.0767	-2.0864	-5.1265	-7.7042	-113.6792	-6.1916	-9.5835	-109.6694
	1.456	-5.8511	-8.6495	-112.6471	-0.9287	-1.8709	-5.4589	-7.3819	-114.4216	-6.2434	-9.9171	-110.8725
	1.472	-5.5212	-8.7785	-113.0464	-0.899	-1.7543	-5.2779	-7.4674	-114.7232	-5.7645	-10.0896	-111.3696
	1.488	-5.5638	-8.1348	-113.9137	-0.924	-1.643	-5.4746	-6.9022	-115.5502	-5.6531	-9.3675	-112.2772
	1.504	-5.5564	-7.7614	-114.0828	-1.0114	-2.0004	-5.0668	-6.6926	-115.9603	-6.046	-8.8302	-112.2054
	1.52	-5.619	-7.5248	-114.6124	-1.0864	-1.892	-5.2398	-6.3852	-116.8947	-5.9982	-8.6644	-112.3302
	1.536	-4.7202	-8.1439	-115.7916	-1.0387	-1.4536	-4.8396	-7.1297	-117.5262	-4.6009	-9.1581	-114.057
	1.552	-5.1774	-7.7326	-116.4734	-0.975	-1.6755	-5.0561	-6.5781	-118.1855	-5.2987	-8.887	-114.7614
	1.568	-5.2307	-7.6639	-117.2085	-0.9639	-1.8715	-4.7894	-6.241	-119.3541	-5.672	-9.0869	-115.0628
	1.584	-4.8137	-7.9256	-118.4189	-1.0116	-1.7805	-4.5647	-6.7555	-120.3302	-5.0628	-9.0956	-116.5075
	1.6	-4.9292	-7.8985	-119.1256	-0.8727	-1.6362	-4.8259	-6.3228	-121.0077	-5.0324	-9.4742	-117.2436
	1.616	-4.7733	-7.5945	-119.7586	-1.0396	-1.7224	-4.6009	-6.4663	-121.7012	-4.9457	-8.7228	-117.816
	1.632	-4.7157	-7.7417	-120.7842	-0.9281	-1.4024	-4.9461	-6.3862	-122.6206	-4.4852	-9.0972	-118.9478
	1.648	-4.5282	-7.5573	-121.1036	-0.9139	-1.5899	-4.4988	-6.0129	-123.1067	-4.5577	-9.1017	-119.1005
	1.664	-4.4362	-7.298	-122.2289	-0.9898	-1.7443	-4.2106	-6.011	-124.2188	-4.6618	-8.585	-120.2389
	1.68	-4.4059	-7.4751	-122.9075	-1.0457	-1.523	-4.4647	-6.2482	-125.0276	-4.3472	-8.702	-120.7875
	1.696	-4.5312	-7.3618	-123.2724	-1.0662	-1.5968	-4.5014	-6.2184	-125.3432	-4.5609	-8.5052	-121.2016
	1.712	-4.2449	-8.1119	-124.6465	-1.0071	-1.4605	-4.3733	-6.953	-126.4911	-4.1165	-9.2708	-122.802
	1.728	-4.1474	-8.1013	-126.0833	-1.0125	-1.5243	-4.2023	-6.9224	-127.9729	-4.0925	-9.2801	-124.1936
	1.744	-3.5422	-8.486	-126.6081	-0.9899	-1.8195	-3.2233	-7.2303	-128.5815	-3.8611	-9.7416	-124.6347
	1.76	-3.3841	-8.8598	-127.8408	-1.1827	-1.5552	-3.3969	-8.0404	-129.8451	-3.3713	-9.6792	-125.8365
	1.776	-3.441	-9.1405	-129.0167	-0.8935	-1.463	-3.612	-7.5603	-130.993	-3.27	-10.7208	-127.0404
	1.792	-3.0259	-9.1502	-129.2514	-1.0384	-1.5053	-3.1098	-7.8706	-131.4281	-2.942	-10.4299	-127.0747
	1.808	-3.007	-9.2679	-130.4901	-1.1202	-1.8183	-2.7377	-8.2023	-132.7617	-3.2762	-10.3335	-128.2186
	1.824	-2.1792	-8.8251	-130.8306	-1.1344	-1.3103	-2.4154	-7.9391	-132.7967	-1.943	-9.7112	-128.8645
	1.84	-2.1973	-9.6966	-131.5133	-1.1378	-1.5944	-2.1732	-8.6751	-133.7236	-2.2215	-10.7182	-129.303
	1.856	-1.8288	-9.7951	-133.3485	-1.1396	-1.7253	-1.6762	-8.8151	-135.5046	-1.9815	-10.7752	-131.1925
	1.872	-1.252	-10.3262	-134.1766	-1.187	-1.825	-1.0145	-9.4122	-136.5152	-1.4895	-11.2402	-131.8379
	1.888	-1.4357	-10.6107	-135.0107	-1.2403	-1.9897	-1.1076	-9.8738	-137.3617	-1.7638	-11.3475	-132.6596
	1.904	-1.4324	-11.6123	-136.0703	-1.1268	-1.487	-1.5187	-10.5853	-138.2372	-1.346	-12.6393	-133.9034
	1.92	-0.7503	-11.2768	-136.8746	-1.4168	-2.279	-0.5288	-11.0182	-139.0691	-0.9718	-11.5355	-134.6802
	1.936	-0.2346	-11.9978	-137.7915	-1.2797	2.2325	0.2028	-12.5595	-140.1675	-0.6721	-11.4361	-135.4154
	1.952	0.7431	-12.9184	-138.4748	-1.464	1.2755	0.676	-13.1389	-140.6264	0.8102	-12.6978	-136.3231
	1.968	0.2329	-12.9634	-139.0784	-1.3728	2.8439	0.224	-13.1036	-141.461	-0.6899	-12.8232	-136.6958
	1.984	0.7392	-13.087	-139.8024	-1.4352	2.4977	1.0003	-13.2829	-142.1944	0.4781	-12.891	-137.4104
	2	0.6683	-13.8173	-140.841	-1.3932	3.122	1.0435	-13.8247	-142.9317	0.2932	-13.81	-138.7504
	2.016	1.5142	-14.3778	-142.0129	-1.4516	2.3087	1.6832	-14.5637	-144.1122	1.3451	-14.1919	-139.9137
	2.032	2.2088	-14.9549	-142.5225	-1.2898	1.952	2.4665	-15.598	-144.9233	1.9511	-14.3117	-140.1217
	2.048	2.4696	-15.3536	-143.0791	-1.3887	1.6519	2.5048	-15.787	-145.4407	2.4343	-14.9202	-140.7174
	2.064	2.5453	-15.8147	-143.2807	-1.3341	2.0463	2.7898	-16.2896	-145.4956	2.3007	-15.3398	-141.0658
	2.08	2.7475	-15.8414	-144.9432	-1.0345	1.8712	3.1778	-17.2306	-147.3898	2.3172	-14.4522	-142.4966
	2.096	2.7116	-16.4203	-146.2266	-1.0771	2.1512	3.5099	-17.6377	-148.9318	1.9134	-15.203	-143.5214
	2.112	3.1031	-16.9062	-146.3921	-1.1182	1.9066	3.527	-18.1211	-149.038	2.6791	-15.6913	-143.7462
	2.128	3.8229	-17.5387	-147.2594	-1.0394	1.7871	4.1617	-19.0801	-149.9444	3.4841	-15.9974	-144.5745
	2.144	3.6344	-18.2366	-147.9188	-1.0848	1.7694	3.9365	-19.7375	-150.8166	3.3323	-16.7358	-145.021
	2.16	4.0666	-18.1462	-148.5275	-1.0609	1.846	4.4782	-19.6037	-151.2361	3.655	-16.6886	-145.8189
	2.176	3.9926	-18.4719	-149.2647	-1.1258	2.0638	4.6194	-19.6387	-152.0418	3.3657	-17.3052	-146.4876
	2.192	4.9265	-19.0478	-150.0634	-1.0822	1.8385	5.3057	-20.4305	-152.7605	4.5473	-17.665	-147.3662
	2.208	5.3331	-19.7449	-151.1564	-1.1328	2.0405	5.9151	-20.8915	-153.9018	4.751	-18.5983	-148.4109
	2.224	5.5262	-19.9355	-151.3888	-1.0724	2.0012	6.1799	-21.3593	-154.2679	4.8724	-18.5117	-148.5097
	2.24	5.6106	-20.7914	-152.2879	-0.9828	1.8225	6.057	-22.5273	-154.9765	5.1643	-19.0555	-149.5993
	2.256	5.8535	-21.3835	-152.9131	-1.0198	1.961	6.4802	-22.9071	-155.594	5.2268	-19.8599	-150.2322

Man5	time	pos(x)	pos(y)	pos(z)	el	az	x1	y1	z1	x2	y2	z2
	2.272	5.842	-21.2765	-153.1028	-1.004	2.0744	6.7389	-22.9045	-156.0235	4.945	-19.6486	-150.1821
	2.288	6.2573	-21.888	-154.0389	-1.0138	1.7753	6.6185	-23.6296	-156.8947	5.8961	-20.1465	-151.183
	2.304	6.8703	-21.1663	-154.0954	-1.1273	1.9081	7.2763	-22.3242	-156.6781	6.4643	-20.0084	-151.5127
	2.32	6.9684	-21.7735	-155.4749	-1.0875	2.0645	7.7041	-23.1406	-158.433	6.2327	-20.4063	-152.5167
	2.336	6.9453	-22.0791	-156.1032	-0.9855	2.2087	7.9525	-23.4378	-158.6549	5.9382	-20.7203	-153.5515
	2.352	7.0258	-22.2877	-157.0585	-0.9688	2.084	7.9718	-23.9665	-159.8632	6.0797	-20.609	-154.2539
	2.368	7.6393	-22.6259	-158.0215	-0.9491	1.9766	8.3773	-24.3435	-160.6305	6.9012	-20.9083	-155.4125
	2.384	7.5059	-22.8284	-158.6669	-0.9315	2.0919	8.5084	-24.575	-161.3756	6.5034	-21.0819	-155.9581
	2.4	8.0596	-22.5184	-159.5544	-0.887	1.8037	8.5197	-24.4581	-162.0006	7.5995	-20.5786	-157.1082
	2.416	7.6617	-22.9293	-160.0587	-0.9131	1.947	8.2666	-24.4605	-162.1902	7.0569	-21.3981	-157.9272
	2.432	7.6707	-22.6631	-160.7879	-0.8577	2.0899	8.7959	-24.6324	-163.4102	6.5455	-20.6937	-158.1656
	2.448	7.5959	-23.0156	-161.6769	-0.7845	2.1102	8.6651	-24.8018	-163.7551	6.5266	-21.2294	-159.5988
	2.464	7.9528	-22.2111	-162.4171	-0.8275	2.1865	9.3556	-24.1943	-165.06	6.5499	-20.228	-159.7742
	2.48	7.8955	-22.5667	-163.4722	-0.7876	1.9862	8.8291	-24.6832	-165.7959	6.9619	-20.4503	-161.1486
	2.496	8.2369	-22.8009	-164.4841	-0.8045	2.0729	9.0975	-24.3685	-166.3421	7.3762	-21.2334	-162.626
	2.512	8.2486	-22.4047	-165.2444	-0.7322	1.98	9.2358	-24.6811	-167.4749	7.2614	-20.1284	-163.0139
	2.528	8.0056	-21.5666	-166.456	-0.7161	2.1392	9.16	-23.3739	-168.3221	6.8512	-19.7593	-164.59
	2.544	7.9445	-21.9089	-167.2376	-0.7599	2.142	9.1599	-23.8	-169.374	6.7291	-20.0178	-165.1013
	2.56	8.1634	-21.8948	-167.8952	-0.8728	2.1346	9.1759	-23.4962	-170.1538	7.1509	-20.2934	-165.6365
	2.576	8.5966	-21.603	-168.8154	-0.8974	1.9337	9.1883	-23.1617	-170.9051	8.0048	-20.0443	-166.7257
	2.592	7.6502	-21.7234	-169.749	-1.0793	2.1185	8.2758	-22.7492	-171.9937	7.0245	-20.6976	-167.5043
	2.608	8.4228	-20.8603	-170.5599	-1.0554	2.2868	9.1078	-21.6476	-172.4019	7.7379	-20.073	-168.7179
	2.624	8.4779	-21.3221	-171.4149	-0.963	2.4328	9.6393	-22.318	-173.6142	7.3165	-20.3262	-169.2156
	2.64	7.831	-20.9351	-172.4722	-1.0252	2.8641	9.1455	-21.3095	-174.7235	6.5165	-20.5608	-170.221
	2.656	8.02	-19.1643	-172.5816	-0.7135	2.2446	9.702	-21.2708	-174.9152	6.3379	-17.0578	-170.248
	2.672	7.9255	-19.7405	-174.1773	-0.9241	-3.0214	9.6271	-19.5349	-176.4473	6.224	-19.946	-171.9073
	2.688	7.7252	-19.4766	-175.1725	-0.8911	-2.9605	9.4975	-19.152	-177.4022	5.9529	-19.8012	-172.9429
	2.704	7.519	-19.1867	-175.9429	-0.9213	-2.8808	9.2226	-18.732	-178.2647	5.8154	-19.6414	-173.621
	2.72	7.5285	-19.4101	-177.0501	-0.874	-2.8059	9.2336	-18.8152	-179.2081	5.8235	-20.0049	-174.8921
	2.736	7.3228	-19.4933	-177.4297	-0.9317	-2.6851	8.8112	-18.7624	-179.6611	5.8344	-20.2242	-175.1983
	2.752	7.6108	-18.222	-178.6757	-0.8803	-2.4268	8.8398	-17.1553	-180.6455	6.3818	-19.2887	-176.7058
	2.768	7.6824	-17.7914	-179.3096	-0.9512	-2.4114	8.8407	-16.7544	-181.4889	6.5241	-18.8283	-177.1303
	2.784	5.5097	-17.6686	-180.7154	-0.8024	-2.3514	6.9304	-16.2343	-182.8039	4.089	-19.103	-178.6269
	2.8	5.4802	-16.6242	-181.3197	-0.8751	-2.7067	7.3683	-15.747	-183.813	3.592	-17.5013	-178.8265
	2.816	5.2338	-15.8457	-181.7952	-0.9416	-2.5067	6.7609	-14.7208	-184.401	3.7066	-16.9706	-179.1895
	2.832	4.7055	-15.4927	-182.7159	-0.853	-2.3647	6.1459	-14.0766	-185.0293	3.2652	-16.9089	-180.4025
	2.848	4.2447	-15.3089	-183.7716	-0.903	-2.4016	5.6863	-13.9927	-186.2467	2.8031	-16.6251	-181.2964
	2.864	3.7874	-14.9693	-184.7817	-0.8611	-2.3589	5.3646	-13.4008	-187.3714	2.2103	-16.5378	-182.192
	2.88	3.4391	-14.2682	-185.3533	-0.8707	-2.2709	4.7253	-12.7414	-187.7229	2.1529	-15.795	-182.9836
	2.896	2.8365	-14.246	-185.858	-0.8324	-2.3631	4.4143	-12.6899	-188.293	1.2587	-15.802	-183.4231
	2.912	2.5891	-14.1105	-186.5882	-0.8036	-1.987	3.4547	-12.1521	-188.8086	1.7235	-16.0688	-184.3677
	2.928	1.6488	-13.7453	-187.5789	-0.8053	-2.0064	2.6346	-11.6271	-190.01	0.663	-15.8635	-185.1478
	2.944	1.2837	-14.0306	-187.8805	-0.7322	-1.8701	2.008	-11.6836	-190.0884	0.5593	-16.3776	-185.6726
	2.96	1.3321	-12.8745	-189.2331	-0.8734	-1.8838	1.9534	-10.9552	-191.6407	0.7109	-14.7938	-186.8255
	2.976	0.9293	-12.627	-189.7332	-0.7828	-1.8566	1.5941	-10.3648	-192.079	0.2646	-14.8892	-187.3874
	2.992	0.3596	-13.3032	-190.0941	-0.8597	-1.9254	1.036	-11.4765	-192.3553	-0.3168	-15.13	-187.8328
	3.008	-0.4629	-12.7847	-190.7159	-0.824	-1.8499	0.1643	-10.5956	-193.1762	-1.0902	-14.9738	-188.2557
	3.024	-0.5914	-12.4129	-191.4712	-1.0212	-1.8749	-0.1229	-10.9201	-194.0254	-1.0599	-13.9057	-188.917
	3.04	-2.0981	-12.2853	-192.2783	-1.0097	-1.8018	-1.7405	-10.7647	-194.7639	-2.4558	-13.8059	-189.7927
	3.056	-1.3148	-12.9698	-192.7931	-0.9177	-1.7821	-0.9122	-11.0927	-195.3023	-1.7175	-14.847	-190.2838
	3.072	-1.6689	-12.703	-193.9136	-0.9398	-1.7141	-1.4163	-10.9524	-196.3343	-1.9215	-14.4535	-191.4929
	3.088	-2.5588	-12.4276	-194.3642	-1.0694	-1.8166	-2.2002	-10.998	-197.0529	-2.9174	-13.8572	-191.6754
	3.104	-2.9099	-11.6069	-195.4204	-1.0806	-1.8651	-2.4754	-10.1734	-198.227	-3.3445	-13.0403	-192.6139
	3.12	-2.5552	-12.5752	-195.9814	-1.0812	-1.6978	-2.3655	-11.0898	-198.7914	-2.7449	-14.0605	-193.1713
	3.136	-3.7904	-11.7034	-196.7106	-0.8969	-1.3242	-4.3578	-9.4492	-199.6215	-3.223	-13.9576	-193.7997
	3.152	-4.724	-11.2414	-197.4876	-0.9812	-1.4849	-4.9063	-9.124	-200.6642	-4.5417	-13.3587	-194.311
	3.168	-4.6367	-11.3363	-197.8924	-0.9333	-1.452	-4.879	-9.3073	-200.6511	-4.3945	-13.3652	-195.1337
	3.184	-5.1878	-10.955	-199.1162	-0.946	-1.282	-5.7296	-9.1313	-201.7543	-4.646	-12.7786	-196.4781
	3.2	-5.4924	-11.1121	-199.3732	-0.9708	-1.2837	-6.0676	-9.1637	-202.3424	-4.9172	-13.0604	-196.404
	3.216	-5.9083	-10.5942	-200.735	-0.8771	-1.2442	-6.7536	-8.0986	-203.9035	-5.0631	-13.0898	-197.5664
	3.232	-5.788	-10.8614	-201.7482	-0.9473	-1.0945	-6.869	-8.7659	-205.0266	-4.7069	-12.9569	-198.4698
	3.248	-5.8482	-10.5482	-202.2336	-1.0173	-0.9624	-7.0357	-8.8432	-205.5964	-4.6606	-12.2531	-198.8708
	3.264	-6.2677	-10.9828	-203.1796	-0.9837	-0.7731	-7.7402	-9.5461	-206.2715	-4.7952	-12.4196	-200.0877
	3.28	-6.8622	-10.4688	-203.896	-0.8356	-0.9606	-8.5138	-8.1069	-207.0831	-5.2107	-12.8307	-200.7089
	3.296	-6.8873	-10.8577	-204.6045	-0.8827	-0.8183	-8.699	-8.9228	-207.8286	-5.0756	-12.7926	-201.3805
	3.312	-6.8664	-10.5794	-205.4472	-0.8797	-0.8951	-8.6636	-8.337	-208.9214	-5.0691	-12.8219	-201.973

Man5	time	pos(x)	pos(y)	pos(z)	el	az	x1	y1	z1	x2	y2	z2
	3.328	-7.4032	-10.2666	-205.9368	-0.9087	-0.7703	-9.1036	-8.6169	-208.9761	-5.7029	-11.9164	-202.8974
	3.344	-6.893	-10.5283	-207.0804	-0.8374	-0.9038	-8.7143	-8.2151	-210.3479	-5.0718	-12.8415	-203.8128
	3.36	-7.411	-10.3085	-208.01	-0.9295	-0.8105	-8.964	-8.6756	-211.0283	-5.858	-11.9414	-204.9918
	3.376	-7.4167	-10.3406	-208.9419	-0.8681	-0.6109	-9.5866	-8.8212	-212.0697	-5.2468	-11.86	-205.8142
	3.392	-7.9932	-10.2779	-209.5501	-0.9452	-0.6615	-9.7448	-8.9142	-212.623	-6.2416	-11.6416	-206.4773
	3.408	-7.6547	-11.2058	-210.3705	-0.9882	-0.2804	-9.3904	-10.706	-213.1119	-5.919	-11.7057	-207.629
	3.424	-7.7516	-11.1871	-211.5454	-0.972	-0.3346	-9.7625	-10.488	-214.6652	-5.7407	-11.8862	-208.4255
	3.44	-8.024	-11.4943	-212.3799	-0.9963	-0.1592	-9.9697	-11.1818	-215.4243	-6.0783	-11.8067	-209.3355
	3.456	-8.1752	-11.127	-213.1458	-0.964	-0.1398	-10.1971	-10.8426	-216.0873	-6.1534	-11.4114	-210.2043
	3.472	-7.566	-11.2034	-214.282	-0.8345	-0.3535	-10.5543	-10.1007	-217.7966	-4.5776	-12.3061	-210.7673
	3.488	-7.5309	-11.6738	-214.7265	-0.9823	-0.2346	-9.5127	-11.2001	-217.7797	-5.5491	-12.1474	-211.6732
	3.504	-7.4382	-11.4238	-216.2377	-1.0114	-0.1964	-9.2301	-11.0672	-219.156	-5.6462	-11.7804	-213.3194
	3.52	-7.5075	-11.0111	-217.4152	-1.0678	-0.0638	-9.2711	-10.8984	-220.6267	-5.744	-11.1237	-214.2037
	3.536	-7.676	-11.4547	-217.9845	-1.0164	0.0316	-9.6326	-11.5166	-221.1464	-5.7194	-11.3929	-214.8225
	3.552	-6.8003	-11.8228	-218.9116	-1.0481	-0.0016	-8.6021	-11.8199	-222.0387	-4.9984	-11.8256	-215.7844
	3.568	-7.1406	-11.9454	-220.343	-1.1089	-0.2095	-8.8524	-11.5814	-223.8587	-5.4287	-12.3094	-216.8272
	3.584	-7.0265	-11.7548	-221.1111	-1.0518	-0.1933	-8.8953	-11.389	-224.4444	-5.1578	-12.1206	-217.7779
	3.6	-7.0397	-12.159	-221.9791	-1.1734	-0.1432	-8.3152	-11.9751	-225.0495	-5.7642	-12.3429	-218.9086
	3.616	-6.7013	-11.9567	-222.9002	-1.0002	-0.1015	-8.7086	-11.7524	-226.0441	-4.6941	-12.1611	-219.7564
	3.632	-6.4572	-12.3961	-224.3248	-0.96	0.6311	-7.9166	-13.4626	-226.9064	-4.9979	-11.3296	-221.7433
	3.648	-6.3799	-12.6604	-224.6612	-0.856	0.8037	-7.7576	-14.0896	-226.9483	-5.0021	-11.2312	-222.3741
	3.664	-5.4026	-13.0734	-226.2527	-0.9278	0.9302	-6.4798	-14.5185	-228.6587	-4.3254	-11.6282	-223.8467
	3.68	-5.6148	-12.872	-226.8321	-0.9058	0.959	-6.8186	-14.5877	-229.5052	-4.411	-11.1563	-224.159
	3.696	-5.3779	-12.9923	-227.9498	-0.8227	0.9681	-6.6478	-14.8379	-230.3639	-4.1081	-11.1467	-225.5358
	3.712	-4.4791	-13.3295	-229.0811	-0.8828	0.7506	-5.9078	-14.662	-231.4577	-3.0503	-11.997	-226.7046
	3.728	-4.81	-12.3306	-230.4449	-0.8542	0.9344	-6.0428	-13.9989	-232.8265	-3.5772	-10.6622	-228.0634
	3.744	-3.8888	-12.5759	-231.3071	-0.8131	0.6721	-5.732	-14.0426	-233.7967	-2.0456	-11.1091	-228.8175
	3.76	-2.7232	-13.156	-231.8665	-0.9014	0.7164	-4.1252	-14.3768	-234.2161	-1.3211	-11.9352	-229.517
	3.776	-1.7545	-13.4131	-232.9034	-0.8682	1.0122	-2.8083	-15.0991	-235.2515	-0.7007	-11.7271	-230.5553
	3.792	-1.3109	-12.511	-234.7363	-0.87	1.0138	-2.2962	-14.0934	-236.9459	-0.3255	-10.9287	-232.5266
	3.808	-0.6108	-13.2735	-235.2387	-0.8351	1.0222	-1.7403	-15.1218	-237.6318	0.5188	-11.4253	-232.8456
	3.824	-0.4197	-13.0489	-236.6287	-0.8344	1.1171	-1.3071	-14.8686	-238.8621	0.4677	-11.2292	-234.3953
	3.84	0.3798	-12.3639	-237.5993	-0.823	1.2617	-0.2679	-14.3923	-239.8952	1.0276	-10.3356	-235.3034
	3.856	1.2366	-12.5261	-238.7051	-0.6595	1.3387	0.6581	-14.9738	-240.6551	1.815	-10.0783	-236.7551
	3.872	2.6131	-12.9372	-239.7835	-0.6553	1.3086	2.0626	-14.9882	-241.4157	3.1635	-10.8862	-238.1513
	3.888	3.2686	-13.1848	-240.5921	-0.7551	1.2328	2.5405	-15.2565	-242.6589	3.9968	-11.1131	-238.5254
	3.904	3.7287	-11.8399	-241.5324	-1.0001	1.3305	3.4376	-13.0274	-243.4369	4.0197	-10.6524	-239.6278
	3.92	4.3718	-12.1679	-242.7817	-0.8834	1.3954	4.0709	-13.8653	-244.8817	4.6726	-10.4705	-240.6817
	3.936	6.3829	-12.1595	-244.1518	-0.7138	1.4723	6.1657	-14.3574	-246.0648	6.6001	-9.9615	-242.2388
	3.952	6.7231	-11.844	-244.8217	-0.8042	1.542	6.663	-13.9309	-246.9894	6.7832	-9.757	-242.654
	3.968	7.7771	-11.5482	-245.9388	-0.9349	1.5949	7.8193	-13.2991	-248.3112	7.7349	-9.7974	-243.5665
	3.984	8.0928	-11.2289	-246.7128	-0.8194	1.4052	7.785	-13.0701	-248.7112	8.4005	-9.3877	-244.7145
	4	8.8849	-11.1342	-247.9447	-0.8481	1.664	9.0498	-12.8991	-249.9545	8.72	-9.3694	-245.9348
	4.016	10.5324	-10.8971	-248.8584	-0.8343	1.9683	11.3062	-12.7402	-251.063	9.7585	-9.054	-246.6538
	4.032	10.4695	-10.9585	-249.0422	-0.7079	2.0702	11.5005	-12.8483	-250.8848	9.4384	-9.0687	-247.1995
	4.048	11.207	-10.7358	-250.4533	-0.7247	2.2507	12.6702	-12.5458	-252.5139	9.7437	-8.9259	-248.3927
	4.064	12.2173	-9.9803	-251.1886	-0.6142	2.1253	13.6361	-12.271	-253.0887	10.7985	-7.6896	-249.2886
	4.08	13.0134	-9.5304	-253.4808	-0.6744	2.3253	15.0534	-11.7007	-255.862	10.9733	-7.3601	-251.0996
	4.096	13.5712	-8.7484	-254.4702	-0.91	2.4859	15.1301	-9.9475	-257	12.0122	-7.5493	-251.9403
	4.112	15.9785	-7.9662	-255.0449	-0.9987	2.122	16.8198	-9.3348	-257.5396	15.1373	-6.5976	-252.5501
	4.128	16.7982	-7.9219	-256.0954	-1.222	2.8554	17.7632	-8.2059	-258.8612	15.8332	-7.6379	-253.3297
	4.144	18.1225	-7.3036	-256.7434	-1.1477	2.603	19.2128	-7.9552	-259.5641	17.0321	-6.6521	-253.9227
	4.16	18.487	-6.5368	-257.6141	-1.0238	2.9912	20.1453	-6.788	-260.3681	16.8287	-6.2856	-254.8602
	4.176	19.5248	-6.9928	-258.0921	-1.1856	2.8819	20.5928	-7.2765	-260.8179	18.4568	-6.7091	-255.3663
	4.192	19.4631	-6.1006	-258.7532	-1.0224	3.0833	21.1536	-6.1992	-261.5255	17.7725	-6.002	-255.9809
	4.208	20.8334	-7.0682	-258.5064	-1.2654	-3.0562	21.7047	-6.9936	-261.2806	19.9621	-7.1427	-255.7322
	4.224	21.1985	-6.0581	-259.7007	-1.0912	2.9734	22.7253	-6.3174	-262.6784	19.6716	-5.7988	-256.7229
	4.24	21.9529	-5.6422	-261.1169	-1.025	3.0792	23.898	-5.7636	-264.3256	20.0078	-5.5208	-257.9082
	4.256	22.5521	-5.8198	-261.2793	-1.0745	-2.9221	24.3339	-5.4224	-264.6503	20.7704	-6.2172	-257.9084
	4.272	23.427	-4.5238	-262.7984	-1.1398	-2.9211	24.7473	-4.2279	-265.7409	22.1067	-4.8196	-259.8558
	4.288	24.1737	-4.9184	-262.9959	-1.1159	-3.0043	25.7625	-4.699	-266.2746	22.585	-5.1379	-259.7171
	4.304	24.9563	-3.8145	-264.2289	-1.0693	-2.0666	26.7237	-2.7672	-267.9763	23.1889	-4.8618	-260.4815
	4.32	24.8899	-3.1593	-264.844	-1.0117	-2.8151	26.9432	-2.4641	-268.3084	22.8365	-3.8545	-261.3797
	4.336	25.9889	-3.518	-265.4461	-0.9603	-2.9749	28.2774	-3.133	-268.7629	23.7004	-3.903	-262.1292
	4.352	26.0059	-2.8118	-266.3764	-0.9825	-2.6727	28.0753	-1.7636	-269.8536	23.9366	-3.86	-262.8992
	4.368	26.9086	-3.1475	-266.6643	-0.9459	-2.596	28.9485	-1.9091	-269.9725	24.8686	-4.3858	-263.356

Man5											
time	pos(x)	pos(y)	pos(z)	el	az	x1	y1	z1	x2	y2	z2
4.384	26.9255	-3.1362	-267.3505	-1.044	-2.3628	28.477	-1.605	-271.0984	25.374	-4.6674	-263.6025
4.4	26.8106	-2.8194	-268.6166	-0.9165	-2.6488	29.073	-1.6045	-271.9644	24.5482	-4.0344	-265.2688
4.416	27.3715	-2.4638	-269.4878	-0.9659	-2.565	29.3763	-1.1601	-272.9465	25.3667	-3.7675	-266.029
4.432	28.3611	-2.6131	-270.2827	-0.8626	-2.5551	30.8822	-0.9379	-273.8171	25.84	-4.2883	-266.7484
4.448	28.2441	-2.3275	-271.2414	-0.8327	-2.74	30.8652	-1.2144	-274.3723	25.6231	-3.4406	-268.1105
4.464	28.8348	-2.9283	-271.9296	-0.8744	-2.6923	31.2378	-1.7697	-275.12	26.4318	-4.0869	-268.7391
4.48	28.7856	-2.3784	-273.2652	-0.9	-2.6024	31.2047	-0.931	-276.8178	26.3665	-3.8258	-269.7127
4.496	29.7321	-2.4381	-274.2657	-0.7975	-2.6219	32.4964	-0.8566	-277.5281	26.9679	-4.0196	-271.0032
4.512	29.2551	-2.2331	-275.2128	-0.7779	-2.5851	32.3194	-0.3268	-278.7682	26.1909	-4.1395	-271.6574
4.528	29.5722	-2.2864	-275.5318	-0.8575	-2.7848	32.2202	-1.2994	-278.7978	26.9242	-3.2735	-272.2658
4.544	30.2436	-2.2352	-277.4147	-0.8032	-2.7356	33.0657	-1.0222	-280.5975	27.4216	-3.4482	-274.2318
4.56	30.8369	-2.4357	-278.2433	-0.7851	-2.6979	33.6286	-1.1089	-281.3323	28.0452	-3.7625	-275.1542
4.576	29.5315	-2.1367	-278.9274	-0.8135	-2.9301	32.5285	-1.4933	-282.1703	26.5344	-2.7802	-275.6845
4.592	29.5019	-2.3685	-280.1521	-0.7105	-2.895	33.5048	-1.3608	-283.7037	25.4991	-3.3762	-276.6005
4.608	29.766	-2.1253	-281.2934	-0.7422	-2.9085	33.192	-1.3121	-284.5224	26.3401	-2.9385	-278.0643
4.624	30.0222	-2.3524	-282.1652	-0.7743	-2.8087	33.6435	-1.1004	-285.9128	26.4009	-3.6044	-278.4175
4.64	29.7718	-2.8602	-282.594	-0.8223	-2.9751	33.0716	-2.3055	-286.1967	26.472	-3.4148	-278.9913
4.656	30.4563	-2.8029	-284.35	-0.8719	-2.9411	33.0575	-2.2743	-287.5084	27.8551	-3.3316	-281.1916
4.672	30.1342	-3.3929	-285.0911	-0.9008	-2.6634	32.5193	-2.1568	-288.4818	27.7492	-4.6291	-281.7004
4.688	29.8883	-3.3647	-286.489	-0.9023	-2.7367	32.5267	-2.234	-290.1231	27.25	-4.4954	-282.855

Manta											
6	v1=										
time	pos(x)	pos(y)	pos(z)	el	az	x1	y1	z1	x2	y2	z2
0	0	0	0	-1.4203	-2.5216	0.1816	0.1296	-1.4708	-0.1816	-0.1296	1.4708
0.016	-0.1557	-0.1123	-2.2927	-1.441	2.7825	0.0956	-0.2067	-4.3492	-0.407	-0.018	-0.2361
0.032	-0.2549	-0.3933	-5.2909	-1.2989	2.3423	0.2397	-0.9019	-7.835	-0.7495	0.1152	-2.7467
0.048	0.144	-0.1253	-7.0072	-1.1957	2.4322	0.9766	-0.8402	-9.7942	-0.6887	0.5895	-4.2202
0.064	0.0243	-0.4631	-8.978	-1.2552	1.9841	0.4353	-1.4003	-12.1128	-0.3867	0.4742	-5.8432
0.08	0.0692	-1.018	-11.5023	-1.286	1.7885	0.2777	-1.9609	-14.8003	-0.1394	-0.0752	-8.2043
0.096	0.3593	-0.842	-13.0094	-1.3135	1.6875	0.4468	-1.5881	-15.8639	0.2718	-0.0959	-10.1549
0.112	0.1691	-0.5915	-14.1465	-1.2599	1.9594	0.512	-1.4291	-16.9629	-0.1737	0.246	-11.3301
0.128	0.3528	-1.1161	-16.0425	-1.3035	2.146	0.7413	-1.7154	-18.6505	-0.0357	-0.5167	-13.4344
0.144	0.8323	-0.9254	-16.6003	-1.274	2.0358	1.1686	-1.5957	-19.0523	0.4959	-0.255	-14.1482
0.16	0.7078	-1.6895	-19.3832	-1.2953	1.7229	0.7993	-2.286	-21.5184	0.6164	-1.0929	-17.248
0.176	0.4547	-1.3918	-18.9763	-1.2294	2.2714	1.0054	-2.0449	-21.3809	-0.096	-0.7387	-16.5717
0.192	0.196	-1.3846	-20.1306	-1.3096	1.768	0.3136	-1.9728	-22.3749	0.0785	-0.7964	-17.8863
0.208	0.2236	-1.61	-20.9473	-1.3801	2.5207	0.5472	-1.8414	-23.0083	-0.0999	-1.3786	-18.8863
0.224	0.2913	-1.4603	-21.8341	-1.3487	2.6476	0.7547	-1.7099	-24.1644	-0.1721	-1.2108	-19.5038
0.24	0.4458	-1.6514	-22.9239	-1.4901	2.6147	0.5985	-1.7402	-25.1074	0.2931	-1.5625	-20.7403
0.256	-0.0789	-1.2344	-22.8088	-1.4579	2.4378	0.1391	-1.4195	-25.3304	-0.297	-1.0493	-20.2871
0.272	0.2776	-1.4691	-23.57	-1.5165	0.9925	0.2061	-1.5787	-25.9789	0.3492	-1.3596	-21.1611
0.288	0.2619	-1.421	-24.9942	-1.4201	2.6834	0.5816	-1.5787	-27.3415	-0.0578	-1.2634	-22.6469
0.304	0.2683	-1.0748	-25.0731	-1.4237	2.7733	0.5938	-1.2004	-27.4284	-0.0573	-0.9492	-22.7178
0.32	0.7397	-1.3413	-26.1587	-1.445	2.3652	0.9831	-1.5804	-28.8562	0.4964	-1.1023	-23.4612
0.336	0.6296	-1.2926	-27.2884	-1.3958	2.5612	0.9647	-1.5123	-29.5544	0.2946	-1.0729	-25.0224
0.352	0.4943	-1.1353	-27.7366	-1.3942	2.4239	0.7672	-1.3736	-29.7669	0.2214	-0.8971	-25.7063
0.368	0.7582	-1.1059	-28.3267	-1.5236	0.1536	0.6491	-1.1228	-30.6628	0.8674	-1.089	-25.9905
0.384	0.4572	-1.2144	-29.156	-1.4124	2.9715	0.7933	-1.2721	-31.2914	0.1211	-1.1567	-27.0206
0.4	-0.1774	-0.8091	-29.3882	-1.3662	1.5028	-0.2099	-1.2858	-31.6913	-0.1449	-0.3324	-27.0851
0.416	0.4771	-1.4135	-30.5438	-1.4247	3.0596	0.8048	-1.4405	-32.7791	0.1494	-1.3866	-28.3086
0.432	0.2305	-1.0352	-30.766	-1.3782	2.4178	0.5575	-1.3243	-33.0046	-0.0965	-0.7462	-28.5273
0.448	0.0356	-1.2411	-31.9781	-1.4811	2.5995	0.2059	-1.3436	-34.1894	-0.1347	-1.1385	-29.7668
0.464	-0.0529	-1.1733	-32.8177	-1.3359	2.2922	0.2865	-1.5592	-34.9652	-0.3923	-0.7875	-30.6702
0.48	0.0463	-0.7152	-33.1692	-1.3138	2.1967	0.4603	-1.2879	-35.8586	-0.3677	-0.1425	-30.4798
0.496	-0.2976	-0.8682	-33.957	-1.4383	2.3188	-0.0787	-1.1041	-36.3713	-0.5164	-0.6324	-31.5428
0.512	-0.6376	-1.2	-35.2323	-1.332	2.5508	-0.2301	-1.4733	-37.2477	-1.0451	-0.9267	-33.2169
0.528	-1.869	-1.1363	-35.6546	-1.3639	2.3299	-1.5319	-1.4918	-37.9884	-2.2062	-0.7809	-33.3209
0.544	-1.8491	-1.469	-37.0927	-1.5276	0.1051	-1.948	-1.4795	-39.3953	-1.7501	-1.4586	-34.7901
0.56	-2.0627	-1.4861	-37.3566	-1.437	2.5624	-1.757	-1.6861	-40.0702	-2.3684	-1.2862	-34.6431
0.576	-1.6576	-1.5346	-38.3934	-1.5408	0.6713	-1.7072	-1.574	-40.5035	-1.6081	-1.4953	-36.2834
0.592	-1.6346	-1.5322	-39.3566	-1.4559	2.0121	-1.5199	-1.775	-41.6823	-1.7492	-1.2895	-37.0309
0.608	-1.9038	-1.6479	-40.0258	-1.4342	2.1502	-1.7274	-1.9175	-42.3695	-2.0802	-1.3784	-37.6821
0.624	-1.8033	-1.7766	-40.9352	-1.4651	2.4822	-1.589	-1.9426	-43.4907	-2.0175	-1.6106	-38.3797
0.64	-1.6928	-1.6878	-41.3857	-1.4291	2.8259	-1.3866	-1.7878	-43.6427	-1.999	-1.5879	-39.1286
0.656	-2.0153	-1.91	-42.7307	-1.4809	2.2636	-1.8832	-2.0691	-45.0245	-2.1474	-1.7509	-40.4368

Manó	time	pos(x)	pos(y)	pos(z)	el	az	x1	y1	z1	x2	y2	z2
	0.672	-2.8585	-1.6238	-43.2156	-1.5326	0.5766	-2.9469	-1.6813	-45.9758	-2.7701	-1.5663	-40.4554
	0.688	-2.8743	-1.8081	-43.9538	-1.4483	1.3187	-2.9549	-2.1206	-46.575	-2.7938	-1.4955	-41.3326
	0.704	-3.1724	-2.4748	-44.6817	-1.4835	1.3573	-3.2228	-2.707	-47.3974	-3.1221	-2.2426	-41.9659
	0.72	-3.2568	-2.976	-45.2737	-1.4155	1.9425	-3.1296	-3.3023	-47.5118	-3.384	-2.6496	-43.0356
	0.736	-2.732	-2.4266	-45.4956	-1.4547	2.057	-2.5762	-2.7215	-48.3558	-2.8878	-2.1318	-42.6355
	0.752	-2.4402	-2.6957	-46.5892	-1.4827	0.2309	-2.6242	-2.739	-48.7291	-2.2562	-2.6524	-44.4493
	0.768	-2.4322	-2.827	-47.3626	-1.4819	1.9351	-2.3543	-3.0312	-49.8144	-2.51	-2.6228	-44.9109
	0.784	-2.2353	-1.5699	-47.8986	-1.3259	0.4997	-2.798	-1.8771	-50.4641	-1.6726	-1.2627	-45.3332
	0.8	-2.3088	-2.9379	-50.5789	-1.2194	0.0621	-3.1211	-2.9885	-52.7992	-1.4965	-2.8874	-48.3586
	0.816	-2.8276	-2.4024	-50.8482	-1.313	-0.1422	-3.4284	-2.3163	-53.1498	-2.2269	-2.4884	-48.5466
	0.832	-2.9147	-2.1084	-51.4492	-1.1885	-0.1352	-3.7414	-1.9959	-53.524	-2.088	-2.2208	-49.3744
	0.848	-2.807	-2.306	-52.2162	-1.1458	-0.0149	-3.7936	-2.2913	-54.3963	-1.8203	-2.3207	-50.0361
	0.864	-3.0868	-2.5137	-52.8306	-1.0274	-0.0041	-4.3788	-2.5085	-54.9698	-1.7947	-2.519	-50.6915
	0.88	-2.4265	-2.279	-53.3696	-0.9092	-0.0602	-3.9076	-2.1897	-55.2751	-0.9454	-2.3683	-51.4464
	0.896	-2.6673	-2.5851	-54.5531	-1.0245	-0.0211	-3.8833	-2.5594	-56.5535	-1.4513	-2.6108	-52.5528
	0.912	-3.2197	-2.7435	-55.3774	-1.0135	-0.095	-4.5454	-2.6173	-57.5141	-1.8941	-2.8698	-53.2407
	0.928	-3.228	-2.5385	-56.3026	-0.9652	-0.0239	-4.7204	-2.5028	-58.4588	-1.7357	-2.5742	-54.1464
	0.944	-3.2086	-2.753	-57.5158	-1.0614	0.0455	-4.5222	-2.8128	-59.8698	-1.895	-2.6933	-55.1619
	0.96	-3.1442	-2.8126	-58.3664	-0.9569	-0.1084	-4.5443	-2.6603	-60.3648	-1.7442	-2.965	-56.368
	0.976	-3.3529	-2.7574	-58.999	-0.9161	-0.0918	-4.9428	-2.6111	-61.0791	-1.7629	-2.9038	-56.9188
	0.992	-3.1533	-2.5183	-59.521	-0.984	-0.0875	-4.495	-2.4006	-61.5465	-1.8117	-2.6359	-57.4954
	1.008	-3.171	-2.789	-60.3932	-0.9035	-0.0196	-4.8762	-2.7555	-62.558	-1.4659	-2.8225	-58.2285
	1.024	-3.7162	-2.874	-61.4473	-1.0087	0.0501	-5.1212	-2.9445	-63.6806	-2.3113	-2.8036	-59.214
	1.04	-3.9964	-3.4332	-62.5116	-0.995	0.0342	-5.4385	-3.4824	-64.7346	-2.5542	-3.3839	-60.2886
	1.056	-4.1854	-3.1822	-63.1347	-1.0191	-0.0561	-5.4258	-3.1125	-65.1535	-2.9449	-3.2519	-61.1159
	1.072	-4.2839	-2.6385	-63.6022	-1.0382	-0.0955	-5.4788	-2.5241	-65.6387	-3.089	-2.753	-61.5657
	1.088	-4.7146	-2.5497	-64.8217	-1.1747	0.0264	-5.5712	-2.5723	-66.8709	-3.8579	-2.5711	-62.7725
	1.104	-5.0161	-2.4113	-65.3601	-1.1977	0.298	-5.8934	-2.6808	-67.7049	-4.1388	-2.1419	-63.0153
	1.12	-4.3588	-2.4906	-66.5613	-1.0784	0.0846	-5.5465	-2.5913	-68.7827	-3.1712	-2.3899	-64.3398
	1.136	-5.0432	-2.5622	-67.3978	-1.0976	0.2662	-6.3681	-2.9234	-70.08	-3.7183	-2.2009	-64.7156
	1.152	-5.3459	-2.3068	-67.6606	-1.0776	0.0949	-6.612	-2.4273	-70.027	-4.0797	-2.1863	-65.2943
	1.168	-5.3142	-2.3752	-68.4849	-1.1557	0.1275	-6.2393	-2.4938	-70.6012	-4.389	-2.2567	-66.3686
	1.184	-5.2897	-2.5586	-69.2497	-1.0783	-0.0974	-6.4499	-2.4453	-71.4223	-4.1294	-2.6719	-67.0771
	1.2	-5.9637	-2.1167	-70.1186	-1.2913	0.1506	-6.6384	-2.2191	-72.4964	-5.289	-2.0143	-67.7409
	1.216	-5.9633	-2.1392	-71.5584	-1.4775	0.6973	-6.1334	-2.2817	-73.9292	-5.7932	-1.9968	-69.1875
	1.232	-6.1887	-2.3388	-72.2373	-1.5263	-0.2209	-6.2894	-2.3162	-74.5544	-6.0881	-2.3613	-69.9201
	1.248	-5.9231	-2.4505	-72.8698	-1.3536	0.383	-6.3782	-2.6339	-75.0929	-5.468	-2.2671	-70.6467
	1.264	-6.0834	-2.5958	-73.7041	-1.4357	0.8487	-6.29	-2.8305	-76.0039	-5.8768	-2.3612	-71.4043
	1.28	-6.1984	-2.4652	-74.4892	-1.4343	0.03	-6.5196	-2.4748	-76.829	-5.8773	-2.4556	-72.1494
	1.296	-6.1188	-2.4234	-74.9059	-1.3837	-1.1047	-6.3053	-2.0526	-77.0984	-5.9323	-2.7941	-72.7134
	1.312	-5.8462	-2.1854	-76.0601	-1.5344	2.0438	-5.8053	-2.2653	-78.5257	-5.8871	-2.1055	-73.5944
	1.328	-5.6377	-2.4702	-77.0182	-1.3418	-0.8492	-5.9752	-2.0866	-79.2109	-5.3001	-2.8538	-74.8256
	1.344	-4.9566	-2.3545	-78.1236	-1.35	-0.6519	-5.3638	-2.0437	-80.4058	-4.5494	-2.6653	-75.8413
	1.36	-4.3354	-2.703	-79.0044	-1.1744	-0.4785	-5.0559	-2.3293	-80.9436	-3.615	-3.0767	-77.0652
	1.376	-4.0972	-2.6802	-79.5117	-1.3519	-0.7191	-4.4038	-2.4118	-81.3432	-3.7906	-2.9485	-77.6802
	1.392	-4.4326	-2.3972	-80.2037	-1.3951	-0.6579	-4.7667	-2.139	-82.5828	-4.0984	-2.6554	-77.8246
	1.408	-4.2943	-2.2256	-80.8442	-1.3804	3.045	-3.7417	-2.2792	-83.725	-4.847	-2.1721	-77.9634
	1.424	-4.2999	-2.5362	-81.7044	-1.4587	-1.5602	-4.4303	-2.2449	-84.2927	-4.2968	-2.8275	-79.1162
	1.44	-4.6923	-1.5185	-82.2326	-1.3259	-1.9754	-4.4336	-0.9144	-84.8618	-4.951	-2.1225	-79.6034
	1.456	-4.2257	-1.2996	-82.8242	-1.2411	-1.4359	-4.3305	-0.5282	-85.099	-4.121	-2.0711	-80.5493
	1.472	-3.9977	-1.1337	-83.3033	-1.3378	-2.2636	-3.618	-0.6762	-85.8092	-4.3775	-1.5911	-80.7975
	1.488	-4.0692	-0.9516	-84.0072	-1.2955	-1.9356	-3.8185	-0.2951	-86.4947	-4.32	-1.6081	-81.5196
	1.504	-3.2492	-1.035	-84.8244	-1.1564	-2.4303	-2.4131	-0.3145	-87.3336	-4.0853	-1.7555	-82.3152
	1.52	-3.3911	-0.7151	-85.7905	-1.1817	-2.3742	-2.7349	-0.0821	-88.0144	-4.0473	-1.3482	-83.5667
	1.536	-3.4711	0.1151	-86.0283	-1.1831	-2.372	-2.8757	0.692	-88.0588	-4.0666	-0.4618	-83.9979
	1.552	-3.9105	-0.0578	-86.8756	-0.9926	-2.1892	-3.2051	0.9337	-88.7404	-4.6159	-1.0492	-85.0109
	1.568	-3.3548	-0.0908	-87.6435	-0.9748	-2.3323	-2.512	0.7934	-89.4443	-4.1976	-0.9749	-85.8427
	1.584	-2.8433	-0.4207	-88.9803	-1.0893	-2.1452	-2.2385	0.5138	-91.1105	-3.448	-1.3551	-86.85
	1.6	-2.5553	-0.0077	-88.9523	-1.1027	-2.391	-1.7615	0.7327	-91.0994	-3.3491	-0.7481	-86.8051
	1.616	-2.7953	0.7827	-89.2583	-1.0253	-2.618	-1.5978	1.4742	-91.5365	-3.9928	0.0913	-86.9801
	1.632	-2.8026	-0.1322	-90.8442	-0.9283	-2.4386	-1.7919	0.7242	-92.6143	-3.8133	-0.9886	-89.074
	1.648	-2.6389	-0.314	-91.5482	-0.7781	-2.5522	-1.4186	0.502	-92.9949	-3.8592	-1.13	-90.1015
	1.664	-2.6041	0.1169	-92.4996	-0.6797	-2.4666	-1.1748	1.261	-93.9792	-4.0334	-1.0272	-91.02
	1.68	-2.2836	0.2159	-93.6142	-0.6867	-2.3641	-1.0285	1.4513	-95.0579	-3.5387	-1.0196	-92.1705
	1.696	-2.1994	0.6844	-94.0979	-0.6027	-2.5831	-0.3332	1.8506	-95.6123	-4.0657	-0.4818	-92.5836
	1.712	-2.1939	0.8279	-94.84	-0.7526	-2.5565	-0.7008	1.8171	-96.5173	-3.6871	-0.1612	-93.1627

Manó	time	pos(x)	pos(y)	pos(z)	el	az	x1	y1	z1	x2	y2	z2
	1.728	-2.0852	0.8714	-95.5822	-0.8195	-2.7591	-0.4531	1.528	-97.4656	-3.7172	0.2148	-93.6988
	1.744	-2.1001	0.7592	-95.9882	-0.9416	-2.6686	-0.825	1.4118	-97.956	-3.3751	0.1067	-94.0204
	1.76	-2.1664	0.9892	-96.814	-0.826	-2.8099	-0.5204	1.556	-98.7023	-3.8123	0.4224	-94.9257
	1.776	-1.9662	0.6871	-98.0304	-0.85	-2.7537	-0.1977	1.4097	-100.2053	-3.7348	-0.0355	-95.8556
	1.792	-2.3147	0.548	-98.7551	-0.8653	-2.6228	-0.9016	1.3549	-100.6655	-3.7279	-0.2588	-96.8446
	1.808	-2.7396	0.7798	-99.368	-0.8737	-2.6828	-1.2121	1.5343	-101.4028	-4.2671	0.0254	-97.3332
	1.824	-1.9786	1.0404	-99.8059	-1.0039	-2.4753	-1.0472	1.7727	-101.667	-2.91	0.3081	-97.9448
	1.84	-3.1201	1.7022	-100.4392	-0.9022	-2.7371	-1.9745	2.1926	-102.0167	-4.2658	1.2118	-98.8617
	1.856	-2.5131	1.929	-101.5744	-0.9097	-3.0044	-0.7562	2.1716	-103.8547	-4.2701	1.6864	-99.2941
	1.872	-2.0318	1.4408	-102.4185	-1.0534	-2.9492	-0.7173	1.6969	-104.7718	-3.3463	1.1847	-100.0652
	1.888	-1.7236	1.2909	-103.4364	-1.3342	-2.8563	-1.2251	1.4371	-105.5912	-2.2221	1.1447	-101.2815
	1.904	-1.9476	1.1117	-104.1257	-1.2654	3.1113	-1.0739	1.0853	-106.8985	-2.8213	1.1382	-101.3529
	1.92	-2.2472	1.3633	-104.649	-1.0586	-3.0265	-0.9323	1.5153	-107.0031	-3.562	1.2113	-102.2949
	1.936	-2.1822	1.1332	-105.5191	-1.0576	-2.9525	-0.7345	1.4102	-108.1348	-3.6299	0.8562	-102.9034
	1.952	-1.1571	0.6079	-106.8729	-1.1408	-3.0273	-0.1256	0.7264	-109.1366	-2.1887	0.4895	-104.6092
	1.968	-1.2704	0.3876	-107.5369	-1.4462	-2.5154	-1.0033	0.5808	-110.1684	-1.5375	0.1943	-104.9054
	1.984	-2.05	0.6171	-108.3846	-1.4289	-2.9183	-1.6952	0.6976	-110.9307	-2.4049	0.5365	-105.8386
	2	-1.4388	0.3092	-109.4087	-1.346	-2.9283	-0.8548	0.4357	-112.022	-2.0228	0.1827	-106.7954
	2.016	-1.9038	0.844	-109.9029	-1.3914	-2.9351	-1.4553	0.7501	-112.4299	-2.3523	0.938	-107.376
	2.032	-1.549	0.9046	-110.2965	-1.4586	-2.7687	-1.2966	1.0034	-112.7034	-1.8015	0.8059	-107.8896
	2.048	-1.3941	0.4873	-111.3644	-1.4508	-2.8241	-1.0991	0.5842	-113.9401	-1.6891	0.3903	-108.7888
	2.064	-1.8389	0.3843	-111.7935	-1.3456	-2.7773	-1.2727	0.1684	-114.4388	-2.405	0.6001	-109.1481
	2.08	-1.8397	0.7953	-112.7197	-1.4626	-3.1176	-1.5612	0.802	-115.2852	-2.1182	0.7886	-110.1542
	2.096	-1.7038	0.5002	-113.9863	-1.3998	2.7529	-1.356	0.3578	-116.162	-2.0516	0.6426	-111.8106
	2.112	-0.9538	-0.0178	-114.808	-1.2995	2.1803	-0.571	-0.5661	-117.2116	-1.3365	0.5304	-112.4044
	2.128	-1.3171	-0.1046	-115.8198	-1.2624	2.3963	-0.757	-0.6216	-118.2129	-1.8773	0.4124	-113.4268
	2.144	-1.1692	-0.5446	-116.6978	-1.2492	1.5476	-1.1876	-1.34	-119.0862	-1.1507	0.2508	-114.3095
	2.16	-1.7975	-0.339	-117.0688	-1.1223	1.9708	-1.3273	-1.4513	-119.5785	-2.2677	0.7732	-114.5591
	2.176	-1.4201	-0.1243	-117.6645	-1.1319	2.149	-0.7248	-1.1897	-120.3744	-2.1154	0.9412	-114.9547
	2.192	-0.8491	-0.2989	-118.8697	-0.9417	1.8277	-0.4447	-1.8385	-121.0574	-1.2535	1.2408	-116.6819
	2.208	-0.9665	-0.3944	-120.0155	-0.9576	1.7779	-0.6283	-2.0038	-122.3528	-1.3047	1.215	-117.6783
	2.224	-1.4654	-0.3408	-120.4537	-0.9387	1.7833	-1.1183	-1.9495	-122.7011	-1.8125	1.2679	-118.2062
	2.24	-0.9254	-1.3569	-121.0653	-1.0403	1.8817	-0.5493	-2.5274	-123.1613	-1.3015	-0.1864	-118.9692
	2.256	-1.0968	-0.7704	-122.5602	-0.9837	1.588	-1.0753	-2.025	-124.4461	-1.1183	0.4842	-120.6743
	2.272	-0.528	-0.7988	-123.9626	-0.9053	1.6783	-0.3462	-2.4835	-126.1214	-0.7099	0.886	-121.8038
	2.288	-0.5249	-0.5646	-124.7094	-0.84	1.7454	-0.1972	-2.4228	-126.8144	-0.8527	1.2935	-122.6043
	2.304	-0.5998	-1.2008	-125.2036	-0.8807	1.8098	-0.1667	-2.9781	-127.4196	-1.0329	0.5765	-122.9876
	2.32	-0.4269	-1.3625	-126.4207	-0.8525	1.6155	-0.353	-3.014	-128.312	-0.5009	0.289	-124.5294
	2.336	-0.6994	-1.0767	-127.1071	-0.8066	1.5747	-0.6924	-2.8871	-128.9959	-0.7065	0.7338	-125.2184
	2.352	-0.1361	-1.6998	-128.4612	-0.8975	1.6648	0.0129	-3.2805	-130.4518	-0.2851	-0.1191	-126.4705
	2.368	-0.2788	-0.8872	-128.8696	-0.811	1.7128	-0.012	-2.7529	-130.8535	-0.5456	0.9786	-126.8857
	2.384	0.2462	-0.9957	-129.4888	-0.8589	1.6053	0.3048	-2.6932	-131.4571	0.1875	0.7017	-127.5205
	2.4	-0.0725	-2.2048	-131.0564	-0.8402	1.84	0.4364	-4.0491	-133.1915	-0.5814	-0.3605	-128.9213
	2.416	0.377	-2.4341	-131.668	-0.8357	1.8224	0.7794	-3.9993	-133.4555	-0.0254	-0.8689	-129.8806
	2.432	0.3495	-2.0874	-132.4706	-0.8164	1.6119	0.4241	-3.9018	-134.4028	0.2748	-0.273	-130.5385
	2.448	0.0027	-2.2574	-132.5041	-1.1701	1.8406	0.2911	-3.3	-135.0576	-0.2856	-1.2147	-129.9506
	2.464	-0.1889	-2.2129	-133.4697	-1.1233	1.5653	-0.1964	-3.5642	-136.2854	-0.1814	-0.8616	-130.6541
	2.48	0.2674	-2.2274	-134.6279	-1.1614	1.9329	0.6687	-3.2866	-137.238	-0.1338	-1.1683	-132.0179
	2.496	0.9123	-2.7615	-135.4413	-1.0729	1.912	1.3873	-4.0991	-138.0527	0.4373	-1.4239	-132.8298
	2.512	0.6339	-2.378	-136.3464	-1.1293	2.0484	1.2132	-3.4971	-139.0126	0.0547	-1.259	-133.6803
	2.528	0.6316	-2.48	-137.1339	-1.2304	2.141	1.1675	-3.3158	-139.9375	0.0956	-1.6441	-134.3303
	2.544	0.5526	-2.4191	-138.2984	-1.1197	2.3268	1.5302	-3.4559	-141.2401	-0.4251	-1.3823	-135.3566
	2.56	1.3977	-2.0787	-139.1782	-1.2648	1.8594	1.6626	-2.9706	-142.1235	1.1329	-1.1867	-136.233
	2.576	1.4311	-2.8019	-139.843	-1.3643	2.0277	1.691	-3.3305	-142.6552	1.1713	-2.2732	-137.0309
	2.592	1.0654	-2.4447	-140.6705	-1.4068	2.6811	1.4719	-2.6464	-143.413	0.6588	-2.2431	-137.9281
	2.608	1.7936	-1.7559	-141.7446	-1.3296	2.4164	2.3215	-2.2238	-144.6124	1.2656	-1.288	-138.8767
	2.624	1.6903	-1.7975	-142.7423	-1.3737	2.4666	2.1019	-2.127	-145.3821	1.2787	-1.4681	-140.1025
	2.64	2.2181	-1.7097	-143.7418	-1.5452	2.3543	2.2682	-1.76	-146.5074	2.1681	-1.6595	-140.9761
	2.656	2.1216	-1.724	-144.3758	-1.496	2.4877	2.2879	-1.8515	-147.1726	1.9553	-1.5966	-141.5789
	2.672	1.6112	-0.3485	-144.7452	-1.3577	3.1298	2.1954	-0.3553	-147.4451	1.027	-0.3416	-142.0454
	2.688	2.0278	0.0648	-145.9124	-1.3895	-2.8246	2.5179	0.2256	-148.7268	1.5377	-0.096	-143.0979
	2.704	2.6013	-0.9892	-146.7064	-1.3773	-2.6967	3.0855	-0.7584	-149.4438	2.1171	-1.2201	-143.9691
	2.72	2.4957	-0.459	-147.3073	-1.2642	-2.2982	3.0497	0.1634	-149.9391	1.9416	-1.0813	-144.6755
	2.736	2.4511	0.2687	-147.9927	-1.3603	3.072	3.0627	0.2261	-150.862	1.8395	0.3113	-145.1235
	2.752	2.8755	0.457	-148.7949	-1.1776	-2.5347	3.7222	1.0448	-151.2796	2.0288	-0.1309	-146.3101
	2.768	3.3142	0.9399	-149.693	-1.2403	-2.5601	4.0726	1.4383	-152.3384	2.5558	0.4414	-147.0475

Manó	time	pos(x)	pos(y)	pos(z)	el	az	x1	y1	z1	x2	y2	z2
	2.784	3.2178	0.7481	-150.471	-1.0816	-2.026	3.8722	2.0851	-153.2669	2.5634	-0.5889	-147.6751
	2.8	2.8375	1.0812	-151.6232	-1.015	-1.9527	3.4575	2.6246	-154.301	2.2176	-0.4622	-148.9454
	2.816	2.9903	1.818	-152.4892	-1.0229	-1.9522	3.634	3.4232	-155.3231	2.3465	0.2127	-149.6552
	2.832	2.5161	2.4256	-153.2414	-0.9601	-2.0353	3.4007	4.1909	-156.0626	1.6316	0.6602	-150.4202
	2.848	3.0294	2.8711	-153.8389	-0.9624	-1.8222	3.5466	4.8843	-156.8229	2.5123	0.8578	-150.8549
	2.864	2.6391	3.9189	-154.0442	-0.9617	-1.7845	3.0852	5.9745	-157.0595	2.1931	1.8633	-151.029
	2.88	3.5347	4.5782	-154.5596	-1.1349	-1.8071	3.8605	5.9312	-157.5473	3.2088	3.2253	-151.5719
	2.896	3.0713	4.7003	-155.3066	-0.9676	-1.7592	3.4467	6.6693	-158.2162	2.6959	2.7313	-152.397
	2.912	2.845	6.31	-156.0979	-1.0002	-1.8435	3.3136	7.9853	-158.8084	2.3764	4.6347	-153.3873
	2.928	3.5555	5.9698	-156.6238	-0.848	-1.8244	4.1187	8.1425	-159.1685	2.9923	3.7971	-154.0791
	2.944	3.6394	6.4224	-158.1484	-0.9043	-1.989	4.4872	8.33	-160.8022	2.7916	4.5149	-155.4946
	2.96	3.5768	5.8718	-158.7112	-0.7231	-1.8724	4.4642	8.7247	-161.3478	2.6893	3.019	-156.0746
	2.976	3.6972	6.6805	-159.4172	-0.8573	-1.7413	4.0649	8.8153	-161.9194	3.3296	4.5458	-156.9151
	2.992	3.5251	6.3339	-160.2756	-0.8174	-1.8646	4.2633	8.7734	-162.993	2.7869	3.9944	-157.5582
	3.008	3.8064	6.5016	-161.1211	-0.8493	-1.8546	4.4603	8.7436	-163.7757	3.1525	4.2597	-158.4665
	3.024	4.1167	6.0878	-161.9489	-0.7427	-1.7458	4.6428	9.064	-164.7237	3.5906	3.1117	-159.1741
	3.04	4.7841	5.7593	-162.9825	-0.7343	-1.7403	5.2479	8.4683	-165.4632	4.3204	3.0504	-160.5018
	3.056	4.7939	5.6374	-163.9563	-0.762	-1.7398	5.2505	8.3133	-166.5468	4.3374	2.9615	-161.3658
	3.072	4.3684	6.513	-164.8848	-0.7826	-1.6655	4.6302	9.2704	-167.6391	4.1066	3.7556	-162.1304
	3.088	4.759	6.4177	-165.6668	-0.8303	-1.6754	5.0332	9.0296	-168.54	4.4848	3.8058	-162.7936
	3.104	4.1649	6.8626	-166.9774	-0.8637	-1.676	4.4261	9.3363	-169.8885	3.9036	4.3889	-164.0663
	3.12	4.3801	6.0744	-167.8471	-0.9769	-1.6224	4.4779	7.9685	-170.6557	4.2824	4.1803	-165.0384
	3.136	4.1804	6.2115	-168.6576	-0.9477	-1.6131	4.27	8.3281	-171.6058	4.0907	4.0949	-165.7094
	3.152	4.1166	5.6319	-169.6111	-0.8203	-1.7144	4.4757	8.115	-172.3018	3.7575	3.1488	-166.9205
	3.168	4.5787	5.8682	-170.704	-0.9173	-1.615	4.6757	8.0619	-173.5714	4.4818	3.6745	-167.8366
	3.184	4.7845	5.8566	-171.0827	-0.6937	-1.6773	5.0617	8.4486	-173.2504	4.5074	3.2646	-168.9149
	3.2	5.0727	5.8593	-172.1901	-0.7221	-1.6463	5.2637	8.3843	-174.4207	4.8817	3.3342	-169.9596
	3.216	5.3592	5.729	-173.1607	-0.8229	-1.6205	5.472	7.9973	-175.6089	5.2464	3.4606	-170.7124
	3.232	5.5496	5.5319	-174.2284	-0.7636	-1.5397	5.4731	7.9909	-176.5835	5.6261	3.0729	-171.8733
	3.248	5.066	5.8635	-175.0291	-0.8773	-1.5809	5.0863	7.8843	-177.4606	5.0456	3.8427	-172.5977
	3.264	5.1192	4.554	-176.0371	-0.8917	-1.7868	5.5242	6.4003	-178.3787	4.7141	2.7076	-173.6955
	3.28	6.3297	4.9124	-177.0543	-1.0987	-1.9876	6.8702	6.133	-179.6689	5.7892	3.6917	-174.4398
	3.296	6.2415	4.4854	-178.0253	-1.1373	-1.7824	6.4958	5.669	-180.6404	5.9872	3.3019	-175.4101
	3.312	6.7138	4.4867	-179.0844	-1.1283	-1.7003	6.8802	5.7645	-181.8041	6.5474	3.209	-176.3647
	3.328	6.3355	4.6522	-179.7949	-1.2276	-2.38	7.081	5.3629	-182.677	5.5901	3.9414	-176.9129
	3.344	5.9781	3.8256	-180.3352	-1.2091	-1.9818	6.3318	4.637	-182.6748	5.6245	3.0142	-177.9957
	3.36	6.3951	2.4937	-181.7402	-1.1167	-2.1566	7.1134	3.5762	-184.4015	5.6769	1.4113	-179.079
	3.376	7.1293	2.7851	-182.6435	-1.227	-2.1462	7.6782	3.6313	-185.4604	6.5804	1.9389	-179.8266
	3.392	6.8495	2.5714	-183.7742	-1.3429	-2.9153	7.5074	2.4199	-186.6847	6.1916	2.7229	-180.8637
	3.408	6.7734	1.8006	-184.3064	-1.3623	-2.1612	7.133	2.3372	-187.3587	6.4138	1.2641	-181.254
	3.424	7.3272	1.5037	-185.7175	-1.2868	-2.6199	8.072	1.0755	-188.6611	6.5823	1.9319	-182.7738
	3.44	7.1406	1.3828	-186.1569	-1.3225	-2.3681	7.6999	0.8366	-189.2405	6.5812	1.929	-183.0733
	3.456	7.3196	1.5123	-187.19	-1.1286	-2.1583	8.075	0.378	-190.0684	6.5642	2.6466	-184.3116
	3.472	7.4231	1.2137	-188.0905	-1.2232	-2.5703	8.2593	0.6761	-190.8341	6.5868	1.7513	-185.3469
	3.488	7.8709	0.8029	-188.6083	-1.0743	-2.3598	8.9751	-0.2935	-191.4806	6.7666	1.8993	-185.736
	3.504	8.343	-0.3614	-189.5274	-1.2421	-1.9161	8.6179	-1.1256	-191.9091	8.068	0.4029	-187.1457
	3.52	7.8947	-0.357	-190.4191	-1.2334	-1.576	7.8997	-1.3096	-193.1346	7.8897	0.5955	-187.7035
	3.536	7.803	-0.5978	-191.689	-1.2265	-1.8598	8.0833	-1.5409	-194.4331	7.5226	0.3453	-188.9449
	3.552	8.2605	-1.1662	-192.7777	-1.1103	-1.8584	8.6289	-2.4114	-195.3953	7.8922	0.0789	-190.16
	3.568	8.0799	-1.6363	-192.8574	-1.1209	-1.8615	8.4431	-2.85	-195.4804	7.7168	-0.4225	-190.2344
	3.584	8.5376	-1.6707	-194.5419	-1.1611	-1.4808	8.4459	-2.6867	-196.8912	8.6293	-0.6546	-192.1926
	3.6	8.8039	-2.8098	-195.1582	-1.0888	-1.6891	8.9724	-4.2275	-197.8874	8.6353	-1.3921	-192.4289
	3.616	8.5278	-2.12	-196.2914	-1.0185	-2.1073	9.3372	-3.4813	-198.861	7.7183	-0.7588	-193.7218
	3.632	9.3169	-2.922	-197.1437	-1.0257	-1.6773	9.4791	-4.4391	-199.6596	9.1546	-1.4049	-194.6278
	3.648	8.5193	-3.2765	-197.7771	-0.9942	-1.8421	8.9555	-4.8452	-200.2807	8.083	-1.7078	-195.2735
	3.664	8.4462	-2.5346	-198.274	-0.8293	-1.6546	8.6273	-4.6909	-200.637	8.265	-0.3783	-195.911
	3.68	8.5315	-2.5675	-199.2517	-0.7641	-1.7687	8.9816	-4.8118	-201.4452	8.0814	-0.3233	-197.0581
	3.696	8.4195	-3.136	-200.3634	-0.8628	-1.9237	9.1287	-5.0616	-202.7605	7.7104	-1.2105	-197.9663
	3.712	8.6268	-4.7662	-200.6907	-1.1245	-1.885	8.9802	-5.8536	-203.0806	8.2733	-3.6787	-198.3007
	3.728	8.9674	-4.9225	-201.5054	-1.0277	-1.9296	9.4862	-6.3056	-203.9525	8.4487	-3.5393	-199.0583
	3.744	9.0458	-4.018	-202.5623	-1.0906	-1.5067	8.9512	-5.4929	-205.3995	9.1405	-2.5432	-199.725
	3.76	8.5216	-4.1427	-203.6775	-0.9445	-1.4241	8.2655	-5.8754	-206.0986	8.7777	-2.41	-201.2565
	3.776	9.0357	-4.919	-204.6298	-0.9431	-1.2864	8.5972	-6.4191	-206.7837	9.4742	-3.4188	-202.4759
	3.792	8.9696	-4.2222	-205.8893	-0.8901	-1.4667	8.7829	-6.0092	-208.108	9.1563	-2.4353	-203.6705
	3.808	9.0474	-4.8155	-206.6175	-0.9623	-1.4105	8.7751	-6.4999	-209.0667	9.3197	-3.131	-204.1683
	3.824	8.5234	-4.7721	-207.3649	-0.6526	-1.5354	8.4289	-7.4408	-209.406	8.6178	-2.1034	-205.3238

Man6	time	pos(x)	pos(y)	pos(z)	el	az	x1	y1	z1	x2	y2	z2
	3.84	8.5249	-4.696	-208.2735	-1.0293	1.5073	8.4289	-6.2063	-210.7895	8.621	-3.1858	-205.7574
	3.856	8.8623	-3.8758	-209.9028	-0.9027	1.4092	8.5814	-5.5988	-212.1148	9.1432	-2.1528	-207.6908
	3.872	8.5139	-3.9887	-210.4046	-0.8735	1.4107	8.2375	-5.7003	-212.4743	8.7903	-2.2771	-208.3348
	3.888	9.1273	-4.2722	-211.5775	-0.8247	1.2949	8.5702	-6.2402	-213.7903	9.6844	-2.3042	-209.3647
	3.904	9.1207	-4.7083	-212.6895	-0.9954	1.1832	8.57	-6.0574	-214.9363	9.6714	-3.3592	-210.4428
	3.92	9.6701	-4.5239	-213.6698	-0.962	1.2106	9.1151	-5.9976	-215.9289	10.2252	-3.0501	-211.4107
	3.936	9.3347	-3.847	-214.4947	-1.0217	0.9165	8.414	-5.0475	-216.9672	10.2554	-2.6465	-212.0222
	3.952	10.0449	-4.5346	-215.1528	-0.9171	0.866	8.9519	-5.8199	-217.3553	11.138	-3.2493	-212.9502
	3.968	9.6069	-3.95	-216.1182	-1.0159	0.7255	8.4346	-4.9896	-218.6461	10.7792	-2.9105	-213.5902
	3.984	9.5202	-4.0367	-217.0909	-1.0555	0.738	8.4401	-5.019	-219.669	10.6004	-3.0544	-214.5128
	4	8.7604	-3.9959	-217.8345	-1.004	0.6631	7.5158	-4.968	-220.3161	10.0051	-3.0238	-215.353
	4.016	8.8374	-4.1514	-218.7557	-1.0987	0.6923	7.8511	-4.9692	-221.2649	9.8236	-3.3336	-216.2464
	4.032	8.9362	-3.7071	-220.067	-1.126	0.4353	7.8665	-4.2046	-222.5417	10.0059	-3.2097	-217.5923
	4.048	8.7636	-3.3245	-221.0449	-1.1711	0.5935	7.8504	-3.9406	-223.6527	9.6769	-2.7084	-218.4371
	4.064	8.585	-2.8556	-222.1963	-1.3149	0.1374	7.8574	-2.9563	-225.0037	9.3126	-2.755	-219.389
	4.08	8.2638	-3.2279	-222.8105	-1.0969	0.1648	6.8344	-3.4656	-225.6358	9.6931	-2.9902	-219.9851
	4.096	8.2445	-2.6038	-223.6279	-1.189	0.0827	6.9847	-2.7082	-226.7762	9.5043	-2.4994	-220.4797
	4.112	7.7923	-2.2689	-224.7177	-1.1672	-0.2368	6.2593	-1.899	-228.4106	9.3253	-2.6388	-221.0248
	4.128	7.7053	-1.7293	-226.1302	-1.1602	-0.0461	6.2739	-1.6633	-229.4217	9.1368	-1.7953	-222.8388
	4.144	7.3156	-1.2625	-226.8801	-1.1097	-0.106	5.6969	-1.0903	-230.1571	8.9344	-1.4347	-223.6031
	4.16	7.1008	-0.5605	-227.8305	-1.2018	-0.2632	5.8198	-0.2154	-231.2609	8.3818	-0.9057	-224.4
	4.176	7.3135	-1.2542	-228.4784	-1.2694	-0.5173	6.389	-0.7281	-231.9004	8.238	-1.7802	-225.0565
	4.192	7.5726	-1.0778	-229.2953	-1.1758	-0.4291	6.3817	-0.5329	-232.4371	8.7635	-1.6227	-226.1534
	4.208	7.3459	-0.6809	-230.5381	-1.2884	-0.6691	6.6298	-0.1146	-233.6846	8.0621	-1.2473	-227.3916
	4.224	8.0935	0.0522	-231.1048	-1.2783	-1.5982	8.1204	1.0318	-234.3592	8.0667	-0.9274	-227.8504
	4.24	7.7496	-0.1713	-232.0702	-1.2114	-1.6026	7.7888	1.0566	-235.3399	7.7105	-1.3993	-228.8005
	4.256	7.7805	-0.3366	-233.1849	-1.2662	-1.6417	7.8544	0.7027	-236.4995	7.7066	-1.3759	-229.8703
	4.272	7.569	0.3389	-234.0551	-1.1864	-1.455	7.4239	1.5862	-237.1596	7.714	-0.9084	-230.9506
	4.288	7.6751	0.8153	-235.2194	-0.9687	-1.473	7.45	3.1093	-238.5733	7.9002	-1.4787	-231.8656
	4.304	7.9134	1.3903	-236.6292	-1.2096	-1.7163	8.0926	2.613	-239.9009	7.7342	0.1676	-233.3575
	4.32	8.3784	0.8467	-237.3603	-1.133	-1.5035	8.2684	2.4779	-240.8529	8.4883	-0.7844	-234.8676
	4.336	8.4746	1.0902	-238.0728	-1.1383	-1.5877	8.5021	2.7247	-241.6134	8.447	-0.5443	-236.5321
	4.352	8.486	1.6432	-239.058	-1.2425	-1.5687	8.4836	2.8305	-242.5439	8.4885	0.4559	-235.5722
	4.368	8.4092	2.1576	-240.0015	-1.1436	-1.4029	8.1591	3.6327	-243.2883	8.6593	0.6824	-236.7147
	4.384	9.1621	1.446	-240.8008	-1.0885	-1.4199	8.906	3.1306	-244.0554	9.4181	-0.2386	-237.5463
	4.4	9.4712	1.2784	-241.4959	-1.0566	-1.6853	9.7189	3.4329	-245.3347	9.2235	-0.876	-237.6571
	4.416	9.1025	1.6704	-242.5968	-1.1046	-1.5926	9.1402	3.3981	-246.0306	9.0648	-0.0572	-239.163
	4.432	9.0172	1.7669	-243.621	-1.0805	-1.7423	9.3444	3.6554	-247.2117	8.6901	-0.1216	-240.0302
	4.448	9.8799	1.9161	-244.8296	-1.0925	-1.4676	9.7252	3.4094	-247.7255	10.0346	0.4227	-241.9337
	4.464	9.3006	2.1541	-245.5643	-1.1684	-1.7376	9.5263	3.4946	-248.7583	9.0749	0.8136	-242.3703
	4.48	9.796	2.0099	-246.7561	-1.1181	-1.6691	9.9612	3.6853	-250.2174	9.6307	0.3346	-243.2949
	4.496	10.4401	2.2774	-247.7264	-1.0138	-2.3653	11.795	3.6078	-250.7756	9.0852	0.947	-244.6773
	4.512	11.6776	1.6657	-248.0457	-1.1437	-2.2313	12.5828	2.831	-251.2878	10.7724	0.5005	-244.8036
	4.528	11.6304	1.8686	-249.4059	-1.0069	-2.2026	12.8332	3.5121	-252.6264	10.4276	0.2251	-246.1854
	4.544	11.1453	2.4554	-250.1661	-1.0564	-2.0768	12.0436	4.0767	-253.446	10.247	0.8342	-246.8861
	4.56	11.8752	2.0453	-251.2024	-1.0294	-2.2798	12.9544	3.3034	-253.9588	10.7959	0.7871	-248.446
	4.576	12.7478	1.4615	-251.7114	-1.0302	-2.3499	14.0401	2.7701	-254.7757	11.4554	0.153	-248.6471
	4.592	12.4042	2.0959	-252.4787	-0.9725	-2.7291	14.0359	2.8099	-255.0915	10.7725	1.3819	-249.866
	4.608	13.3631	1.5387	-253.3551	-0.9566	-2.7021	15.1894	2.3974	-256.2168	11.5368	0.68	-250.4934
	4.624	13.4774	1.7151	-254.6209	-0.8841	-2.5047	15.4481	3.1729	-257.6108	11.5068	0.2574	-251.6311
	4.64	13.4996	1.8674	-255.5191	-0.9794	-2.6487	15.4487	2.9144	-258.8137	11.5504	0.8205	-252.2245
	4.656	13.5918	2.0236	-256.5256	-0.9191	-2.5352	15.439	3.3047	-259.4725	11.7445	0.7425	-253.5787
	4.672	14.2293	2.0436	-256.961	-1.0217	-2.4651	15.8113	3.3138	-260.2767	12.6473	0.7735	-253.6453
	4.688	14.1541	1.2462	-257.4518	-0.9713	-2.755	16.2703	2.1078	-260.7955	12.0379	0.3846	-254.1082
	4.704	14.5184	1.2833	-258.7992	-0.9631	-3.0145	16.6307	1.5532	-261.8606	12.4062	1.0133	-255.7377
	4.72	14.738	0.6842	-259.4092	-1.0413	-2.8923	16.5474	1.145	-262.5998	12.9286	0.2235	-256.2187
	4.736	14.4212	2.3251	-261.4394	-0.9639	-2.6901	16.533	3.3492	-264.8194	12.3094	1.3011	-258.0594
	4.752	15.1429	1.8604	-262.4886	-0.9573	-2.5907	16.854	2.9116	-265.3404	13.4319	0.8092	-259.6367
	4.768	15.3337	1.5321	-262.9028	-1.0129	-2.536	17.0586	2.7265	-266.2646	13.6087	0.3378	-259.5409
	4.784	15.1404	1.2951	-263.5593	-0.9003	-2.852	17.2505	1.9239	-266.3354	13.0303	0.6663	-260.7832
	4.8	15.798	1.5314	-264.5834	-0.9755	-2.9371	17.6827	1.9223	-267.4257	13.9132	1.1404	-261.7411
	4.816	16.2549	1.9913	-266.115	-0.9532	-3.1176	18.1375	2.0365	-268.7664	14.3723	1.9462	-263.4636
	4.832	16.4736	0.5859	-265.8616	-0.8982	-3.1382	18.9073	0.5942	-268.917	14.0399	0.5776	-262.8063
	4.848	16.1991	0.0771	-266.693	-0.8687	3.013	18.2074	-0.1826	-269.0871	14.1907	0.3368	-264.2989
	4.864	16.113	0.2223	-267.5067	-0.8863	3.0076	18.1715	-0.0553	-270.052	14.0545	0.4999	-264.9614
	4.88	17.5562	-0.2012	-268.3365	-0.9562	2.875	19.2591	-0.6663	-270.8373	15.8534	0.264	-265.8356

Man6											
time	pos(x)	pos(y)	pos(z)	el	az	x1	y1	z1	x2	y2	z2
4.896	18.1978	-0.3704	-268.7553	-0.7121	2.8515	20.7963	-1.146	-271.0958	15.5993	0.4052	-266.4147
4.912	18.7035	-1.0734	-268.6299	-1.0886	2.8905	20.1892	-1.4545	-271.5602	17.2178	-0.6924	-265.6997
4.928	18.6137	-0.8606	-270.2136	-0.9108	2.7229	20.349	-1.6329	-272.661	16.8784	-0.0884	-267.7662
4.944	19.2441	-1.1119	-271.1777	-0.9088	2.8457	21.1239	-1.6851	-273.6993	17.3643	-0.5388	-268.656
4.96	19.0876	-0.9191	-271.6048	-0.7411	2.6699	21.2534	-2.0239	-273.8298	16.9217	0.1857	-269.3798
4.976	19.7746	-1.8206	-272.2623	-0.8559	2.6846	21.8346	-2.8334	-274.9068	17.7146	-0.8078	-269.6178
4.992	20.5087	-1.3087	-273.1775	-0.8282	2.4412	22.0667	-2.622	-275.3975	18.9507	0.0047	-270.9576
5.008	20.491	-1.0564	-273.7902	-0.8514	2.4829	22.0052	-2.2284	-275.9761	18.9769	0.1155	-271.6043
5.024	21.4329	-1.5398	-274.7269	-0.9531	2.3381	22.6353	-2.7866	-277.1653	20.2304	-0.293	-272.2886
5.04	20.7788	-2.011	-275.5411	-0.9326	1.8274	21.2356	-3.7519	-277.9677	20.3219	-0.27	-273.1145
5.056	20.6084	-1.4574	-277.5527	-1.0405	1.5007	20.5105	-2.8521	-279.9374	20.7064	-0.0627	-275.1679
5.072	20.0589	-1.0877	-278.1406	-0.8245	1.9867	20.8638	-2.9103	-280.2952	19.2539	0.735	-275.986
5.088	19.8239	-0.5207	-279.5298	-1.0464	2.1057	20.5712	-1.7822	-282.0647	19.0765	0.7407	-276.9949

Manta											
time	pos(x)	pos(y)	pos(z)	el	az	x1	y1	z1	x2	y2	z2
0	0	0	0	-0.6684	-3.0155	1.5929	0.2019	-1.268	-1.5929	-0.2019	1.268
0.016	0.084	0.1087	-3.0973	-1.4453	-2.3993	0.2234	0.2365	-4.5962	-0.0554	-0.0192	-1.5984
0.032	-1.7063	0.2813	-6.0179	-1.4543	3.0117	-1.4451	0.2472	-8.2691	-1.9675	0.3154	-3.7666
0.048	-2.5538	0.617	-7.0493	-1.2358	-0.1615	-3.3344	0.7442	-9.3214	-1.7733	0.4898	-4.7771
0.064	-4.3533	0.9386	-8.1876	-0.9026	-0.1324	-6.1611	1.1794	-10.4981	-2.5455	0.6978	-5.8771
0.08	-5.0395	0.6974	-10.5098	-0.9263	-0.0726	-8.8815	0.8314	-12.9673	-3.1976	0.5634	-8.0523
0.096	-6.3425	0.6926	-12.188	-0.9868	-0.0365	-8.0424	0.7546	-14.7616	-4.6426	0.6306	-9.6144
0.112	-7.1894	1.0862	-13.2663	-0.58	-0.2241	-9.3567	1.5801	-14.7226	-5.0221	0.5923	-11.8101
0.128	-6.6427	0.7877	-15.7824	-0.6243	-0.092	-8.9427	1	-17.4465	-4.3426	0.5754	-14.1182
0.144	-6.6553	0.784	-17.5615	-0.5798	-0.1446	-8.9553	1.1189	-19.0836	-4.3552	0.449	-16.0394
0.16	-5.2001	0.0218	-20.0932	-0.8192	-0.1204	-6.9923	0.2387	-22.0249	-3.4078	-0.195	-18.1615
0.176	-5.7351	-0.4511	-21.7128	-0.5845	-0.0508	-8.1673	-0.3275	-23.3242	-3.3029	-0.5746	-20.1014
0.192	-6.1018	-0.7163	-23.4444	-0.787	-0.0115	-8.461	-0.6891	-25.8115	-3.7425	-0.7434	-21.0774
0.208	-5.8517	-0.6267	-24.4698	-0.8624	-0.0424	-7.7836	-0.5448	-26.7267	-3.9198	-0.7086	-22.2129
0.224	-6.0672	-0.8606	-25.5075	-0.8765	-0.1134	-7.9727	-0.6437	-27.811	-4.1617	-1.0776	-23.2041
0.24	-5.7498	-1.0723	-26.4114	-0.9703	-0.1997	-7.4328	-0.7316	-28.9186	-4.0668	-1.4129	-23.9043
0.256	-5.8457	-1.0649	-26.7469	-0.9689	-0.1756	-7.5597	-0.7607	-29.281	-4.1316	-1.3691	-24.2128
0.272	-5.4996	-1.0562	-27.4104	-0.9806	-0.1393	-6.964	-0.8509	-29.6181	-4.0352	-1.2615	-25.2027
0.288	-5.2133	-1.0527	-28.3824	-0.961	-0.1877	-7.0187	-0.7097	-31.0128	-3.408	-1.3956	-25.752
0.304	-5.5183	-1.1144	-29.7387	-0.967	-0.124	-7.312	-0.8909	-32.3593	-3.7246	-1.3379	-27.1181
0.32	-5.9801	-0.3959	-29.6963	-0.9874	-0.1687	-7.4591	-0.144	-31.9692	-4.5012	-0.6478	-27.4235
0.336	-4.6358	-0.6545	-30.6379	-1.1775	-0.2311	-5.5386	-0.4421	-32.8735	-3.733	-0.8668	-28.4024
0.352	-4.1932	-0.6574	-31.562	-0.9199	-0.0522	-5.773	-0.5749	-33.639	-2.6135	-0.7399	-29.4851
0.368	-4.5118	-1.2005	-31.4165	-1.4769	-0.6699	-4.7038	-1.0485	-34.0175	-4.3199	-1.3526	-28.8155
0.384	-3.4555	-0.9481	-32.3775	-1.5399	2.8041	-3.3762	-0.9759	-35.1002	-3.5348	-0.9203	-29.6549
0.4	-3.391	-0.8925	-32.5873	-1.4438	-2.7286	-3.0872	-0.7594	-35.1852	-3.6947	-1.0256	-29.9894
0.416	-3.4576	-0.9104	-33.2207	-1.4485	-3.1236	-3.1303	-0.9045	-35.8841	-3.7849	-0.9163	-30.5574
0.432	-3.1833	-1.2122	-34.3623	-1.3134	-2.9801	-2.458	-1.094	-37.154	-3.9086	-1.3303	-31.5706
0.448	-3.2915	-0.8915	-34.2549	-1.3659	-3.0698	-2.717	-0.8502	-37.0265	-3.866	-0.9329	-31.4833
0.464	-3.34	-0.9149	-35.2947	-1.3224	-2.7073	-2.7277	-0.6309	-37.9556	-3.9524	-1.199	-32.6337
0.48	-2.6584	-0.9953	-35.8726	-1.3153	-3.0818	-1.9352	-0.952	-38.6457	-3.3816	-1.0386	-33.0995
0.496	-2.3853	-1.1045	-36.6042	-1.2316	-2.9937	-1.6005	-0.9876	-38.853	-3.1701	-1.2214	-34.3553
0.512	-2.2439	-1.0931	-37.3546	-1.2794	3.0984	-1.4311	-1.1283	-40.0668	-3.0567	-1.058	-34.6425
0.528	-2.0345	-2.1337	-39.0183	-1.2774	2.7112	-1.1117	-2.5573	-42.3796	-2.9574	-1.71	-35.6569
0.544	-2.2918	-2.7602	-40.2138	-1.3298	3.078	-1.5579	-2.807	-43.2054	-3.0257	-2.7135	-37.2222
0.56	-1.948	-2.4092	-40.5421	-1.3319	3.0384	-1.2165	-2.4849	-43.5619	-2.6796	-2.3334	-37.5224
0.576	-1.3265	-2.5036	-41.3404	-1.3214	2.9708	-0.567	-2.6345	-44.3662	-2.0859	-2.3726	-38.3147
0.592	-0.8681	-2.2703	-41.8411	-1.3661	2.9306	-0.2531	-2.4021	-44.8703	-1.4832	-2.1386	-38.8119
0.608	-0.7665	-2.4742	-43.0109	-1.3062	2.8452	0.064	-2.7278	-46.2159	-1.597	-2.2206	-39.8059
0.624	-0.8085	-2.8837	-43.315	-1.3925	2.9236	-0.2954	-2.9973	-46.2317	-1.3217	-2.77	-40.3982
0.64	-0.8205	-2.6911	-43.8775	-1.2831	2.9229	0.1298	-2.9023	-47.1671	-1.7707	-2.4798	-40.5878
0.656	-0.3086	-2.6643	-44.8319	-1.4269	-2.6798	0.0288	-2.4964	-47.4325	-0.6459	-2.8322	-42.2313
0.672	-0.2678	-2.4573	-45.0196	-1.3888	3.0349	0.2733	-2.5152	-47.9767	-0.8088	-2.3994	-42.0626
0.688	0.8943	-2.6886	-45.9029	-1.495	2.85	1.1026	-2.7511	-48.7646	0.6861	-2.6261	-43.0412
0.704	0.4817	-3.4813	-47.2793	-1.2851	3.0278	1.3178	-3.5769	-50.1442	-0.3544	-3.3858	-44.4143
0.72	-0.1461	-3.6701	-48.5577	-1.3384	3.1181	0.5217	-3.6858	-51.3796	-0.8139	-3.6544	-45.7358
0.736	0.1878	-3.6422	-48.7801	-1.4163	3.0258	0.6279	-3.6934	-51.6254	-0.2522	-3.591	-45.9348
0.752	-0.0879	-3.8245	-49.6101	-1.4331	2.8609	0.3151	-3.9407	-52.6366	-0.4909	-3.7083	-46.5836
0.768	0.4383	-3.4446	-49.7929	-1.3887	2.4544	0.8895	-3.8149	-52.9625	-0.013	-3.0743	-46.6234

Man7	time	pos(x)	pos(y)	pos(z)	el	az	x1	y1	z1	x2	y2	z2
	0.784	0.8705	-3.6492	-50.6365	-1.4953	2.744	1.0824	-3.7382	-53.676	0.6587	-3.5603	-47.597
	0.8	1.0759	-4.0343	-51.5999	-1.3857	2.5913	1.5563	-4.329	-54.6099	0.5954	-3.7396	-48.5899
	0.816	0.9015	-4.771	-52.6931	-1.4178	2.8593	1.3409	-4.8985	-55.6609	0.4621	-4.6436	-49.7253
	0.832	0.8141	-5.092	-53.6446	-1.2526	2.534	1.7011	-5.7087	-56.9249	-0.0728	-4.4752	-50.3644
	0.848	0.3467	-4.8134	-54.2289	-1.2661	2.5672	1.0606	-5.2754	-56.9326	-0.3672	-4.3515	-51.5253
	0.864	0.3896	-4.951	-54.9428	-1.2953	2.4824	1.0486	-5.4617	-57.8921	-0.2695	-4.4404	-51.9934
	0.88	-0.1839	-5.0593	-55.6704	-1.3575	2.6316	0.3766	-5.3728	-58.6354	-0.7444	-4.7458	-52.7054
	0.896	-0.0237	-4.5445	-55.246	-1.2338	2.8186	0.9933	-4.8849	-58.3065	-1.0406	-4.2041	-52.1855
	0.912	-0.0297	-4.9629	-56.9387	-1.312	2.4625	0.5751	-5.451	-59.8741	-0.6344	-4.4747	-54.0033
	0.928	-0.0635	-5.0931	-57.4602	-1.2892	2.5173	0.6033	-5.5735	-60.3016	-0.7303	-4.6126	-54.6187
	0.944	0.4591	-5.2339	-58.3099	-1.2414	2.5864	1.3461	-5.784	-61.3627	-0.4279	-4.6838	-55.2571
	0.96	-0.1225	-5.3236	-59.056	-1.1885	2.3157	0.6915	-6.2064	-62.0422	-0.9365	-4.4408	-56.0698
	0.976	0.2323	-5.7179	-59.9328	-1.2527	2.2919	0.8737	-6.4475	-62.8833	-0.409	-4.9882	-56.9823
	0.992	0.081	-5.349	-59.9272	-1.2736	2.1212	0.5763	-6.1561	-63.019	-0.4143	-5.542	-56.8355
	1.008	0.3118	-6.8335	-62.8872	-1.2697	2.1772	0.7777	-7.5052	-65.52	-0.1541	-6.1617	-60.2543
	1.024	-0.1371	-6.5615	-62.7531	-1.2883	2.0849	0.2214	-7.1964	-65.2652	-0.4957	-5.9266	-60.2409
	1.04	0.0717	-7.0704	-63.7447	-1.2893	2.117	0.4716	-7.7282	-66.4065	-0.3281	-6.4126	-61.083
	1.056	-0.1725	-6.541	-64.4999	-1.2315	2.3364	0.4459	-7.1845	-67.0288	-0.791	-5.8976	-61.9711
	1.072	-0.1643	-6.6444	-65.0401	-1.201	2.0391	0.2574	-7.4781	-67.4507	-0.586	-5.8107	-62.6295
	1.088	0.1246	-7.3423	-66.4432	-1.1394	2.2463	0.7969	-8.1813	-68.7792	-0.5478	-6.5033	-64.1072
	1.104	-0.4125	-7.1087	-66.6954	-1.1707	2.2771	0.1445	-7.7617	-68.7248	-0.9696	-6.4557	-64.6661
	1.12	-0.0791	-7.2331	-67.5385	-1.1488	2.4127	0.6204	-7.8577	-69.6273	-0.7786	-6.6085	-65.4497
	1.136	-0.1693	-7.8118	-69.1811	-1.2384	2.1442	0.2153	-8.4072	-71.2345	-0.5538	-7.2163	-67.1278
	1.152	0.2614	-7.7558	-69.302	-1.238	1.4624	0.1817	-8.4885	-71.4345	0.3411	-7.0232	-67.1696
	1.168	-0.0279	-8.2061	-70.2967	-1.2846	1.6821	0.0504	-8.9071	-72.6941	-0.1063	-7.5051	-67.8992
	1.184	-0.0709	-8.4194	-71.813	-1.1715	1.4949	-0.1378	-9.2979	-73.9011	-0.0041	-7.5409	-69.7249
	1.2	-0.0074	-8.3887	-72.2871	-1.1546	1.8325	0.2533	-9.3622	-74.5672	-0.2681	-7.4152	-70.0071
	1.216	-0.3522	-7.8993	-72.2933	-1.1047	1.59	-0.3329	-8.9028	-74.2886	-0.3715	-6.8958	-70.298
	1.232	-0.645	-8.3623	-73.2801	-1.0282	1.667	-0.5332	-9.5209	-75.2108	-0.7568	-7.2036	-71.3494
	1.248	-0.7256	-8.5145	-74.3172	-1.0677	1.7199	-0.5525	-9.6674	-76.4358	-0.8988	-7.3615	-72.1986
	1.264	-0.8511	-8.702	-75.0601	-1.0954	1.3046	-1.1322	-9.7327	-77.1353	-0.5701	-7.6713	-72.9849
	1.28	-0.8814	-9.1412	-76.17	-1.0441	1.2985	-1.2244	-10.3694	-78.363	-0.5385	-7.913	-73.9769
	1.296	-0.9367	-9.1317	-76.3807	-1.2166	1.3745	-1.1028	-9.9667	-78.6832	-0.7706	-8.2967	-74.0782
	1.312	-0.7889	-9.3853	-77.3512	-1.1748	1.2843	-1.0942	-10.4216	-79.935	-0.4836	-8.349	-74.7673
	1.328	-0.6834	-9.8255	-78.2091	-1.1758	0.9456	-1.2285	-10.5808	-80.4432	-0.1382	-9.0703	-75.975
	1.344	-0.7225	-9.9107	-78.7644	-1.119	1.2252	-1.1652	-11.1401	-81.4572	-0.2799	-8.6813	-76.0716
	1.36	-0.7471	-9.6368	-79.0821	-1.2033	1.2034	-1.1265	-10.6226	-81.8258	-0.3676	-8.651	-76.3384
	1.376	-1.1809	-9.8422	-80.0896	-1.1243	0.8043	-2.1069	-10.8038	-82.8779	-0.2549	-8.8806	-77.3013
	1.392	-1.3616	-9.8817	-81.0395	-1.1178	0.8235	-2.2473	-10.8376	-83.7169	-0.476	-8.9258	-78.3622
	1.408	-1.3821	-9.9533	-81.7253	-1.1232	1.1509	-1.9049	-11.1243	-84.3962	-0.8593	-8.7822	-79.0543
	1.424	-1.6789	-10.4037	-83.168	-1.0896	0.7913	-2.6276	-11.3637	-85.7528	-0.7302	-9.4436	-80.5832
	1.44	-2.0605	-10.2695	-83.8644	-1.0823	0.6972	-3.1044	-11.1438	-86.4266	-1.0166	-9.3952	-81.3022
	1.456	-2.0761	-10.6217	-84.3779	-1.021	0.6655	-3.321	-11.5989	-86.9604	-0.8312	-9.6445	-81.7953
	1.472	-2.1582	-10.8151	-85.2584	-1.0435	0.7314	-3.3802	-11.9118	-88.0783	-0.9362	-9.7185	-82.4384
	1.488	-2.6165	-10.9115	-86.1978	-1.0529	0.6739	-3.8713	-11.9136	-89.0164	-1.3616	-9.9093	-83.3792
	1.504	-2.617	-11.1102	-86.5895	-1.0995	0.8872	-3.5393	-12.2423	-89.455	-1.6948	-9.9781	-83.7241
	1.52	-3.1269	-11.0776	-87.2735	-1.1265	0.4112	-4.3736	-11.6213	-90.1303	-1.8802	-10.5339	-84.4167
	1.536	-3.6313	-10.9409	-87.4997	-1.2627	0.5108	-4.4785	-11.4157	-90.5513	-2.784	-10.4661	-84.4482
	1.552	-3.6696	-10.8798	-88.1729	-1.0294	0.4363	-5.2306	-11.6076	-91.0371	-2.1087	-10.152	-85.3088
	1.568	-4.0042	-11.0031	-89.2385	-0.9926	0.4739	-5.523	-11.7822	-91.8543	-2.4855	-10.2241	-86.6227
	1.584	-3.7891	-10.8362	-89.8556	-1.1481	0.4893	-4.9429	-11.4506	-92.7621	-2.6353	-10.2218	-86.9492
	1.6	-4.9607	-11.0742	-90.5489	-1.1588	0.7057	-5.8881	-11.8645	-93.3369	-4.0333	-10.284	-87.7609
	1.616	-5.0531	-10.7008	-90.846	-1.0864	0.3337	-6.4926	-11.1998	-93.7411	-3.6136	-10.2017	-87.9509
	1.632	-4.9204	-11.0953	-91.6175	-1.0895	0.1124	-6.3058	-11.2516	-94.2868	-3.5349	-10.939	-88.9483
	1.648	-5.731	-10.6891	-91.869	-1.0367	0.1703	-7.1217	-10.9282	-94.2551	-4.3403	-10.4499	-89.483
	1.664	-6.2153	-10.8384	-92.1277	-0.9979	0.0793	-7.702	-10.9566	-94.4399	-4.7285	-10.7202	-89.8156
	1.68	-5.6654	-10.7213	-93.419	-1.0431	0.0564	-7.0941	-10.802	-95.874	-4.2367	-10.6406	-90.9639
	1.696	-6.188	-10.7399	-93.7105	-1.0664	0.1407	-7.6121	-10.9416	-96.3163	-4.7639	-10.5382	-91.1047
	1.712	-6.1642	-10.9657	-94.7403	-0.9334	-0.0062	-7.934	-10.9546	-97.1303	-4.3943	-10.9768	-92.3502
	1.728	-6.498	-11.0765	-95.6347	-1.0406	0.0664	-8.0622	-11.1805	-98.3094	-4.9338	-10.9725	-92.96
	1.744	-6.3256	-10.9657	-96.0632	-0.967	-0.1826	-8.1239	-10.6336	-98.7146	-4.5274	-11.2978	-93.4119
	1.76	-6.1225	-11.2797	-96.8617	-0.9566	-0.0734	-7.9479	-11.1455	-99.4574	-4.2972	-11.414	-94.2659
	1.776	-6.5701	-11.314	-97.5332	-0.8907	-0.1741	-8.1617	-11.034	-99.5314	-4.9784	-11.594	-95.535
	1.792	-6.67	-11.3291	-98.2229	-0.8587	-0.153	-8.483	-11.0495	-100.348	-4.8571	-11.6088	-96.0977
	1.808	-6.8183	-10.8461	-99.158	-0.8759	-0.3106	-8.6852	-10.2469	-101.5102	-4.9514	-11.4453	-96.8059
	1.824	-6.7919	-10.8872	-99.3964	-0.787	-0.4069	-8.7607	-10.0387	-101.547	-4.8232	-11.7357	-97.2458

Man7

time	pos(x)	pos(y)	pos(z)	el	az	x1	y1	z1	x2	y2	z2
1.84	-6.7727	-10.8036	-100.2107	-0.7949	-0.4374	-8.7415	-9.8831	-102.4258	-4.8039	-11.7241	-97.9956
1.856	-6.9145	-10.7024	-101.0032	-0.8434	-0.5826	-8.4289	-9.7045	-103.0403	-5.4001	-11.7003	-98.966
1.872	-6.8244	-10.6236	-101.4897	-0.6202	-0.5868	-8.8962	-9.2461	-103.2668	-4.7526	-12.0011	-99.7127
1.888	-6.1003	-10.5505	-102.5951	-0.7844	-0.6435	-7.6458	-9.3914	-104.5233	-4.5548	-11.7097	-100.6669
1.904	-6.4307	-10.7575	-103.2829	-0.7187	-0.7316	-7.7677	-9.557	-104.8547	-5.0937	-11.958	-101.7111
1.92	-5.9486	-11.0828	-104.2582	-0.888	-0.7569	-7.1081	-9.9877	-106.219	-4.7892	-12.1779	-102.2974
1.936	-6.3405	-10.8503	-105.1265	-0.7356	-0.6607	-7.94	-9.6071	-106.9601	-4.741	-12.0935	-103.2929
1.952	-5.9401	-11.2018	-105.6957	-0.7016	-0.8314	-7.3517	-9.6538	-107.4659	-4.5285	-12.7498	-103.9254
1.968	-5.7785	-11.0409	-106.3499	-0.7565	-0.7717	-7.1663	-9.6904	-108.1775	-4.3906	-12.3913	-104.5223
1.984	-6.1794	-11.1525	-107.2897	-0.8262	-1.052	-6.9627	-9.7806	-109.0038	-5.396	-12.5244	-105.5755
2	-6.0014	-11.4003	-107.9824	-0.8132	-0.8316	-7.186	-10.101	-109.8415	-4.8167	-12.6997	-106.1234
2.016	-5.4738	-11.2896	-108.8689	-0.7109	-0.9029	-6.6287	-9.8255	-110.4746	-4.3189	-12.7536	-107.2633
2.032	-5.6768	-11.0044	-109.8632	-0.7829	-0.9723	-6.73	-9.4603	-111.7229	-4.6237	-12.5486	-108.0035
2.048	-4.8054	-11.3073	-110.53	-0.8385	-1.0399	-5.5944	-9.9633	-112.2635	-4.0164	-12.6513	-108.7964
2.064	-4.7101	-11.8416	-111.701	-0.7935	-1.1675	-5.375	-10.2834	-113.4228	-4.0452	-13.3998	-109.9792
2.08	-3.9025	-12.1476	-112.4778	-0.7913	-1.1839	-4.5354	-10.5943	-114.1748	-3.2696	-13.7009	-110.7807
2.096	-4.4186	-11.7821	-112.986	-0.9842	-1.4464	-4.569	-10.5796	-114.8093	-4.2682	-12.9847	-111.1628
2.112	-3.9307	-11.5776	-113.417	-1.0026	-1.7009	-3.7752	-10.3898	-115.2934	-4.0861	-12.7654	-111.5406
2.128	-3.329	-12.3364	-114.4648	-0.9585	-1.7886	-3.0782	-11.2033	-116.1173	-3.5798	-13.4695	-112.8123
2.144	-3.2038	-12.0376	-115.1817	-0.9497	-1.8787	-2.8155	-10.8164	-116.9724	-3.5922	-13.2588	-113.391
2.16	-2.921	-12.5428	-116.0192	-0.8404	-1.7432	-2.6494	-10.9827	-117.7873	-3.1927	-14.1029	-114.2512
2.176	-2.5871	-12.971	-116.6224	-0.9382	-2.0596	-1.9645	-11.8002	-118.4311	-3.2097	-14.1418	-114.8137
2.192	-2.3535	-12.4809	-117.9017	-0.9868	-2.1361	-1.6383	-11.3535	-119.9218	-3.0688	-13.6083	-115.8817
2.208	-1.7527	-12.7419	-118.6849	-0.8982	-2.0856	-1.0222	-11.4505	-120.5476	-2.4833	-14.0333	-116.8221
2.224	-1.3338	-13.1724	-119.4728	-0.8177	-2.2174	-0.2422	-11.7264	-121.4056	-2.4254	-14.6184	-117.5399
2.24	-1.51	-13.26	-120.2492	-0.9325	-2.333	-0.4764	-12.1772	-122.267	-2.5436	-14.3428	-118.2315
2.256	-0.9709	-14.0559	-121.4801	-0.556	-1.9716	-0.0064	-11.7795	-123.0163	-1.9355	-16.3323	-119.9439
2.272	-0.7031	-14.6201	-122.1794	-0.8172	-2.3838	0.527	-13.4562	-123.9844	-1.9333	-15.7841	-120.3744
2.288	-0.9311	-14.5386	-122.759	-0.9287	-2.4717	0.2687	-13.5883	-124.8056	-2.1308	-15.4889	-120.7125
2.304	-0.51	-14.9372	-123.6234	-0.7539	-2.3947	0.745	-13.7752	-125.2291	-1.765	-16.0992	-122.0176
2.32	-0.4751	-15.2265	-125.086	-0.8185	-2.82	1.0919	-14.7044	-126.8509	-2.0422	-15.7487	-123.3211
2.336	0.0508	-15.5042	-125.899	-0.8949	-2.8358	1.3261	-15.1015	-127.5668	-1.2245	-15.9069	-124.2313
2.352	0.5669	-15.9412	-126.5954	-0.8517	-2.9999	2.0674	-15.7272	-128.3266	-0.9336	-16.1552	-124.8642
2.368	0.9485	-16.5567	-127.6905	-0.7201	-2.7209	2.3877	-15.9128	-129.0735	-0.4907	-17.2006	-126.3074
2.384	0.7805	-16.7677	-127.8609	-0.719	-2.8488	2.3907	-16.2823	-129.333	-0.8297	-17.2531	-126.3889
2.4	1.1066	-16.9649	-128.7471	-0.8989	-3.0019	2.2869	-16.7989	-130.2457	-0.0738	-17.1308	-127.2485
2.416	0.9854	-17.8029	-130.1991	-0.8092	-2.8434	2.2086	-17.4269	-131.5412	-0.2377	-18.1789	-128.857
2.432	1.3703	-18.2147	-130.9062	-0.7423	-2.9262	2.7823	-17.9058	-132.2322	-0.0417	-18.5236	-129.5802
2.448	1.8312	-18.6687	-131.773	-0.8377	3.0142	3.1468	-18.8372	-133.2457	0.5157	-18.5002	-130.3003
2.464	1.6219	-18.6037	-132.4328	-0.8502	2.8386	2.8859	-18.9988	-133.9408	0.3579	-18.2086	-130.9248
2.48	1.4848	-19.2053	-133.2722	-0.8378	2.9853	2.7876	-19.4106	-134.7372	0.182	-19.0001	-131.8073
2.496	1.514	-19.4982	-134.2889	-0.7518	3.0573	3.0743	-19.6301	-135.7527	-0.0462	-19.3664	-132.8251
2.512	1.5173	-20.0256	-134.9798	-0.7276	3.0029	3.2112	-20.2619	-136.5029	-0.1765	-19.7892	-133.4567
2.528	1.6292	-20.5676	-135.8652	-0.7478	2.9301	3.2449	-20.9145	-137.3978	0.0135	-20.2207	-134.3326
2.544	1.5385	-20.8527	-136.8613	-0.8447	2.9441	3.0319	-21.1515	-138.5764	0.0451	-20.554	-135.1462
2.56	1.7771	-21.1703	-137.8518	-0.8029	2.7487	3.0728	-21.7073	-139.3044	0.4814	-20.6333	-136.3992
2.576	1.9006	-21.0239	-138.3829	-0.8268	2.9163	3.4428	-21.3773	-140.1019	0.3584	-20.6704	-136.6639
2.592	1.9939	-21.1238	-138.1263	-1.0549	2.546	3.3773	-22.0613	-141.0728	0.6105	-20.1863	-135.1798
2.608	1.7511	-21.635	-138.6235	-1.0772	2.5202	2.9873	-22.5201	-141.4491	0.515	-20.7498	-135.7978
2.624	1.5037	-22.1682	-139.7992	-1.1415	2.5049	2.5094	-22.9118	-142.5314	0.498	-21.4245	-137.0671
2.64	1.4323	-21.8937	-140.6488	-1.097	2.2905	2.3995	-22.9973	-143.5105	0.465	-20.7902	-137.7872
2.656	1.0787	-22.1763	-141.429	-1.1689	2.5218	2.0052	-22.8374	-144.1066	0.1522	-21.5152	-138.7514
2.672	0.964	-22.3149	-142.0635	-1.0746	2.1651	1.8202	-23.5818	-144.8878	0.1078	-21.048	-139.2392
2.688	0.5728	-22.985	-142.8188	-0.9534	2.2028	1.6466	-24.4514	-145.3786	-0.5009	-21.5186	-140.259
2.704	1.1511	-23.1557	-143.8056	-1.0504	2.2422	2.1283	-24.3858	-146.5465	0.1739	-21.9257	-141.0646
2.72	1.1667	-23.8382	-144.8246	-0.8842	2.1322	2.2401	-25.545	-147.2847	0.0932	-22.1313	-142.3645
2.736	0.7631	-23.6233	-145.041	-0.932	2.1763	1.8344	-25.1709	-147.5752	-0.3083	-22.0757	-142.5067
2.752	1.0943	-24.3485	-145.757	-1.0288	2.1495	2.0174	-25.7614	-148.5601	0.1713	-22.9355	-142.9539
2.768	1.2522	-25.082	-146.4167	-0.9971	1.8485	1.7579	-26.8556	-149.2706	0.7466	-23.3083	-143.5627
2.784	1.1003	-24.7897	-147.2227	-1.0866	1.7202	1.3127	-26.2012	-149.9364	0.8878	-23.3782	-144.5091
2.8	0.845	-25.3151	-148.0213	-1.0331	1.6728	0.9799	-26.6321	-150.2416	0.7102	-23.9981	-145.801
2.816	0.6723	-25.3114	-148.5469	-0.9896	1.6396	0.7922	-27.0535	-151.2054	0.5523	-23.5694	-145.8885
2.832	0.7362	-26.1495	-149.1883	-1.0234	1.8029	1.1286	-27.8095	-151.9866	0.3438	-24.4894	-146.39
2.848	0.7036	-26.0243	-150.3612	-0.9616	1.7533	1.0374	-27.8333	-152.9973	0.3697	-24.2153	-147.725
2.864	0.8889	-26.6323	-150.9022	-0.9364	1.7566	1.2236	-28.4121	-153.3629	0.5543	-24.8526	-148.4415
2.88	0.5071	-26.4337	-151.5721	-0.9407	1.8085	0.997	-28.4551	-154.4239	0.0173	-24.4123	-148.7203

Man7	time	pos(x)	pos(y)	pos(z)	el	az	x1	y1	z1	x2	y2	z2
	2.896	0.5649	-26.6905	-152.4333	-0.8515	1.6879	0.826	-28.9101	-154.9849	0.3039	-24.471	-149.8817
	2.912	0.2292	-26.0887	-152.5906	-0.942	1.699	0.4957	-28.1565	-155.4574	-0.0373	-24.0208	-149.7238
	2.928	0.1386	-26.6839	-153.5774	-1.0212	1.6691	0.3155	-28.4779	-156.5204	-0.0382	-24.8899	-150.6345
	2.944	0.3004	-26.8469	-153.9902	-0.9706	1.6624	0.4737	-28.7332	-156.7577	0.1272	-24.9605	-151.2227
	2.96	0.1382	-26.9417	-154.621	-1.0017	1.483	-0.0137	-28.6679	-157.3302	0.2902	-25.2155	-151.9118
	2.976	-0.0258	-27.1603	-155.5689	-0.9155	1.5304	-0.0992	-28.9759	-157.933	0.0476	-25.3446	-153.2047
	2.992	-0.1684	-28.1533	-156.6256	-0.8357	1.6844	0.0727	-30.266	-158.9775	-0.4094	-26.0407	-154.2737
	3.008	0.095	-28.0557	-157.4804	-0.8514	1.5532	0.0599	-30.0479	-159.7548	0.1301	-26.0635	-155.206
	3.024	0.0235	-28.3346	-158.5601	-0.8126	1.5717	0.0255	-30.542	-160.891	0.0216	-26.1272	-156.2293
	3.04	0.0081	-28.5759	-159.1618	-0.8448	1.4904	-0.1684	-30.7661	-161.6371	0.1845	-26.3856	-156.6864
	3.056	-0.1308	-28.8731	-160.1348	-0.9596	1.3865	-0.4298	-30.477	-162.4634	0.1682	-27.2693	-157.8063
	3.072	-0.0188	-29.1691	-160.5791	-0.9451	1.0752	-0.8643	-30.7329	-163.0396	0.8267	-27.6053	-158.1187
	3.088	-0.1815	-29.3495	-161.1056	-0.9622	1.2846	-0.6139	-30.8188	-163.3036	0.2508	-27.8802	-158.9075
	3.104	-0.0282	-29.8087	-162.042	-0.8872	1.2741	-0.9238	-31.7569	-164.5426	0.2674	-28.8605	-159.5414
	3.12	0.1964	-30.1647	-162.9279	-0.9161	0.9574	-0.7321	-31.4835	-165.0289	1.1248	-28.8459	-160.8268
	3.136	0.2687	-28.8445	-163.1899	-0.8374	0.9858	-0.7752	-30.4205	-165.2879	1.3125	-27.2684	-161.0919
	3.152	0.0675	-29.093	-164.2738	-0.9632	1.0306	-0.8429	-30.6112	-166.8199	0.978	-27.5747	-161.7278
	3.168	-0.6353	-29.1707	-164.6837	-1.0475	0.9492	-1.4201	-30.2663	-167.0194	0.1494	-28.0751	-162.348
	3.184	-0.8843	-28.6654	-165.2975	-1.0022	1.2537	-1.3303	-30.0245	-167.536	-0.4382	-27.3063	-163.0591
	3.2	-0.7102	-29.0584	-166.1379	-1.1079	1.0242	-1.3227	-30.0651	-168.4991	-0.0976	-28.0517	-163.7767
	3.216	-1.1869	-29.0251	-167.1336	-1.231	1.068	-1.5968	-29.7704	-169.5399	-0.777	-28.2797	-164.7272
	3.232	-1.4953	-28.6248	-167.4154	-1.223	1.6747	-1.4083	-29.4589	-169.7285	-1.5823	-27.7907	-165.1023
	3.248	-1.1979	-28.8957	-168.6212	-1.3396	0.9652	-1.5314	-29.3773	-171.1097	-0.8644	-28.4141	-166.1327
	3.264	-1.365	-28.4786	-169.133	-1.3254	0.7771	-1.8272	-28.9331	-171.722	-0.9028	-28.024	-166.5441
	3.28	-1.1886	-28.4984	-169.9204	-1.3352	0.1045	-1.7743	-28.5599	-172.3736	-0.6028	-28.437	-167.4672
	3.296	-1.0112	-28.8835	-170.6713	-1.2171	0.2004	-1.9357	-29.0713	-173.2262	-0.0867	-28.6957	-168.1165
	3.312	-1.4761	-28.2266	-171.1261	-1.2007	-0.1003	-2.4568	-28.1279	-173.6664	-0.4955	-28.3252	-168.5859
	3.328	-1.5772	-27.9666	-171.8918	-1.2318	-0.0386	-2.4968	-27.931	-174.5015	-0.6575	-28.0021	-169.2821
	3.344	-1.9567	-28.2672	-172.151	-1.1415	-0.0906	-2.946	-28.1773	-174.321	-0.9673	-28.357	-169.981
	3.36	-1.7061	-28.6845	-172.781	-1.3585	-0.3552	-2.1555	-28.5178	-175.0044	-1.2568	-28.8511	-170.5576
	3.376	-1.7025	-28.6734	-173.7254	-1.3824	-1.0158	-1.9485	-28.2768	-176.1737	-1.4566	-29.0701	-171.2772
	3.392	-1.7875	-28.1909	-174.0511	-1.2945	-0.7873	-2.2948	-27.6817	-176.5859	-1.2803	-28.7001	-171.5163
	3.408	-1.9275	-28.0861	-175.3743	-1.1265	-0.5591	-2.9549	-27.4432	-177.92	-0.9002	-28.7289	-172.8287
	3.424	-1.4359	-28.1222	-175.8322	-1.0079	-0.7835	-2.5232	-27.0391	-178.2643	-0.3486	-29.2052	-173.4
	3.44	-1.8394	-27.5134	-176.4602	-1.0432	-0.8566	-2.7512	-26.4617	-178.849	-0.9277	-28.5651	-174.0714
	3.456	-1.6991	-28.0032	-176.9342	-1.0373	-0.9243	-2.5575	-26.8659	-179.3467	-0.8408	-29.1405	-174.5216
	3.472	-1.6358	-27.6765	-177.9082	-0.9491	-0.9288	-2.6586	-26.3085	-180.2924	-0.6129	-29.0444	-175.5241
	3.488	-1.6923	-27.3114	-177.9746	-0.9098	-1.0258	-2.6213	-25.7789	-180.2788	-0.7633	-28.8439	-175.6704
	3.504	-1.7655	-26.961	-178.9159	-0.7612	-1.0318	-3.0474	-24.8176	-181.2952	-0.4836	-29.1044	-176.5365
	3.52	-1.9655	-26.4917	-179.4762	-0.7874	-1.0136	-3.2454	-24.4371	-181.9065	-0.6855	-28.5462	-177.046
	3.536	-2.1298	-26.2979	-180.5527	-0.7494	-1.0405	-3.4517	-24.0437	-182.9844	-0.808	-28.5521	-178.121
	3.552	-2.2907	-26.4707	-181.4165	-0.7845	-1.0593	-3.5573	-24.2139	-184	-1.024	-28.7275	-178.833
	3.568	-2.6122	-26.1518	-182.2896	-0.5943	-1.1406	-4.0359	-23.0494	-184.5964	-1.1886	-29.2542	-179.9829
	3.584	-2.2703	-26.1457	-183.0445	-0.7639	-1.2286	-3.1143	-23.7764	-185.454	-1.4264	-28.515	-180.6351
	3.6	-2.1974	-25.6282	-183.9353	-0.6224	-1.0886	-3.6953	-22.7661	-186.253	-0.6995	-28.4902	-181.6176
	3.616	-1.8985	-25.8697	-184.2252	-0.5998	-1.1269	-3.2505	-23.0268	-186.378	-0.5464	-28.7126	-182.0725
	3.632	-2.2161	-26.6317	-184.9394	-0.6644	-0.9647	-3.6335	-24.5866	-186.8881	-0.7987	-28.6767	-182.9907
	3.648	-2.145	-26.3809	-185.5819	-0.5538	-1.0564	-3.6698	-23.6827	-187.4985	-0.6203	-29.0792	-183.6654
	3.664	-2.0367	-25.8824	-186.6148	-0.5698	-1.0918	-3.5235	-23.02	-188.6812	-0.55	-28.7448	-184.5484
	3.68	-2.1714	-25.4953	-187.8133	-0.6233	-1.0533	-3.7079	-22.7961	-190.0461	-0.6349	-28.1946	-185.5804
	3.696	-2.1773	-25.5068	-188.247	-0.5707	-0.966	-3.946	-22.948	-190.2439	-0.4086	-28.0656	-186.25
	3.712	-1.9133	-25.8958	-189.1034	-0.6611	-1.089	-3.2087	-23.4187	-191.2778	-0.618	-28.3729	-186.929
	3.728	-1.3082	-25.9381	-190.372	-0.6167	-1.3546	-1.9191	-23.1563	-192.3913	-0.6973	-28.7199	-188.3527
	3.744	-0.9746	-26.3573	-191.3162	-0.6574	-1.5345	-1.0789	-23.4883	-193.5323	-0.8703	-29.2263	-189.1002
	3.76	-0.6999	-26.1403	-192.0935	-0.6306	-1.4724	-0.995	-23.152	-194.2856	-0.4048	-29.1285	-189.9013
	3.776	-0.7221	-26.4189	-192.6173	-0.6631	-1.4961	-0.9365	-23.5549	-194.8604	-0.5077	-29.2829	-190.3742
	3.792	-0.4596	-26.4783	-193.8005	-0.7195	-1.556	-0.4984	-23.8528	-196.1013	-0.4208	-29.1038	-191.4997
	3.808	-0.5878	-26.1472	-194.7998	-0.5917	-1.4781	-0.8609	-23.2078	-196.7835	-0.3147	-29.0865	-192.8161
	3.824	-0.2654	-27.3088	-195.6154	-0.6969	-1.4119	-0.6734	-24.7632	-197.7733	0.1426	-29.8544	-193.4574
	3.84	-0.4016	-26.7337	-196.7546	-0.7243	-1.5438	-0.4639	-24.4273	-198.7956	-0.3393	-29.0401	-194.7135
	3.856	0.2959	-26.7633	-197.654	-0.8477	-1.6858	0.5065	-24.9398	-199.7339	0.0853	-28.5867	-195.574
	3.872	0.7119	-26.9101	-198.1564	-0.8108	-1.9325	1.5259	-24.7587	-200.5766	-0.1021	-29.0614	-195.7363
	3.888	1.216	-27.5608	-198.8214	-0.7386	-1.9303	2.0747	-25.2762	-201.0436	0.3573	-29.8454	-196.5993
	3.904	1.0016	-27.4506	-199.769	-0.6584	-2.0548	2.0765	-25.4058	-201.556	-0.0733	-29.4955	-197.982
	3.92	1.4941	-27.6577	-200.6717	-0.7896	-2.0982	2.3872	-26.1241	-202.4613	0.601	-29.1913	-198.8821
	3.936	1.718	-28.1227	-201.9775	-0.7729	-2.0669	2.7491	-26.2173	-204.0905	0.6868	-30.028	-199.8646

Man7	time	pos(x)	pos(y)	pos(z)	el	az	x1	y1	z1	x2	y2	z2
	3.952	1.7682	-27.6962	-203.2663	-0.9372	-2.2123	2.7993	-26.3156	-205.6118	0.7371	-29.0769	-200.9208
	3.968	1.7813	-28.013	-203.9303	-0.9	-2.2096	2.9074	-26.4968	-206.3105	0.6553	-29.5293	-201.5501
	3.984	2.4083	-29.4475	-204.7093	-0.7951	-1.9946	3.4397	-27.1612	-207.2666	1.3769	-31.7338	-202.1521
	4	2.225	-30.4208	-205.2715	-0.9003	-2.3758	3.4545	-29.2385	-207.4222	0.9955	-31.603	-203.1208
	4.016	2.5882	-30.6586	-205.8238	-0.8766	-2.282	3.694	-29.3752	-207.8591	1.4823	-31.9421	-203.7884
	4.032	2.5372	-31.5324	-206.6939	-0.8786	-2.15	3.5857	-29.9292	-209.0043	1.4887	-33.1355	-204.3835
	4.048	2.7639	-31.5209	-207.3642	-0.9706	-2.2961	4.0543	-30.0652	-210.2063	1.4735	-32.9766	-204.5222
	4.064	3.0561	-31.9752	-208.2794	-1.0375	-2.4381	4.2054	-31.0002	-210.8326	1.9068	-32.9502	-205.7263
	4.08	3.1357	-33.1612	-208.6557	-1.0662	-2.6623	4.3923	-32.5082	-211.22	1.8791	-33.8143	-206.0913
	4.096	3.3029	-33.3256	-209.3758	-1.1016	-2.7796	4.4177	-32.9034	-211.7272	2.188	-33.7477	-207.0245
	4.112	3.1897	-33.5883	-209.9915	-1.1237	-2.5448	4.2666	-32.8566	-212.7065	2.1128	-34.32	-207.2764
	4.128	3.6137	-34.2453	-210.6825	-1.1987	-3.043	4.6738	-34.1404	-213.4119	2.5537	-34.3502	-207.953
	4.144	2.9861	-35.0342	-211.0194	-1.203	2.8232	3.8388	-35.3153	-213.3499	2.1333	-34.7531	-208.6889
	4.16	3.4777	-35.2924	-211.7521	-1.3099	2.9804	4.0406	-35.3839	-213.8879	2.9148	-35.2009	-209.6163
	4.176	3.422	-34.9136	-212.7811	-1.1991	2.5065	4.1271	-35.4332	-215.0281	2.717	-34.394	-210.5341
	4.192	3.0974	-35.3719	-212.9631	-0.9836	2.2717	4.066	-36.5198	-215.2199	2.1288	-34.2239	-210.7063
	4.208	3.285	-35.7928	-213.4927	-0.9716	2.3178	4.2982	-36.887	-215.6762	2.2717	-34.6986	-211.3092
	4.224	3.176	-36.686	-213.7008	-1.0617	2.3811	4.1008	-37.5658	-215.9877	2.2512	-35.8061	-211.414
	4.24	3.3637	-37.8496	-214.3665	-1.1519	2.1107	3.838	-38.6409	-216.4386	2.8895	-37.0583	-212.2944
	4.256	3.708	-38.4855	-214.6914	-1.1578	1.9579	4.0621	-39.3541	-216.8321	3.3538	-37.617	-212.5508
	4.272	3.4287	-38.4556	-215.0523	-1.08	2.056	3.9561	-39.456	-217.1684	2.9012	-37.4552	-212.9361
	4.288	3.4428	-38.4176	-215.9143	-1.1705	1.9858	3.898	-39.4507	-218.5822	2.9877	-37.3845	-213.2463
	4.304	3.4847	-38.9502	-216.1215	-1.1302	1.8082	3.7393	-40.0023	-218.4169	3.2301	-37.8982	-213.8261
	4.32	3.4698	-39.5282	-216.2848	-1.1434	1.9978	3.8743	-40.4172	-218.4292	3.0653	-38.6393	-214.1403
	4.336	3.6423	-40.8963	-216.7705	-1.3095	1.8313	3.8013	-41.4926	-219.0783	3.4834	-40.2999	-214.4627
	4.352	3.4851	-41.5375	-216.9052	-1.2061	1.904	3.7568	-42.3225	-219.0812	3.2134	-40.7524	-214.7292
	4.368	3.5348	-41.1215	-217.857	-1.2501	1.7897	3.7035	-41.8795	-220.1946	3.3662	-40.3635	-215.5194
	4.384	3.47	-40.4512	-218.4318	-0.9448	1.731	3.6971	-41.8571	-220.4017	3.2428	-39.0453	-216.462
	4.4	3.5503	-40.629	-219.6149	-1.1103	1.7545	3.7362	-41.6293	-221.6655	3.3644	-39.6288	-217.5642
	4.416	3.3562	-39.8212	-220.7767	-1.0409	1.7519	3.5601	-40.9344	-222.7086	3.1523	-38.7081	-218.8448
	4.432	3.3709	-40.3077	-221.1313	-0.846	1.7332	3.6026	-41.7217	-222.7492	3.1393	-38.8937	-219.5134
	4.448	3.1805	-39.6091	-222.0132	-0.7319	1.828	3.6439	-41.3705	-223.6494	2.7171	-37.8476	-220.3769
	4.464	3.1334	-38.2772	-223.7082	-0.8069	1.8726	3.59	-39.7434	-225.3112	2.6769	-36.8109	-222.1051
	4.48	3.3831	-38.8246	-223.8532	-0.9531	1.8212	3.7132	-40.1155	-225.7288	3.053	-37.5338	-221.9776
	4.496	3.4165	-39.4338	-224.3471	-1.0332	1.553	3.3954	-40.6227	-226.3419	3.4376	-38.2449	-222.3524
	4.512	2.9607	-38.3395	-225.1973	-0.8908	1.759	3.2341	-39.7754	-227.005	2.6872	-36.9036	-223.3897
	4.528	3.3511	-39.0639	-225.6859	-1.003	1.6399	3.4341	-40.2625	-227.5697	3.2682	-37.8652	-223.8021
	4.544	3.3379	-39.7313	-226.6115	-0.9526	1.6351	3.4238	-41.0667	-228.4932	3.252	-38.3959	-224.7297
	4.56	3.0953	-39.2906	-227.2674	-1.025	1.8409	3.3968	-40.3798	-229.1281	2.7938	-38.2014	-225.4067
	4.576	3.4254	-39.8857	-227.6257	-0.9437	1.6354	3.5077	-41.158	-229.3851	3.3431	-38.8135	-225.8663
	4.592	3.0653	-39.7484	-228.2196	-0.808	1.726	3.2831	-41.1404	-229.6939	2.8476	-38.3563	-226.7454
	4.608	3.1787	-40.2471	-229.4026	-1.1974	1.6919	3.2813	-41.09	-231.5702	3.0762	-39.4042	-227.235
	4.624	3.4452	-40.1653	-229.624	-1.3346	1.6136	3.4682	-40.7014	-231.8537	3.4223	-39.6291	-227.3943
	4.64	3.294	-40.5881	-230.0266	-1.229	1.7071	3.3904	-41.2908	-232.0202	3.1976	-39.8854	-228.0329
	4.656	3.092	-39.781	-231.5259	-1.4416	-2.062	3.2337	-39.5161	-233.8386	2.9503	-40.0459	-229.2131
	4.672	2.992	-39.5864	-232.0599	-1.432	1.4893	2.9674	-39.888	-234.2267	3.0166	-39.2847	-229.8931
	4.688	2.9493	-39.404	-232.7093	-1.4771	1.363	2.9053	-39.6128	-234.9796	2.9933	-39.1952	-230.439
	4.704	2.9483	-39.4863	-233.6669	-1.0797	1.6467	3.0157	-40.3722	-235.3283	2.881	-38.6004	-232.0054
	4.72	2.7386	-39.2438	-234.5226	-1.2339	1.7163	2.8396	-39.9329	-236.5115	2.6376	-38.5546	-232.5337
	4.736	2.6707	-39.1341	-235.0903	-1.3006	1.8073	2.8121	-39.7205	-237.2681	2.5294	-38.5476	-232.9126
	4.752	2.8061	-38.8389	-235.9542	-1.3755	-1.5842	2.8139	-38.2543	-238.9093	2.7983	-39.4235	-232.9991
	4.768	2.8169	-38.1544	-237.1042	-1.501	1.9104	2.8787	-38.3296	-239.7627	2.755	-37.9792	-234.4458
	4.784	2.8596	-38.8026	-236.9533	-1.2445	-1.5302	2.8135	-37.6696	-240.3048	2.9056	-39.9356	-233.6018
	4.8	3.129	-39.5602	-237.4272	-1.2983	-1.6138	3.1666	-38.6858	-240.559	3.0914	-40.4345	-234.2954
	4.816	3.4395	-39.2503	-238.4447	-1.2428	-1.5401	3.4044	-38.1055	-241.8103	3.4746	-40.3951	-235.079
	4.832	3.1451	-39.0627	-239.2982	-1.251	-1.8015	3.3857	-38.0382	-242.476	2.9045	-40.0871	-236.1204
	4.848	2.9705	-39.1827	-239.8861	-1.29	-1.6761	3.0659	-38.2798	-243.0338	2.875	-40.0855	-236.7384
	4.864	3.0749	-38.2654	-241.4212	-1.3507	-1.6112	3.1013	-37.6106	-244.3512	3.0484	-38.9203	-238.4912
	4.88	3.153	-38.2299	-242.1527	-1.2682	-1.4571	3.0337	-37.1853	-245.5208	3.2722	-39.2744	-238.7847
	4.896	2.8452	-38.0634	-242.6609	-1.2348	-1.5095	2.7697	-36.8328	-246.1916	2.9208	-39.294	-239.1302
	4.912	2.8523	-38.046	-243.553	-1.2607	-1.5566	2.8362	-36.9057	-247.1116	2.8685	-39.1863	-239.9943
	4.928	3.0575	-37.9947	-244.1053	-1.2671	-1.5702	3.0568	-36.9566	-247.4177	3.0582	-39.0328	-240.7928
	4.944	2.654	-36.9257	-245.3844	-1.2879	-1.7859	2.8655	-35.9575	-248.794	2.4424	-37.8938	-241.9748
	4.96	3.2293	-37.4528	-245.7231	-1.187	-1.7157	3.4397	-36.0109	-249.3321	3.0188	-38.8947	-242.1141
	4.976	3.2914	-37.074	-246.7723	-1.2616	-2.0539	3.7659	-36.1696	-249.9697	2.8169	-37.9785	-243.5749
	4.992	3.1517	-36.9366	-247.6678	-1.2107	-1.8743	3.5168	-35.7706	-250.9131	2.7866	-38.1026	-244.4225

Man7											
time	pos(x)	pos(y)	pos(z)	el	az	x1	y1	z1	x2	y2	z2
5.008	2.8068	-36.2952	-249.0399	-1.1255	-1.769	3.1315	-34.678	-252.4957	2.482	-37.9125	-245.5841
5.024	3.0522	-35.9918	-249.1157	-1.1495	-1.6738	3.1942	-34.6188	-252.1958	2.9103	-37.3648	-246.0355
5.04	2.873	-35.8904	-250.3073	-1.0984	-1.5177	2.7885	-34.3018	-253.4208	2.9575	-37.4791	-247.1939
5.056	3.0194	-35.438	-251.4432	-1.1087	-1.6287	3.1155	-33.7805	-254.777	2.9233	-37.0955	-248.1094
5.072	2.7557	-35.2962	-252.46	-1.1101	-1.6777	2.9454	-33.529	-256.0415	2.566	-37.0635	-248.8786
5.088	3.0323	-35.6062	-252.8967	-1.1268	-1.7467	3.3479	-33.8309	-256.6877	2.7167	-37.3815	-249.1056

Manta											
time	pos(x)	pos(y)	pos(z)	el	az	x1	y1	z1	x2	y2	z2
0	0	0	0	-1.3034	-2.4904	0.3532	0.2691	-1.6211	-0.3532	-0.2691	1.6211
0.016	1.2848	-0.1755	-2.6875	-1.2212	-2.6113	1.8559	0.1593	-4.5032	0.7138	-0.5103	-0.8718
0.032	4.2086	-0.0983	-5.3426	-1.2236	2.8986	5.0955	-0.3181	-7.8674	3.3217	0.1215	-2.8178
0.048	6.1487	-0.4954	-6.8894	-1.0542	2.7698	7.7065	-1.1029	-9.8329	4.591	0.1121	-3.9459
0.064	6.3902	-1.1654	-9.9856	-0.9766	2.8126	7.7821	-1.6406	-12.1625	4.9983	-0.6902	-7.8087
0.08	7.1946	-1.233	-11.4231	-1.0485	2.4108	8.2499	-2.1789	-13.8854	6.1393	-0.287	-8.9608
0.096	7.349	-2.0728	-13.5588	-1.0224	2.5928	8.056	-2.5051	-14.9152	6.642	-1.6405	-12.2025
0.112	8.0635	-2.066	-15.0135	-0.8229	2.74	8.804	-2.3805	-15.8808	7.323	-1.7514	-14.1462
0.128	8.4451	-2.2791	-16.6588	-0.6867	2.7836	9.6621	-2.7344	-17.7241	7.228	-1.8238	-15.5935
0.144	8.3233	-2.5128	-18.0928	-1.1459	2.3524	8.5946	-2.7861	-18.9439	8.052	-2.2395	-17.2417
0.16	8.3548	-2.4257	-19.4175	-1.2688	2.2448	8.5274	-2.6419	-20.3056	8.1821	-2.2095	-18.5294
0.176	7.7568	-2.3789	-19.8571	-1.3936	2.3987	7.9075	-2.5173	-20.9994	7.6061	-2.2406	-18.7148
0.192	7.5737	-2.1151	-20.6793	-1.0928	2.4724	8.2119	-2.6198	-22.2499	6.9356	-1.6103	-19.1087
0.208	7.7666	-1.9522	-21.3719	-1.1962	2.16	8.0831	-2.4257	-22.8203	7.4502	-1.4787	-19.9235
0.224	7.4656	-2.0519	-22.7094	-1.1349	2.8792	8.0298	-2.2035	-23.9634	6.9015	-1.9004	-21.4553
0.24	7.9229	-2.198	-23.7576	-1.3528	2.4521	8.2223	-2.4448	-25.5092	7.6236	-1.9513	-22.006
0.256	7.1916	-1.8928	-24.0427	-1.2955	2.2508	7.5472	-2.3325	-26.0445	6.836	-1.4532	-22.0408
0.272	7.3811	-1.9987	-25.3329	-1.3623	2.2856	7.6198	-2.2737	-27.0542	7.1424	-1.7237	-23.6116
0.288	6.99	-1.9418	-25.7868	-1.4447	2.6374	7.2222	-2.0699	-27.8784	6.7578	-1.8137	-23.6951
0.304	6.8038	-1.4879	-25.801	-1.4633	2.1772	6.9591	-1.7119	-28.3249	6.6485	-1.264	-23.277
0.32	6.9018	-1.9606	-27.3777	-1.3879	-3.0295	7.309	-1.9147	-29.5929	6.4947	-2.0064	-25.1626
0.336	6.9112	-1.8384	-28.4376	-1.5336	2.6371	6.9856	-1.8795	-30.7179	6.8369	-1.7974	-26.1573
0.352	6.567	-1.7478	-28.9769	-1.3184	-2.0767	6.7991	-1.3288	-30.8344	6.3349	-2.1668	-27.1194
0.368	6.691	-1.6908	-29.5515	-1.3728	-1.8052	6.7913	-1.2706	-31.7045	6.5907	-2.1109	-27.3986
0.384	6.1547	-1.4952	-29.6215	-1.4127	-2.8584	6.5142	-1.3905	-31.9701	5.7951	-1.5998	-27.273
0.4	6.0112	-1.3467	-30.1237	-1.4723	-2.3099	6.1607	-1.1826	-32.3699	5.8617	-1.5107	-27.8775
0.416	6.0165	-1.2867	-30.8861	-1.3929	-2.3276	6.3166	-0.969	-33.3176	5.7164	-1.6045	-28.4546
0.432	6.3191	-0.8166	-31.2955	-1.3987	-3.1176	6.7503	-0.8062	-33.7776	5.8879	-0.8269	-28.8134
0.448	6.4254	-0.7232	-31.8297	-1.4767	-0.6177	6.2306	-0.5847	-34.3628	6.6203	-0.8616	-29.2966
0.464	6.0757	-0.3892	-32.4813	-1.4479	-0.2781	5.7794	-0.3046	-34.9757	6.372	-0.4738	-29.9869
0.48	5.5325	-0.5404	-33.4189	-1.493	-0.1896	5.3517	-0.5057	-35.7815	5.7133	-0.5751	-31.0563
0.496	5.5928	-0.9062	-34.2743	-1.4161	-0.5523	5.2489	-0.6943	-36.8637	5.9366	-1.1181	-31.6848
0.512	5.7151	-0.6593	-34.6176	-1.5215	-0.6417	5.6093	-0.5802	-37.2957	5.8209	-0.7383	-31.9396
0.528	5.9596	-0.5837	-35.3251	-1.4456	-0.97	5.7848	-0.3285	-37.782	6.1345	-0.8388	-32.8682
0.544	5.4367	-0.4475	-35.3664	-1.4392	-1.4494	5.398	-0.1306	-37.7777	5.4753	-0.7643	-32.9551
0.56	5.9734	-0.6595	-37.2107	-1.4368	-0.4137	5.6548	-0.5196	-39.7912	6.2921	-0.7994	-34.6302
0.576	5.7069	-0.7662	-37.5782	-1.4326	-0.2562	5.3271	-0.6668	-40.402	6.0867	-0.8657	-34.7545
0.592	5.4941	-0.5429	-38.3325	-1.4111	-0.6691	5.1831	-0.2969	-40.7951	5.8052	-0.7889	-35.8699
0.608	4.8048	-0.0869	-38.8431	-1.4219	-0.4005	4.4372	0.0687	-41.5035	5.1724	-0.2426	-36.1827
0.624	4.8536	-0.2095	-39.4126	-1.3889	-0.5648	4.4709	0.033	-41.8759	5.2362	-0.452	-36.9493
0.64	5.2081	-0.7767	-39.9394	-1.3458	-1.1036	4.9644	-0.2935	-42.3043	5.4519	-1.26	-37.5744
0.656	4.9925	-0.2231	-40.8634	-1.4397	-0.991	4.8262	0.0309	-43.1668	5.1589	-0.4772	-38.5599
0.672	5.6494	0.1688	-41.32	-1.4278	-1.3254	5.5688	0.4907	-43.6256	5.73	-0.1532	-39.0144
0.688	6.0969	0.0996	-42.4964	-1.3111	-0.6451	5.5998	0.4736	-44.8377	6.5939	-0.2745	-40.1552
0.704	5.4081	0.1426	-43.1629	-1.4267	-1.1745	5.2716	0.4689	-45.6014	5.5447	-0.1838	-40.7243
0.72	5.7636	0.0653	-43.956	-1.4516	-1.0821	5.626	0.3241	-46.4025	5.9012	-0.1935	-41.5095
0.736	5.6213	0.0785	-44.4924	-1.2415	-0.7534	5.054	0.6106	-46.7684	6.1887	-0.4536	-42.2164
0.752	5.5898	0.6105	-45.041	-1.4283	-0.5168	5.2713	0.7915	-47.5937	5.9083	0.4295	-42.4882
0.768	5.3153	-0.037	-45.6813	-1.3239	-1.2527	5.1181	0.5619	-48.183	5.5125	-0.6359	-43.1796
0.784	5.654	-0.7512	-47.2996	-1.3606	-0.509	5.1922	-0.4936	-49.7781	6.1158	-1.0089	-44.8211
0.8	5.7478	-0.8311	-47.434	-1.3795	-0.6242	5.3349	-0.5338	-50.0623	6.1607	-1.1285	-44.8058
0.816	5.9638	-0.5508	-48.4602	-1.4255	-2.5855	6.2867	-0.3502	-51.0587	5.641	-0.7515	-45.8617
0.832	6.1734	-0.2395	-49.6592	-1.3765	-1.9248	6.3365	0.2017	-52.0493	6.0104	-0.6807	-47.269
0.848	6.3338	-0.5597	-50.5327	-1.3586	-1.8746	6.5073	-0.0061	-53.2257	6.1603	-1.1132	-47.8397
0.864	6.576	-0.201	-50.9904	-1.3888	-0.9105	6.2878	0.1702	-53.5445	6.8643	-0.5721	-48.4363
0.88	6.2444	0.0937	-51.4602	-1.4129	-2.0277	6.4527	0.5175	-54.4265	6.0361	-0.3301	-48.4938

Man8	time	pos(x)	pos(y)	pos(z)	el	az	x1	y1	z1	x2	y2	z2
	0.896	6.4564	-0.546	-52.664	-1.3691	-1.9264	6.6498	-0.0253	-55.38	6.2631	-1.0667	-49.948
	0.912	6.9075	-0.3747	-53.3302	-1.3387	-1.8682	7.0826	0.1965	-55.8576	6.7325	-0.946	-50.8028
	0.928	6.6846	-0.3388	-54.1997	-1.3446	-2.007	6.9224	0.1712	-56.6444	6.4469	-0.8488	-51.7549
	0.944	6.8401	0.0843	-54.8096	-1.3441	-2.2917	7.228	0.5257	-57.3568	6.4522	-0.3572	-52.2624
	0.96	7.2202	-0.0743	-55.1493	-1.333	-1.9892	7.4375	0.4144	-57.3565	7.0028	-0.5631	-52.9421
	0.976	7.6692	-1.0665	-57.6266	-1.2022	-2.1046	8.0764	-0.3776	-59.6983	7.2621	-1.7554	-55.5549
	0.992	8.5224	-0.8204	-57.8053	-1.0521	-2.7874	9.6938	-0.3872	-59.9932	7.351	-1.2536	-55.6174
	1.008	8.5803	-0.8035	-58.4924	-1.0106	-2.7321	10.0266	-0.1758	-61.0062	7.1339	-1.4313	-55.9785
	1.024	8.5777	-0.8808	-58.7585	-0.904	-2.6536	9.9414	-0.157	-60.7201	7.214	-1.6047	-56.7969
	1.04	8.8064	-0.8946	-59.8743	-0.999	-2.96	10.2462	-0.6303	-62.1488	7.3667	-1.159	-57.5998
	1.056	9.1262	-1.2214	-60.7862	-0.9342	-2.7399	10.5727	-0.607	-62.9121	7.6797	-1.8359	-58.6603
	1.072	9.0714	-0.9182	-61.5074	-0.9868	-2.9998	10.6936	-0.6866	-63.987	7.4491	-1.1498	-59.0278
	1.088	9.5528	-0.7743	-61.8625	-0.8412	3.1117	11.7201	-0.8392	-64.2875	7.3856	-0.7094	-59.4374
	1.104	10.171	-0.7303	-62.3151	-0.9133	-2.9572	12.0335	-0.3828	-64.7691	8.3085	-1.0777	-59.8612
	1.12	10.2372	-0.5524	-62.9373	-0.8838	3.0545	12.2866	-0.7314	-65.4452	8.1878	-0.3734	-60.4293
	1.136	10.5778	-0.958	-64.1383	-0.9059	-3.0911	12.6559	-0.853	-66.7924	8.4996	-1.063	-61.4843
	1.152	10.888	-2.0721	-66.6594	-0.5959	-2.7924	12.8387	-1.3617	-68.0671	8.9373	-2.7824	-65.2518
	1.168	10.6236	-2.0489	-67.4643	-0.3507	-2.781	12.8013	-1.2278	-68.3155	8.446	-2.87	-66.613
	1.184	11.5045	-2.2314	-68.4048	-0.3727	-2.8222	13.8012	-1.4719	-69.3505	9.2077	-2.991	-67.4591
	1.2	11.1227	-1.8482	-68.8852	-0.371	-2.8201	13.6341	-1.0119	-69.9147	8.6114	-2.6845	-67.8556
	1.216	10.5509	-2.2928	-69.6181	-0.4945	-2.7609	12.5129	-1.5076	-70.7576	8.589	-3.078	-68.4785
	1.232	10.6645	-2.1708	-70.4761	-0.5548	-2.5977	12.4527	-1.0894	-71.7711	8.8764	-3.2522	-69.1811
	1.248	10.6716	-2.097	-70.9823	-0.4212	-2.6733	12.6193	-1.1118	-71.9602	8.724	-3.0823	-70.0044
	1.264	10.7698	-1.7155	-71.0277	-0.7704	-2.8964	12.5813	-1.2622	-72.84	8.9582	-2.1687	-69.2155
	1.28	10.9608	-1.8875	-71.8703	-0.8308	-2.991	12.5882	-1.6405	-73.6729	9.3334	-2.1345	-70.0676
	1.296	11.7586	-2.01	-72.5123	-0.6459	-3.0084	13.7358	-1.7451	-74.016	9.7815	-2.275	-71.0086
	1.312	11.9916	-2.3077	-73.7239	-0.6589	-3.0069	14.0031	-2.0351	-75.2957	9.9802	-2.5804	-72.1522
	1.328	12.3783	-2.1102	-74.3957	-0.7421	-2.9923	13.9136	-1.8794	-75.8194	10.8431	-2.3411	-72.972
	1.344	12.9158	-2.3361	-74.9645	-0.7039	-2.941	14.8411	-1.9446	-76.6323	10.9905	-2.7276	-73.2967
	1.36	12.6624	-2.3526	-75.7365	-0.7101	-2.9524	14.4953	-2.0018	-77.3409	10.8295	-2.7035	-74.1321
	1.376	13.5112	-2.5566	-76.6976	-0.8313	-2.9842	15.0568	-2.3113	-78.4133	11.9655	-2.8018	-74.9819
	1.392	13.6814	-3.0168	-77.8371	-0.7782	-3.0355	15.3574	-2.8384	-79.4984	12.0054	-3.1952	-76.1757
	1.408	14.3916	-3.4174	-78.4059	-0.6569	-2.9816	16.4133	-3.0912	-79.9853	12.3698	-3.7436	-76.8265
	1.424	13.8783	-3.4452	-79.4931	-0.6151	-3.0554	16.264	-3.2391	-81.1849	11.4926	-3.6513	-77.8012
	1.44	14.8605	-3.3256	-79.2016	-0.7119	3.1307	17.0408	-3.3492	-81.0829	12.6802	-3.3019	-77.3203
	1.456	14.9959	-3.1966	-80.1665	-0.7466	-3.0688	17.091	-3.0439	-82.11	12.9009	-3.3493	-78.223
	1.472	14.6138	-3.2582	-81.2276	-0.8529	-3.1066	16.2711	-3.2001	-83.1265	12.9564	-3.3162	-79.3287
	1.488	14.2691	-3.289	-82.0441	-0.9364	3.1145	15.6116	-3.3254	-83.8692	12.9266	-3.2526	-80.2189
	1.504	14.4905	-3.5454	-83.3018	-0.9219	-3.1011	15.8899	-3.4886	-85.1483	13.0911	-3.6021	-81.4554
	1.52	14.3618	-3.8007	-84.115	-0.7389	-3.0991	16.0081	-3.7307	-85.6163	12.7155	-3.8707	-82.6136
	1.536	14.7906	-3.8383	-84.6225	-0.8807	-3.0875	16.1985	-3.762	-86.3306	13.3828	-3.9146	-82.9145
	1.552	14.7569	-3.8108	-84.4632	-1.1385	2.9254	15.812	-4.0425	-86.8046	13.7017	-3.5791	-82.1218
	1.568	15.176	-4.3746	-85.8851	-1.3071	3.0249	15.7257	-4.4391	-87.9346	14.6264	-4.3102	-83.8356
	1.584	14.9233	-3.9879	-86.4057	-1.2504	-3.0771	15.6566	-3.9405	-88.6205	14.19	-4.0352	-84.1909
	1.6	15.1488	-4.5039	-87.6489	-1.3016	3.0055	15.7122	-4.5811	-89.71	14.5853	-4.4268	-85.5879
	1.616	14.3144	-4.6308	-88.0822	-1.2739	-2.9625	14.9203	-4.5211	-90.0946	13.7085	-4.7405	-86.0698
	1.632	14.4255	-4.6643	-89.3026	-1.2834	3.0328	15.0673	-4.7344	-91.4865	13.7838	-4.5942	-87.1186
	1.648	14.3345	-4.3136	-89.4747	-1.2422	2.3816	15.0283	-4.973	-92.2823	13.6407	-3.6541	-86.6671
	1.664	14.4402	-4.3915	-90.7235	-1.364	1.8195	14.587	-4.9696	-93.567	14.2934	-3.8133	-87.8801
	1.68	14.9006	-4.5581	-91.6238	-1.2997	1.7779	15.0502	-5.2701	-94.242	14.751	-3.8461	-89.0057
	1.696	14.8542	-4.8792	-92.4192	-1.3263	1.5359	14.8306	-5.5555	-95.1311	14.8778	-4.203	-89.7073
	1.712	14.7003	-5.2161	-92.8277	-1.3677	1.684	14.7615	-5.7548	-95.4596	14.6391	-4.6775	-90.1958
	1.728	13.9308	-5.025	-93.274	-1.3622	1.6439	13.9812	-5.7137	-96.5368	13.8803	-4.3362	-90.0113
	1.744	14.3115	-5.427	-94.2581	-1.3883	1.5267	14.2862	-6	-97.3662	14.3367	-4.8541	-91.1499
	1.76	14.1526	-5.6	-95.121	-1.4289	1.4094	14.0818	-6.0347	-98.2047	14.2233	-5.1652	-92.0372
	1.776	13.8845	-5.8684	-96.0934	-1.3592	1.3251	13.7225	-6.5144	-99.1942	14.0464	-5.2224	-92.9925
	1.792	14.1805	-5.7434	-96.8226	-1.4062	1.3311	14.0695	-6.1976	-99.6389	14.2916	-5.2891	-94.0063
	1.808	13.8561	-5.6646	-97.6201	-1.2589	0.7066	13.1429	-6.2734	-100.5287	14.5692	-5.0558	-94.7115
	1.824	13.4898	-5.72	-98.4205	-1.1042	0.6273	12.3358	-6.5566	-101.2506	14.6439	-4.8834	-95.5903
	1.84	13.2302	-5.3943	-98.9212	-1.1872	0.5913	12.3464	-5.9878	-101.5585	14.1139	-4.8009	-96.2838
	1.856	12.7197	-5.6923	-99.8151	-1.0719	0.506	11.4939	-6.3715	-102.3871	13.9456	-5.0131	-97.2431
	1.872	12.6077	-6.1866	-101.4012	-1.0359	0.6336	11.2797	-7.1622	-104.1819	13.9357	-5.2111	-98.6205
	1.888	12.3407	-6.163	-101.2917	-1.0575	0.5189	11.1242	-6.8577	-103.7767	13.5573	-5.4683	-98.8066
	1.904	12.3356	-5.9331	-102.6535	-0.9745	0.7062	10.9927	-7.0785	-105.2542	13.6784	-4.7877	-100.0527
	1.92	12.1561	-5.8861	-103.3006	-0.9294	0.5644	10.4459	-6.9687	-106.0115	13.8664	-4.8034	-100.5897
	1.936	11.7426	-6.4518	-103.9909	-0.9611	0.5722	10.2073	-7.4406	-106.6054	13.2779	-5.463	-101.3764

Man8	time	pos(x)	pos(y)	pos(z)	el	az	x1	y1	z1	x2	y2	z2
	1.952	12.1241	-6.5193	-104.5716	-1.0153	0.7057	10.8401	-7.6133	-107.2893	13.408	-5.4254	-101.8539
	1.968	11.3093	-6.5903	-105.8149	-0.9886	0.7475	9.9228	-7.8754	-108.6866	12.6957	-5.3051	-102.9433
	1.984	11.6696	-6.929	-106.904	-0.9814	0.4349	10.0825	-7.6663	-109.5211	13.2568	-6.1916	-104.2869
	2	11.6076	-6.7671	-107.538	-0.93	0.7974	10.0259	-8.3873	-110.5738	13.1894	-5.1468	-104.5021
	2.016	11.3809	-6.8097	-107.8319	-0.9868	0.684	10.0788	-7.8713	-110.3739	12.683	-5.7482	-105.2899
	2.032	11.8422	-7.0999	-109.2733	-0.9235	0.669	10.2087	-8.3915	-112.0283	13.4758	-5.8083	-106.5182
	2.048	12.2585	-7.1791	-110.2257	-0.9914	0.8146	11.0332	-8.4781	-112.9547	13.4839	-5.8801	-107.4967
	2.064	11.879	-6.6206	-110.7835	-0.9245	0.4933	10.279	-7.4809	-113.1914	13.4789	-5.7604	-108.3755
	2.08	11.709	-6.8447	-111.7647	-0.972	0.6974	10.2603	-8.0585	-114.5342	13.1576	-5.631	-108.9953
	2.096	12.4724	-6.7804	-112.7573	-0.9233	0.6441	10.9422	-7.9293	-115.2876	14.0026	-5.6314	-110.2269
	2.112	12.5038	-6.8351	-113.5281	-0.9661	0.5942	10.966	-7.8741	-116.2138	14.0417	-5.7962	-110.8424
	2.128	12.5237	-6.8459	-114.5651	-0.9787	0.7727	11.1263	-8.2082	-117.4668	13.9211	-5.4836	-111.6634
	2.144	12.1592	-7.2703	-115.2843	-1.0824	0.7204	11.1246	-8.1785	-117.8755	13.1938	-6.3621	-112.6931
	2.16	12.7446	-7.1007	-116.3896	-1.0913	0.5286	11.5099	-7.8218	-119.1392	13.9793	-6.3795	-113.64
	2.176	13.2572	-7.6826	-117.3129	-1.1834	0.4145	12.2775	-8.1137	-119.9361	14.2368	-7.2516	-114.6897
	2.192	13.325	-6.9306	-117.5004	-1.1799	0.1577	12.2045	-7.1088	-120.2531	14.4455	-6.7525	-114.7477
	2.208	13.9991	-7.7309	-119.0678	-1.2186	0.3726	12.979	-8.1296	-122.0475	15.0192	-7.3322	-116.088
	2.224	14.7489	-6.9924	-119.7524	-1.2127	0.233	13.7975	-7.2182	-122.3652	15.7003	-6.7666	-117.1397
	2.24	15.1927	-6.9978	-120.5235	-1.2623	0.0884	14.3385	-7.0736	-123.2144	16.047	-6.9221	-117.8326
	2.256	15.6674	-7.098	-121.5109	-1.2516	0.0888	14.6873	-7.1853	-124.4878	16.6474	-7.0108	-118.5341
	2.272	15.4469	-6.3404	-122.0631	-1.3831	0.1397	14.9128	-6.4155	-124.9033	15.981	-6.2653	-119.2228
	2.288	15.994	-6.6253	-122.7456	-1.3899	-0.558	15.5674	-6.3591	-125.4954	16.4205	-6.8916	-119.9959
	2.304	15.7769	-5.7592	-123.8592	-1.2683	-0.5369	15.0479	-5.3253	-126.5776	16.5059	-6.1932	-121.1407
	2.32	15.9407	-5.7611	-124.5526	-1.3589	-1.16	15.7093	-5.2299	-127.2459	16.1721	-6.2924	-121.8592
	2.336	16.6261	-5.5819	-125.3301	-1.3956	-1.491	16.5857	-5.0769	-128.1916	16.6664	-6.087	-122.4686
	2.352	17.1584	-5.4036	-126.0708	-1.2405	-2.1297	17.6171	-4.6701	-128.5937	16.6997	-6.1371	-123.5478
	2.368	17.6793	-4.7458	-126.7476	-1.2897	-2.3277	18.1753	-4.2207	-129.2496	17.1832	-5.2709	-124.2457
	2.384	18.6465	-4.8323	-127.4376	-1.1733	-2.1225	19.1998	-3.9332	-129.9522	18.0931	-5.7314	-124.923
	2.4	18.8757	-4.4773	-128.4671	-1.249	-2.2477	19.421	-3.7987	-131.079	18.3303	-5.156	-125.8553
	2.416	19.193	-4.7078	-129.129	-1.0441	-2.1532	19.9924	-3.4939	-131.6289	18.3935	-5.9218	-126.6292
	2.432	19.1878	-4.5718	-129.8191	-1.0008	-2.4181	20.3759	-3.5223	-132.2924	17.9996	-5.6214	-127.3458
	2.448	19.9647	-4.8031	-130.8066	-0.8802	-2.3161	21.4468	-3.1968	-133.4513	18.4825	-6.4093	-128.1619
	2.464	19.6118	-4.5642	-131.008	-0.7737	-2.3608	21.3152	-2.8763	-133.3507	17.9085	-6.2521	-128.6653
	2.48	20.6207	-4.4177	-132.1927	-0.8537	-2.3482	22.2001	-2.8128	-134.7752	19.0413	-6.0225	-129.6103
	2.496	21.1302	-4.0526	-132.8542	-0.7493	-2.4617	22.9204	-2.6053	-134.9957	19.34	-5.4999	-130.7127
	2.512	21.5885	-4.2408	-133.4666	-0.7651	-2.6931	23.835	-3.1596	-135.8607	19.3421	-5.3219	-131.0726
	2.528	22.1217	-4.0863	-134.1312	-0.695	-2.753	24.5235	-3.1029	-136.2949	19.7199	-5.0697	-131.9675
	2.544	22.8492	-4.5468	-134.7738	-0.7104	-2.6176	25.3501	-3.1017	-137.2587	20.3482	-5.992	-132.2889
	2.56	23.3117	-3.4894	-135.0754	-0.7786	-2.75	25.6352	-2.53	-137.5555	20.9882	-4.4488	-132.5954
	2.576	23.4865	-4.4847	-137.0373	-0.8057	-2.7854	25.7872	-3.6288	-139.5937	21.1858	-5.3406	-134.481
	2.592	23.5477	-4.2741	-137.8724	-0.7565	-2.8112	26.1939	-3.3665	-140.5127	20.9015	-5.1817	-135.232
	2.608	24.2057	-4.4342	-138.5508	-0.6754	-2.7885	26.8428	-3.4622	-140.8024	21.5685	-5.4062	-136.2991
	2.624	23.9139	-4.2843	-138.7845	-0.6983	-2.754	26.2255	-3.3407	-140.8805	21.6024	-5.2279	-136.6886
	2.64	24.381	-4.0887	-140.062	-0.6611	-2.8363	27.0914	-3.2345	-142.2728	21.6706	-4.9429	-137.8513
	2.656	24.992	-4.6277	-140.7416	-0.6638	-2.8171	27.7962	-3.6845	-143.0559	22.1878	-5.571	-138.4272
	2.672	25.0729	-4.5373	-141.4336	-0.6565	-2.7484	27.7693	-3.419	-143.6829	22.3765	-5.6557	-139.1842
	2.688	24.4812	-4.2361	-142.2536	-0.7674	-2.9032	26.3834	-3.7738	-144.1421	22.579	-4.6983	-140.3651
	2.704	24.233	-4.5736	-142.8435	-0.7403	-2.7842	26.3619	-3.7786	-144.9196	22.1041	-5.3686	-140.7675
	2.72	24.6629	-4.1659	-143.6018	-0.7686	-2.7057	26.4822	-3.3185	-145.5423	22.8436	-5.0132	-141.6614
	2.736	24.9431	-4.7458	-144.7296	-0.7909	-2.8317	26.781	-4.1573	-146.6807	23.1052	-5.3344	-142.7784
	2.752	24.9263	-5.0299	-145.6233	-0.7892	-2.7467	26.9794	-4.1741	-147.8644	22.8733	-5.8858	-143.3822
	2.768	24.8782	-4.8582	-146.5458	-0.6817	-2.6049	26.7453	-3.7475	-148.3085	23.0112	-5.9689	-144.7831
	2.784	24.972	-4.033	-147.5732	-0.9084	-3.078	26.8823	-3.9113	-150.0274	23.0617	-4.1548	-145.119
	2.8	25.2755	-4.5338	-148.2812	-0.8085	-2.9878	27.2943	-4.2209	-150.4207	23.2567	-4.8467	-146.1417
	2.816	25.6026	-4.2832	-149.5404	-0.952	3.0593	27.2894	-4.4224	-151.9172	23.9159	-4.144	-147.1637
	2.832	24.6091	-4.3222	-150.3098	-0.958	-3.0913	26.3366	-4.2353	-152.7696	22.8817	-4.4092	-147.8499
	2.848	24.8589	-4.6931	-151.1244	-0.9698	3.0186	26.3467	-4.877	-153.3108	23.3712	-4.5091	-148.938
	2.864	25.602	-4.7934	-152.1776	-1.2153	2.9379	26.5108	-4.9811	-154.6771	24.6931	-4.6056	-149.6781
	2.88	25.1493	-5.6146	-152.6864	-1.1758	3.0546	26.1626	-5.7029	-155.1259	24.136	-5.5263	-150.2468
	2.896	24.7783	-5.2288	-153.7692	-1.2195	2.7266	25.5658	-5.5757	-156.1171	23.9909	-4.8818	-151.4212
	2.912	24.9834	-5.4963	-154.5809	-1.3356	2.6976	25.5338	-5.7581	-157.1242	24.4329	-5.2344	-152.0375
	2.928	25.2911	-5.9536	-155.266	-1.3522	2.5433	25.7407	-6.2601	-157.7155	24.8415	-5.6471	-152.8165
	2.944	24.4196	-6.1754	-155.9953	-1.4743	2.1955	24.5729	-6.388	-158.7037	24.2662	-5.9628	-153.2869
	2.96	24.4704	-6.7285	-156.745	-1.4319	1.433	24.4278	-7.0358	-158.9645	24.513	-6.4213	-154.5256
	2.976	24.113	-6.8646	-157.7587	-1.4188	1.4227	24.0557	-7.2485	-160.2922	24.1703	-6.4807	-155.2252
	2.992	24.3877	-6.3771	-158.6052	-1.311	1.1461	24.1032	-7.0064	-161.203	24.6723	-5.7479	-156.0074

Man8	time	pos(x)	pos(y)	pos(z)	el	az	x1	y1	z1	x2	y2	z2
	3.008	24.4014	-6.6961	-159.5261	-1.3298	1.0268	24.0692	-7.2454	-162.1382	24.7336	-6.1469	-156.914
	3.024	24.0704	-6.4053	-160.2869	-1.1877	0.9355	23.4162	-7.2927	-163.0228	24.7247	-5.5179	-157.5511
	3.04	23.7196	-8.3966	-160.6497	-1.0332	1.1057	23.0456	-9.7399	-163.1707	24.3937	-7.0532	-158.1288
	3.056	23.6872	-8.2053	-161.5933	-1.1129	0.7166	22.7334	-9.0361	-164.1599	24.641	-7.3744	-159.0266
	3.072	23.0036	-8.475	-162.4267	-1.1053	0.8763	22.1783	-9.4657	-164.9936	23.8288	-7.4842	-159.8597
	3.088	23.1118	-8.7108	-163.0857	-1.1081	0.7253	22.1526	-9.5611	-165.6554	24.071	-7.8606	-160.516
	3.104	23.0284	-8.3366	-163.5674	-1.0843	1.095	22.5237	-9.316	-165.6506	23.5331	-7.3572	-161.4842
	3.12	22.8317	-8.6152	-164.4018	-1.0169	0.8313	21.8208	-9.7235	-166.8271	23.8427	-7.5069	-161.9764
	3.136	23.4063	-8.6583	-165.6417	-1.0482	0.8835	22.4646	-9.8055	-168.2187	24.3481	-7.511	-163.0648
	3.152	23.4661	-8.3799	-166.5219	-1.0193	1.0074	22.656	-9.6624	-168.9878	24.2762	-7.0974	-164.056
	3.168	22.9822	-8.7887	-167.1145	-1.019	0.9603	22.1042	-10.0436	-169.6026	23.8601	-7.5339	-164.6265
	3.184	22.7427	-8.7784	-168.0469	-0.9853	0.828	21.8403	-9.7612	-170.0592	23.6452	-7.7956	-166.0347
	3.2	22.6481	-8.8689	-168.7227	-1.0012	1.1372	22.1125	-10.026	-170.7137	23.1838	-7.7118	-166.7317
	3.216	23.1427	-8.9284	-170.065	-0.8332	0.9714	22.0193	-10.5726	-172.2566	24.2662	-7.2841	-167.8735
	3.232	22.9094	-8.8931	-170.6004	-0.9396	1.0298	22.0889	-10.2586	-172.7801	23.7298	-7.5275	-168.4207
	3.248	23.4031	-9.2696	-171.7306	-0.853	0.7803	22.2127	-10.4479	-173.6489	24.5935	-8.0912	-169.8124
	3.264	22.8436	-8.8895	-172.7569	-0.8834	1.1754	22.2515	-10.3083	-174.6294	23.4357	-7.4708	-170.8843
	3.28	23.4509	-9.0872	-173.7642	-0.9285	0.9621	22.5616	-10.3632	-175.8431	24.3403	-7.8112	-171.6854
	3.296	22.3733	-8.9874	-174.8746	-0.8418	0.6644	20.6859	-10.309	-177.2743	24.0606	-7.6659	-172.4749
	3.312	23.5621	-8.6806	-175.7246	-0.7805	0.6635	21.8492	-10.0198	-177.8778	25.2749	-7.3415	-173.5714
	3.328	24.6886	-8.9959	-177.0056	-1.0705	0.8916	23.9371	-9.9267	-179.1936	25.4401	-8.0651	-174.8176
	3.344	24.343	-8.776	-177.49	-1.1375	0.4473	23.2886	-9.2818	-180.0178	25.3974	-8.2702	-174.9621
	3.36	24.501	-8.4517	-178.3988	-1.079	0.2893	23.3992	-8.7797	-180.5451	25.6029	-8.1237	-176.2525
	3.376	24.7938	-8.2758	-179.3246	-1.1723	0.3735	23.7528	-8.6838	-181.9802	25.8348	-7.8679	-176.669
	3.392	25.0533	-8.2429	-180.1335	-1.0563	0.7641	24.1422	-9.116	-182.3656	25.9644	-7.3698	-177.9014
	3.408	25.5544	-8.1775	-180.6624	-1.0986	0.1634	24.1438	-8.4101	-183.4614	26.965	-7.9449	-177.8635
	3.424	24.9826	-7.8759	-181.9343	-1.2159	0.179	24.0697	-8.0411	-184.4379	25.8956	-7.7108	-179.4306
	3.44	25.2738	-7.668	-182.635	-1.2728	-0.5356	24.5737	-7.2525	-185.2857	25.9738	-8.0834	-179.9843
	3.456	26.2215	-7.1566	-183.7801	-1.1778	-0.2843	25.1677	-6.8487	-186.4286	27.2753	-7.4645	-181.1316
	3.472	26.0264	-6.593	-184.0282	-1.1931	-0.6429	25.2011	-5.9747	-186.6274	26.8518	-7.2113	-181.429
	3.488	26.1583	-6.0861	-185.0998	-1.2848	-0.5298	25.4471	-5.6696	-187.903	26.8696	-6.5027	-182.2966
	3.504	25.6993	-5.9066	-185.7172	-1.4307	-1.4079	25.6385	-5.5366	-188.3757	25.7601	-6.2766	-183.0587
	3.52	26.3474	-5.3247	-186.979	-1.2607	-1.8276	26.5686	-4.4823	-189.6974	26.1262	-6.1672	-184.2605
	3.536	26.3329	-5.0432	-187.5764	-1.2025	-1.9057	26.6525	-4.1247	-190.0963	26.0133	-5.9617	-185.0566
	3.552	25.9582	-4.8812	-188.5375	-1.2019	-1.974	26.3746	-3.905	-191.2829	25.5417	-5.8574	-185.7921
	3.568	26.6548	-4.4884	-189.5057	-1.0332	-2.1045	27.3997	-3.2279	-191.9618	25.9098	-5.749	-187.0495
	3.584	26.6536	-4.1441	-190.334	-1.0776	-1.8194	26.9928	-2.8081	-192.8981	26.3144	-5.4801	-187.7698
	3.6	26.4493	-3.559	-190.7425	-0.9485	-1.8119	26.8603	-1.8878	-193.1417	26.0384	-5.2303	-188.3433
	3.616	26.9823	-2.8125	-191.6204	-1.0666	-1.8201	27.2782	-1.6503	-193.7941	26.6864	-3.9748	-189.4467
	3.632	27.4651	-3.018	-192.1221	-1.0185	-2.0608	28.158	-1.7191	-194.5111	26.7722	-4.3169	-189.7332
	3.648	27.6225	-2.3959	-193.0063	-0.8925	-2.0846	28.5877	-0.6857	-195.4432	26.6573	-4.106	-190.5695
	3.664	28.4494	-2.9557	-193.7887	-0.9611	-2.1649	29.4709	-1.4436	-196.4012	27.4278	-4.4678	-191.1762
	3.68	28.7572	-2.834	-195.0912	-0.8786	-2.3646	30.1934	-1.4216	-197.5211	27.321	-4.2464	-192.6613
	3.696	28.7008	-2.6814	-195.7229	-0.8408	-2.1204	29.7903	-0.9029	-198.0537	27.6114	-4.4599	-193.3921
	3.712	29.1506	-2.3694	-197.0328	-0.9219	-2.2217	30.395	-0.7355	-199.7404	27.9062	-4.0033	-194.3251
	3.728	29.5125	-2.6691	-197.6674	-0.8688	-2.4137	31.1515	-1.2084	-200.2635	27.8734	-4.1297	-195.0713
	3.744	29.5035	-2.7541	-198.4918	-0.7609	-2.3115	31.2547	-0.839	-200.9629	27.7522	-4.6692	-196.0207
	3.76	29.6215	-2.0254	-199.2885	-0.8341	-2.4043	31.3964	-0.4137	-201.9315	27.8467	-3.6371	-196.6454
	3.776	29.7867	-1.4411	-199.905	-0.7891	-2.2296	31.5652	0.8562	-202.8317	28.0082	-3.7384	-196.9782
	3.792	29.6266	-1.6812	-201.0613	-0.8098	-2.4463	31.4684	-0.1446	-203.5801	27.7848	-3.2177	-198.5425
	3.808	30.5717	-2.1226	-201.5434	-0.7709	-2.2522	32.4717	0.2201	-204.4735	28.6717	-4.4652	-198.6132
	3.824	30.0972	-1.9303	-202.5367	-0.8243	-2.355	31.8237	-0.1999	-205.179	28.3707	-3.6608	-199.8944
	3.84	30.5775	-1.5007	-203.423	-0.8291	-2.3183	32.3686	0.4315	-206.2983	28.7864	-3.4329	-200.5476
	3.856	30.1678	-1.3986	-203.9971	-0.8105	-2.4285	32.1568	0.3218	-206.7623	28.1788	-3.119	-201.2318
	3.872	30.9897	-0.9986	-205.4062	-0.805	-2.3794	32.8307	0.7588	-208.0533	29.1487	-2.7559	-202.7591
	3.888	30.7297	-1.6755	-206.0247	-0.8177	-2.4528	32.8136	0.0401	-208.9041	28.6458	-3.3912	-203.1453
	3.904	30.823	-1.3341	-206.9524	-0.8934	-2.5721	32.7792	-0.0816	-209.8401	28.8669	-2.5866	-204.0648
	3.92	31.1591	-1.4636	-207.4916	-0.89	-2.5413	33.1608	-0.0935	-210.4863	29.1575	-2.8338	-204.4969
	3.936	30.933	-1.5603	-208.6657	-0.9667	-2.4745	32.3124	-0.474	-211.2098	29.5537	-2.6466	-206.1216
	3.952	30.7319	-1.996	-209.0258	-1.0445	-2.324	31.882	-0.7693	-211.92	29.5818	-3.2228	-206.1315
	3.968	31.0856	-1.9999	-210.2998	-1.008	-2.6493	32.6835	-1.1429	-213.1742	29.4877	-2.8569	-207.4255
	3.984	30.5695	-1.9598	-210.9685	-1.038	-2.6924	32.1389	-1.2032	-213.923	29	-2.7164	-208.0139
	4	30.7154	-1.4231	-212.1741	-1.0963	-2.9833	32.3289	-1.1656	-215.3548	29.1019	-1.6806	-208.9934
	4.016	30.7782	-1.5247	-212.7655	-1.154	-3.0838	32.0693	-1.45	-215.6864	29.4872	-1.5995	-209.8445
	4.032	30.56	-2.2912	-213.7045	-0.9392	2.7044	32.2965	-3.1029	-216.3247	28.8234	-1.4795	-211.0842
	4.048	30.6325	-2.6759	-214.0352	-1.039	2.9665	32.1507	-2.9446	-216.6556	29.1143	-2.4073	-211.4148

Man8	time	pos(x)	pos(y)	pos(z)	el	az	x1	y1	z1	x2	y2	z2
	4.064	31.2665	-3.4851	-215.2175	-1.2996	2.6149	32.0403	-3.935	-218.4371	30.4927	-3.0352	-211.9978
	4.08	30.6547	-3.0259	-216.2397	-1.109	2.8024	32.0338	-3.5125	-219.1778	29.2756	-2.5392	-213.3015
	4.096	30.0759	-3.1919	-216.828	-1.0796	2.6361	31.3725	-3.9094	-219.5983	28.7793	-2.4743	-214.0577
	4.112	30.1154	-2.7445	-217.3577	-0.9362	2.6125	31.949	-3.8166	-220.2429	28.2819	-1.6724	-214.4726
	4.128	31.911	-2.9288	-218.5976	-1.1407	2.2766	32.6323	-3.7751	-221.0217	31.1898	-2.0825	-216.1735
	4.144	30.6644	-3.154	-219.3217	-1.1396	2.2836	31.535	-4.1613	-222.2152	29.7937	-2.1467	-216.4281
	4.16	30.6743	-3.1937	-220.6676	-1.147	2.1721	31.3733	-4.2125	-223.4067	29.9753	-2.1749	-217.9285
	4.176	30.9645	-3.7714	-221.3776	-1.1034	2.3732	31.9279	-4.7026	-224.0327	30.0011	-2.8403	-218.7226
	4.192	31.1645	-3.4818	-222.4569	-1.0282	2.0836	31.7816	-4.5779	-224.5432	30.5474	-2.3858	-220.3705
	4.208	31.274	-3.6434	-223.6736	-1.1955	2.008	31.6217	-4.3874	-225.7583	30.9263	-2.8994	-221.589
	4.224	31.5394	-4.1513	-224.4667	-1.1779	1.8416	31.7721	-4.9897	-226.5664	31.3066	-3.3128	-222.367
	4.24	31.0897	-3.9145	-224.9338	-0.9214	1.8888	31.5425	-5.2899	-226.8409	30.637	-2.539	-223.0267
	4.256	31.4122	-3.8388	-225.8291	-1.0419	1.4888	31.3238	-4.9154	-227.6774	31.5006	-2.7622	-223.9807
	4.272	31.6609	-3.8808	-226.5656	-0.8918	1.613	31.7208	-5.3023	-228.3285	31.6009	-2.4594	-224.8027
	4.288	31.7549	-3.8722	-227.9278	-0.779	1.5746	31.7618	-5.7013	-229.7336	31.7481	-2.043	-226.1219
	4.304	32.0916	-3.301	-228.9792	-0.9148	1.6733	32.2374	-4.7185	-230.8305	31.9459	-1.8836	-227.1279
	4.32	32.0229	-3.2859	-230.2142	-0.8299	1.6198	32.0894	-4.6438	-231.7004	31.9564	-1.9281	-228.728
	4.336	31.8212	-4.4134	-229.7687	-0.9114	1.8186	32.2679	-6.1789	-232.1179	31.3744	-2.648	-229.4194
	4.352	31.3492	-3.6593	-231.2123	-0.8501	1.6528	31.487	-5.3368	-233.1286	31.2114	-1.9819	-227.296
	4.368	31.3314	-3.3469	-232.3418	-0.8029	1.8641	31.8796	-5.1622	-234.3055	30.7832	-1.5315	-230.378
	4.384	31.5269	-3.6458	-233.632	-0.7519	1.609	31.5973	-5.4873	-235.3552	31.4565	-1.8043	-231.9088
	4.4	31.7862	-3.3301	-234.5336	-0.9464	1.8388	32.1783	-4.7582	-236.589	31.394	-1.9021	-232.4782
	4.416	31.4501	-2.7736	-235.7228	-0.8877	1.6072	31.519	-4.6664	-238.0501	31.3812	-0.8808	-233.3955
	4.432	31.4035	-3.2464	-236.3128	-1.0012	1.6241	31.4845	-4.7647	-238.6869	31.3225	-1.728	-233.9387
	4.448	31.4177	-2.611	-237.5338	-0.9873	1.5811	31.4359	-4.3842	-240.2197	31.3994	-0.8378	-234.8479
	4.464	31.8501	-1.7843	-239.1922	-0.9153	1.7328	32.1749	-3.772	-241.8115	31.5253	0.2035	-236.5729
	4.48	31.6521	-1.3785	-240.3324	-1.063	1.2951	31.2622	-2.7564	-242.9056	32.0419	-0.0006	-237.7593
	4.496	31.4149	-1.8478	-241.3076	-1.1832	1.8696	31.7394	-2.9013	-244.0079	31.0904	-0.7942	-238.6074
	4.512	31.5378	-2.3608	-241.6231	-1.0682	1.2831	31.1318	-3.7329	-244.2263	31.9439	-0.9886	-239.0199
	4.528	31.0403	-3.0076	-242.4564	-1.1032	1.5801	31.0516	-4.2315	-244.88	31.0289	-1.7838	-240.0328
	4.544	31.0489	-3.154	-243.1006	-1.0243	1.2929	30.66	-4.5169	-245.4302	31.4377	-1.7911	-240.7709
	4.56	30.9043	-3.2587	-244.0409	-1.1417	1.2314	30.8835	-4.4506	-246.8033	31.3251	-2.0668	-241.2785
	4.576	31.2001	-3.1078	-244.8691	-1.2153	0.9564	30.603	-3.9542	-247.659	31.7973	-2.2614	-242.0792
	4.592	31.4696	-2.2483	-246.3976	-1.2486	0.9492	30.922	-3.0129	-249.2145	32.0173	-1.4838	-243.5806
	4.608	30.8857	-2.3033	-247.4738	-1.3282	0.9646	30.4606	-2.9165	-250.4889	31.3108	-1.6901	-244.4588
	4.624	30.4534	-1.9228	-247.9917	-1.2358	1.438	30.325	-2.8841	-250.7775	30.5818	-0.9615	-245.2059
	4.64	30.5287	-1.7216	-249.1272	-1.3893	1.2434	30.3441	-2.2652	-252.2545	30.7133	-1.178	-245.9999
	4.656	31.2666	-1.4236	-250.182	-1.284	0.8009	30.633	-2.0772	-253.2684	31.9001	-0.7701	-247.0956
	4.672	31.0906	-1.1279	-251.3572	-1.2705	0.7066	30.358	-1.7532	-254.4677	31.8231	-0.5027	-248.2468
	4.688	30.8968	-1.2397	-252.4399	-1.4796	0.4979	30.6366	-1.3812	-255.6803	31.157	-1.0983	-249.1995
	4.704	30.9326	-1.0046	-253.676	-1.4286	0.2205	30.5555	-1.0891	-256.3753	31.3097	-0.92	-250.9768
	4.72	29.6768	-0.5414	-254.6775	-1.343	-0.013	28.9305	-0.5317	-257.8976	30.4231	-0.5511	-251.4574
	4.736	29.6275	-0.0369	-255.9471	-1.3239	0.1129	28.9956	-0.1086	-258.471	30.2595	0.0347	-253.4232
	4.752	29.6702	0.1381	-256.4155	-1.3108	-0.6413	29.0001	0.6384	-259.5592	30.3403	-0.3621	-253.2717
	4.768	29.4242	1.4211	-258.457	-1.2551	-0.8416	28.6499	2.2877	-262.0153	30.1986	0.5544	-254.8987
	4.784	29.4844	1.2244	-259.0676	-1.1624	-0.6466	28.282	2.1321	-262.549	30.6868	0.3167	-255.5861
	4.8	29.5682	1.8343	-260.1447	-1.1578	-0.7098	28.4482	2.7965	-263.5147	30.6882	0.8721	-256.7747
	4.816	28.8816	1.891	-260.7202	-1.1229	-0.8772	27.8594	3.1204	-264.048	29.9038	0.6616	-257.3923
	4.832	29.3333	2.4673	-262.0353	-1.0888	-0.7585	28.0208	3.711	-265.4913	30.6458	1.2236	-258.5794
	4.848	28.9586	2.3707	-262.6451	-1.1494	-0.9078	27.9908	3.61	-266.1527	29.9264	1.1314	-259.1375
	4.864	29.1542	2.8144	-263.6242	-1.0697	-0.8775	27.964	4.2469	-267.0243	30.3445	1.3819	-260.224
	4.88	29.5858	3.143	-265.1455	-1.085	-0.7531	28.2604	4.3856	-268.586	30.9112	1.9005	-261.7051
	4.896	29.7811	2.9325	-265.947	-1.1165	-0.9689	28.8767	4.2489	-269.2173	30.6854	1.616	-262.6767
	4.912	30.0111	3.8591	-266.8934	-1.039	-1.0222	29.0069	5.502	-270.1664	31.0152	2.2162	-263.6205
	4.928	29.5133	3.4174	-267.3686	-1.0771	-1.1433	28.7172	5.165	-270.9369	30.3095	1.6698	-263.8004
	4.944	29.8796	4.2986	-268.9457	-1.1194	-1.243	29.3284	5.9197	-272.4775	30.4308	2.6775	-265.414
	4.96	29.2744	4.3862	-269.6043	-1.0651	-0.9824	28.143	6.082	-273.2862	30.4059	2.6903	-265.9225
	4.976	29.7453	4.6498	-271.0163	-1.1127	-1.021	28.877	6.0666	-274.3862	30.6135	3.2331	-267.6464
	4.992	29.9289	4.5606	-271.529	-1.0793	-0.9317	28.9053	5.9381	-274.7351	30.9526	3.1832	-268.3229
	5.008	30.1189	4.3931	-272.1616	-1.0633	-1.0965	29.2065	6.1704	-275.7544	31.0314	2.6158	-268.5688
	5.024	29.7117	4.5652	-272.9464	-1.0834	-1.0999	28.9807	6.0011	-275.9864	30.4427	3.1294	-269.9065
	5.04	30.2641	4.1706	-273.8512	-1.1813	-1.4307	30.0326	5.8117	-277.8887	30.4955	2.5294	-269.8137
	5.056	30.6877	4.4906	-275.1459	-1.1248	-1.5905	30.7208	6.1702	-278.6594	30.6546	2.8109	-271.6323
	5.072	31.4726	4.5186	-275.7465	-1.1321	-2.3259	32.5489	5.662	-279.0931	30.3963	3.3751	-272.3999
	5.088	32.4365	4.7147	-276.6321	-1.0044	-2.4474	34.0716	6.0759	-279.978	30.8014	3.3535	-273.2862
	5.104	32.2217	4.7786	-277.7365	-1.0206	-2.3379	33.8731	6.4915	-281.6155	30.5703	3.0657	-273.8576

Man9	v1= 3.48										
time	pos(x)	pos(y)	pos(z)	el	az	x1	y1	z1	x2	y2	z2
0	0	0	0	-0.4769	2.7128	2.2965	-1.0499	-1.3047	-2.2965	1.0499	1.3047
0.016	-0.0078	-0.9242	-7.1416	-0.6543	2.7707	2.0569	-1.7272	-8.841	-2.0725	-0.1212	-5.4423
0.032	0.0119	-0.7718	-11.1565	-0.9415	2.7453	1.5796	-1.4277	-13.4908	-1.5559	-0.1158	-8.8222
0.048	-1.2112	0.158	-14.5866	-1.0591	2.7897	0.1938	-0.3578	-17.2517	-2.6161	0.6738	-11.9215
0.064	-2.7169	1.0427	-16.8914	-1.2203	-2.8934	-1.77	1.2827	-19.563	-3.6638	0.8027	-14.2197
0.08	-4.2311	1.7088	-19.766	-1.3944	-1.4972	-4.2646	2.1637	-22.3252	-4.1975	1.2539	-17.2069
0.096	-5.1171	2.1738	-21.3481	-1.4064	-0.8115	-5.3834	2.4543	-23.6789	-4.8509	1.8933	-19.0174
0.112	-6.2063	2.5174	-22.6609	-0.9799	-0.5777	-7.2651	3.2076	-24.5448	-5.1475	1.8271	-20.777
0.128	-8.3089	3.1671	-23.3399	-0.5868	-0.5695	-9.7773	4.1073	-24.4994	-6.8405	2.2269	-22.1804
0.144	-10.8211	3.794	-23.6449	-0.397	-0.6598	-12.4432	5.0525	-24.5057	-9.199	2.5355	-22.784
0.16	-11.7923	4.7535	-23.4307	-0.448	-0.6767	-13.0941	5.7991	-24.2332	-10.4905	3.7079	-22.6282
0.176	-14.0625	5.5014	-24.5784	-0.6375	-0.3857	-15.6826	6.1592	-25.8735	-12.4424	4.8436	-23.2832
0.192	-14.1034	5.274	-26.1142	-0.4333	-0.4335	-16.2007	6.2446	-27.1835	-12.0061	4.3033	-25.045
0.208	-14.8198	6.3262	-27.819	-0.457	-0.4061	-16.9541	7.2439	-28.9615	-12.6855	5.4085	-26.6765
0.224	-16.5947	6.6929	-28.3095	-0.3338	-0.4848	-18.7598	7.8332	-29.1583	-14.4295	5.5525	-27.4608
0.24	-17.4182	6.7438	-28.9517	-0.5547	-0.4571	-19.1354	7.5884	-30.1375	-15.7009	5.8992	-27.766
0.256	-17.6243	6.0417	-30.0585	-0.4147	-0.4334	-19.8263	7.0606	-31.1268	-15.4222	5.0228	-28.9902
0.272	-18.1326	6.355	-30.4214	-0.5648	-0.3342	-20.1251	7.047	-31.7579	-16.14	5.6631	-29.085
0.288	-18.247	6.5297	-32.3369	-0.3358	-0.3829	-21.2195	7.727	-33.4555	-15.2745	5.3323	-31.2183
0.304	-17.7624	6.828	-33.0239	-0.3472	-0.5177	-19.8868	8.0377	-33.9086	-15.6381	5.6182	-32.1393
0.32	-17.5206	6.6858	-33.6769	-0.4785	-0.531	-19.5016	7.8492	-34.8686	-15.5397	5.5224	-32.4851
0.336	-17.2	7.0776	-33.835	-0.4354	-0.3707	-19.4627	7.9571	-34.9643	-14.9374	6.1981	-32.7056
0.352	-17.9071	7.2693	-35.1898	-0.3394	-0.1614	-21.0225	7.7766	-36.3044	-14.7916	6.762	-34.0753
0.368	-18.0099	6.681	-37.6011	-0.2372	-0.2601	-21.1505	7.5169	-38.3868	-14.8693	5.8451	-36.8153
0.384	-18.4223	6.6893	-38.5652	-0.3155	-0.2686	-21.3623	7.4986	-39.5607	-15.4824	5.8801	-37.5698
0.4	-18.6655	6.3318	-39.6613	-0.2022	-0.2524	-21.4163	7.0411	-40.2438	-15.9147	5.6224	-39.0788
0.416	-18.8248	6.5794	-40.6462	-0.393	-0.1541	-21.7249	7.0298	-41.8629	-15.9247	6.129	-39.4294
0.432	-19.3559	6.5226	-42.2801	-0.195	-0.2858	-22.019	7.3053	-42.8282	-16.6928	5.74	-41.7319
0.448	-19.7479	6.5503	-43.6813	-0.0683	-0.3475	-22.5865	7.5786	-43.8878	-16.9092	5.522	-43.4748
0.464	-20.4508	6.8188	-44.4949	-0.1243	0.0174	-23.0378	6.7739	-44.8182	-17.8639	6.8637	-44.1715
0.48	-21.0674	7.0607	-44.9026	-0.1597	0.1927	-23.4063	6.6043	-45.2865	-18.7285	7.517	-44.5188
0.496	-20.9417	6.6184	-47.314	0.0479	0.0794	-23.3041	6.4305	-47.2005	-18.5792	6.8064	-47.4276
0.512	-21.3277	7.031	-48.553	-0.0278	0.1435	-23.5487	6.71	-48.6154	-19.1067	7.352	-48.4907
0.528	-20.9171	6.293	-50.4283	0.3703	-0.1099	-23.363	6.563	-49.4731	-18.4712	6.0231	-51.3836
0.544	-20.1217	5.9181	-52.4616	0.4811	-0.0784	-22.2098	6.0821	-51.3682	-18.0336	5.754	-53.555
0.56	-20.0464	5.8083	-55.0954	1.0854	-0.3713	-20.8024	6.1026	-53.5573	-19.2904	5.5139	-56.6334
0.576	-20.7777	6.0264	-57.0092	1.1894	-0.433	-21.3996	6.3138	-55.3011	-20.1559	5.7389	-58.7173
0.592	-21.1122	6.817	-57.5836	1.3707	0.2123	-21.408	6.7532	-56.0912	-20.8163	6.8807	-59.076
0.608	-21.6834	6.7831	-59.0358	1.4611	-2.8286	-21.492	6.845	-57.2094	-21.8748	6.7212	-60.8622
0.624	-22.713	7.305	-60.6423	1.3154	-2.7494	-22.1967	7.0914	-58.5018	-23.2294	7.5185	-62.7828
0.64	-23.4468	8.3466	-60.3987	1.0708	2.3049	-22.7933	7.6223	-58.6129	-24.1003	9.0708	-62.1844
0.656	-24.0089	8.4395	-61.2354	0.9965	2.2561	-23.367	7.6542	-59.6676	-24.6509	9.2248	-62.8031
0.672	-24.5983	9.0206	-61.4826	0.8609	2.2976	-23.7714	8.0907	-60.0346	-25.4252	9.9505	-62.9306
0.688	-24.629	9.4026	-62.2053	1.0639	2.0746	-24.1651	8.5611	-60.4752	-25.0928	10.244	-63.9355
0.704	-25.3266	9.8502	-62.0136	0.4946	2.0262	-24.6738	8.5171	-61.2131	-25.9795	11.1832	-62.8141
0.72	-26.0309	10.1687	-62.5426	0.1801	2.1554	-25.1808	8.8841	-62.2621	-26.881	11.4534	-62.823
0.736	-26.3139	10.4737	-62.9762	0.1032	2.0289	-25.5991	9.0239	-62.8088	-27.0288	11.9235	-63.1437
0.752	-27.1406	10.4077	-63.6717	-0.1781	2.2554	-26.0121	9.0254	-63.9929	-28.2691	11.7901	-63.3506
0.768	-27.0136	10.775	-64.4899	-0.152	2.3212	-25.7746	9.4461	-64.7682	-28.2526	12.1038	-64.2117
0.784	-27.5812	10.8356	-65.3598	-0.2142	1.9114	-27.1481	9.6138	-65.6419	-28.0142	12.0574	-65.0778
0.8	-27.4004	10.545	-66.1745	-0.1999	1.704	-27.3166	9.9198	-66.3023	-27.4841	11.1701	-66.0467
0.816	-27.5672	10.9867	-66.9465	-0.4426	1.9943	-27.1263	10.0086	-67.4549	-28.0081	11.9648	-66.438
0.832	-27.748	11.7005	-67.5315	-0.535	1.8904	-27.2764	10.2756	-68.421	-28.2195	13.1254	-66.6419
0.848	-27.8818	11.4534	-68.9689	-0.4852	1.8897	-27.5217	10.3628	-69.5745	-28.2419	12.544	-68.3634
0.864	-27.9054	11.6558	-69.7812	-0.4858	1.8779	-27.581	10.6327	-70.3479	-28.2298	12.6789	-69.2145
0.88	-28.6648	11.9406	-70.8143	-0.5025	2.0763	-27.9501	10.6493	-71.6254	-29.3794	13.2318	-70.0032
0.896	-29.1406	12.3358	-72.0045	-0.4264	1.7457	-28.9182	11.0771	-72.5851	-29.3629	13.5944	-71.4238
0.912	-29.2235	12.6125	-73.1402	-0.3797	1.953	-28.6872	11.2786	-73.7139	-29.7597	13.9464	-72.5666
0.928	-29.7298	13.1399	-73.9846	-0.5988	1.9017	-29.3197	11.9459	-74.846	-30.14	14.3338	-73.1232
0.944	-30.2376	13.5072	-75.0507	-0.5461	1.8951	-29.7079	11.9314	-76.061	-30.7672	15.083	-74.0404
0.96	-30.4348	13.7779	-76.5611	-0.4833	1.8375	-30.0396	12.3314	-77.348	-30.83	15.2243	-75.7743
0.976	-30.3661	14.0641	-78.0377	-0.4179	1.9547	-29.6613	12.319	-78.8736	-31.071	15.8092	-77.2019
0.992	-30.9869	14.723	-79.3314	-0.4135	1.8984	-30.5009	13.2933	-79.994	-31.4728	16.1527	-78.6689
1.008	-31.3587	14.5997	-80.7609	-0.2454	1.8984	-30.9354	13.3542	-81.0904	-31.782	15.8453	-80.4315
1.024	-31.6119	15.35	-82.8833	0.072	1.9071	-31.1603	14.0583	-82.7846	-32.0636	16.6416	-82.9819
1.04	-31.5682	15.5283	-83.9768	0.0328	1.8904	-31.1031	14.1228	-83.9282	-32.0332	16.9337	-84.0254

Man9	time	pos(x)	pos(y)	pos(z)	el	az	x1	y1	z1	x2	y2	z2
	1.056	-31.7728	15.986	-85.7917	0.6175	1.7707	-31.5169	14.7232	-84.8767	-32.0286	17.2488	-86.7067
	1.072	-32.2359	15.8885	-86.913	0.3914	2.1167	-31.5661	14.7859	-86.3807	-32.9056	16.991	-87.4454
	1.088	-32.9191	16.8405	-88.5454	0.5485	2.0002	-32.284	15.4534	-87.6132	-33.5541	18.2275	-89.4776
	1.104	-33.0813	16.5629	-89.9	0.662	2.0489	-32.2859	15.028	-88.5528	-33.8768	18.0978	-91.2471
	1.12	-33.4255	17.2593	-91.7908	0.525	2.1614	-32.1543	15.3632	-90.4685	-34.6968	19.1553	-93.1131
	1.136	-33.8689	17.5482	-93.168	0.8562	2.0699	-33.0577	16.0603	-91.2145	-34.68	19.036	-95.1215
	1.152	-33.6643	17.1277	-94.478	1.0781	1.9303	-33.2497	16.0245	-92.2824	-34.0789	18.2309	-96.6735
	1.168	-32.6264	16.7348	-96.416	1.3332	1.1854	-32.8665	16.143	-93.7783	-32.3863	17.3265	-99.0536
	1.184	-33.4214	16.6448	-96.7207	1.3412	1.5067	-33.4618	16.0143	-94.0177	-33.3809	17.2752	-99.4237
	1.2	-32.9068	16.3213	-97.4423	1.4015	1.0821	-33.0858	15.9847	-95.2118	-32.7278	16.658	-99.6728
	1.216	-31.8486	15.9219	-97.5696	1.1524	-0.4537	-32.8191	16.3951	-95.1414	-30.878	15.4486	-99.9979
	1.232	-32.0629	15.8611	-98.5549	0.9861	-0.5936	-33.5332	16.8533	-95.8748	-30.5925	14.8688	-101.2351
	1.248	-32.0434	15.9569	-99.0319	0.8665	-0.4047	-33.8845	16.7455	-96.6746	-30.2023	15.1684	-101.3891
	1.264	-31.7103	15.7832	-99.4599	0.8027	-0.5197	-33.1908	16.6302	-97.6942	-30.2298	14.9361	-101.2255
	1.28	-31.5176	15.6223	-100.5797	0.6571	-0.2903	-33.6255	16.252	-98.8825	-29.4097	14.9925	-102.2768
	1.296	-31.9863	14.9749	-101.2877	0.6386	-0.4944	-34.1361	16.1338	-99.4746	-29.8364	13.8159	-103.1009
	1.312	-32.0733	15.3967	-101.9617	0.6318	-0.3346	-34.2507	16.1537	-100.2747	-29.8959	14.6396	-103.6487
	1.328	-31.8413	14.3031	-103.2676	0.4743	-0.4829	-34.2593	15.5709	-101.8659	-29.4233	13.0352	-104.6693
	1.344	-32.2831	14.2353	-104.7433	0.5259	-0.5971	-34.7198	15.8919	-103.0332	-29.8464	12.5787	-106.4534
	1.36	-32.2613	14.0625	-105.694	0.6093	-0.603	-34.0995	15.3282	-104.1365	-30.4231	12.7969	-107.2515
	1.376	-31.7358	14.1285	-107.1914	0.5145	-0.9366	-33.3344	16.3021	-105.6662	-30.1371	11.955	-108.7166
	1.392	-32.0209	14.6174	-108.784	0.5814	-0.7275	-33.8458	16.2425	-107.1783	-30.1961	12.9924	-110.3897
	1.408	-32.3625	14.4522	-109.3659	0.4417	-0.9132	-33.9222	16.4717	-108.1595	-30.8028	12.4326	-110.5724
	1.424	-31.7631	14.6017	-110.9942	0.4337	-0.8457	-33.3487	16.3912	-109.887	-30.1774	12.8122	-112.1014
	1.44	-31.2844	14.3068	-112.3305	0.3602	-0.8848	-33.0784	16.4982	-111.2638	-29.4903	12.1154	-113.3972
	1.456	-31.7913	14.6544	-114.1646	0.3719	-0.7617	-33.7505	16.523	-113.1085	-29.832	12.7857	-115.2207
	1.472	-32.0148	14.2859	-115.8033	0.435	-0.9039	-33.9461	16.7389	-114.3525	-30.0836	11.8329	-117.254
	1.488	-31.9562	14.2935	-117.1263	0.5677	-0.8801	-33.5777	16.2551	-115.5033	-30.3347	12.3318	-118.7492
	1.504	-32.0734	14.4409	-118.564	0.679	-0.9832	-33.2579	16.2191	-116.8397	-30.8889	12.6627	-120.2883
	1.52	-31.7878	14.5022	-120.0495	0.5487	-0.8707	-33.5807	16.6303	-118.3485	-29.995	12.3742	-121.7505
	1.536	-31.9205	14.4302	-121.9454	0.7112	-0.9062	-33.3153	16.2102	-119.997	-30.5258	12.6501	-123.8937
	1.552	-31.7595	14.478	-123.8405	0.5931	-0.8119	-33.6567	16.4785	-121.982	-29.8623	12.4776	-125.699
	1.568	-32.5268	15.2131	-125.0288	0.8035	-0.9525	-33.5924	16.7112	-123.1227	-31.4611	13.7151	-126.9349
	1.584	-33.1851	15.0344	-127.1079	0.6797	-0.7754	-35.1506	16.9608	-124.8835	-31.2196	13.1079	-129.3322
	1.6	-32.29	14.9157	-129.3059	0.8393	-0.6838	-33.9465	16.2659	-126.9252	-30.6335	13.5656	-131.6865
	1.616	-33.2227	14.9109	-130.579	1.2586	-1.1795	-33.4898	15.5584	-128.409	-32.9556	14.2635	-132.749
	1.632	-34.5956	16.0297	-132.0502	1.1665	-0.4727	-35.6657	16.577	-129.2414	-33.5256	15.4825	-134.859
	1.648	-35.0409	16.7844	-133.8286	1.4049	0.6308	-35.4548	16.4821	-130.7673	-34.6271	17.0866	-136.8898
	1.664	-35.9746	17.6012	-135.4106	1.2148	2.3824	-35.3167	16.9769	-132.9711	-36.6325	18.2255	-137.8502
	1.68	-36.8636	17.6646	-136.0842	1.0345	2.3948	-35.8732	16.748	-133.8138	-37.8539	18.5812	-138.3546
	1.696	-38.0519	18.9182	-136.6584	0.8226	2.3512	-36.6768	17.5291	-134.5525	-39.4271	20.3072	-138.7643
	1.712	-38.9886	19.5804	-137.3578	0.5324	2.3573	-37.1926	17.7883	-135.863	-40.7847	21.3724	-138.8526
	1.728	-39.3675	19.7938	-137.7689	0.3816	2.227	-37.9553	17.9598	-136.8401	-40.7797	21.6277	-138.6977
	1.744	-39.1454	20.4402	-138.7886	0.3979	2.1131	-38.0716	18.6584	-137.9143	-40.2191	22.2221	-139.663
	1.76	-39.3703	20.8812	-138.9378	0.2175	2.026	-38.4192	18.9383	-138.4598	-40.3214	22.8241	-139.4158
	1.776	-39.5126	21.1945	-139.1313	0.0787	2.1035	-38.2593	19.0687	-138.9367	-40.7659	23.3203	-139.326
	1.792	-39.3929	21.4088	-139.918	0.1375	1.9374	-38.4689	19.0026	-139.5614	-40.3168	23.815	-140.2745
	1.808	-39.2203	20.8937	-141.3071	0.3859	2.0662	-38.4712	19.5074	-140.6668	-39.9694	22.2801	-141.9474
	1.824	-39.3873	20.6191	-141.8538	0.1864	2.1552	-38.7398	19.6403	-141.6325	-40.0348	21.5979	-142.0751
	1.84	-39.5766	21.163	-142.8235	0.214	2.0751	-39.0495	20.208	-142.5864	-40.1036	22.1181	-143.0606
	1.856	-39.4121	21.4158	-143.2407	-0.4009	1.3488	-39.6886	20.191	-143.773	-39.1356	22.6405	-142.7085
	1.872	-39.673	21.3725	-145.1587	-0.1474	1.261	-39.9293	20.5721	-145.2835	-39.4168	22.173	-145.0339
	1.888	-41.2252	21.6397	-145.4495	-0.9324	2.2391	-40.664	20.9289	-146.6699	-41.7864	22.3506	-144.2291
	1.904	-40.8436	21.9247	-147.0715	-0.8568	2.1043	-40.2933	20.993	-148.3203	-41.394	22.8565	-145.8226
	1.92	-41.6958	22.0373	-148.4282	-0.8789	2.0108	-41.2335	21.0553	-149.7382	-42.158	23.0193	-147.1183
	1.936	-41.4177	22.3009	-149.513	-0.971	2.0371	-40.9839	21.4391	-150.924	-41.8515	23.1628	-148.1019
	1.952	-42.2625	22.8554	-150.8302	-0.7845	2.2663	-41.434	21.8629	-152.1207	-43.0909	23.848	-149.5398
	1.968	-42.5651	23.7236	-152.682	-0.8644	1.8047	-42.3825	22.9574	-153.6051	-42.7476	24.4899	-151.759
	1.984	-42.7049	23.981	-154.0501	-0.7274	2.0368	-42.2427	23.0622	-154.9658	-43.167	24.8999	-153.1345
	2	-43.2157	24.2813	-155.3789	-0.8232	2.1779	-42.7004	23.5395	-156.3531	-43.7309	25.023	-154.4047
	2.016	-43.6411	24.6708	-156.7846	-0.7344	2.1302	-43.0405	23.7115	-157.8065	-44.2418	25.6302	-155.7627
	2.032	-43.9742	25.5606	-158.2442	-0.7733	2.2208	-43.2527	24.6115	-159.4078	-44.6957	26.5097	-157.0806
	2.048	-44.4515	25.7653	-159.975	-0.9271	2.2544	-44.0433	25.2641	-160.8366	-44.8598	26.2664	-159.1135
	2.064	-45.3097	26.2032	-162.7407	0.3035	2.0981	-44.7902	25.311	-162.4173	-45.8292	27.0953	-163.064
	2.08	-45.3438	26.7227	-164.6603	0.4842	1.8443	-45.1441	26.0109	-164.2715	-45.5435	27.4345	-165.0492
	2.096	-45.9951	27.5997	-165.9098	0.5311	2.114	-45.501	26.7813	-165.3483	-46.4892	28.418	-166.4712

Man9	time	pos(x)	pos(y)	pos(z)	el	az	x1	y1	z1	x2	y2	z2
	2.112	-46.5539	28.1387	-168.5951	0.5348	2.2365	-45.6661	27.0082	-167.7437	-47.4416	29.2693	-169.4465
	2.128	-46.6859	27.8673	-170.3322	0.7488	2.4363	-45.6888	27.0184	-169.1153	-47.683	28.7163	-171.5492
	2.144	-47.3833	28.2718	-172.0546	0.6647	2.5164	-46.1063	27.3501	-170.8206	-48.6603	29.1935	-173.2887
	2.16	-47.7866	28.5686	-173.6044	0.6787	2.4088	-46.3151	27.2445	-172.008	-49.2581	29.8928	-175.2008
	2.176	-46.865	27.8307	-175.2696	1.0693	2.246	-46.2633	27.0793	-173.514	-47.4666	28.582	-177.0252
	2.192	-47.6926	28.2519	-177.4004	1.0715	2.2701	-46.8087	27.2011	-174.8829	-48.5765	29.3028	-179.9179
	2.208	-46.252	27.644	-179.1676	1.4068	0.0744	-46.7794	27.6047	-175.9725	-45.7246	27.6833	-182.3627
	2.224	-46.5733	27.2698	-180.3525	1.5453	0.6154	-46.6309	27.229	-177.5873	-46.5157	27.3105	-183.1177
	2.24	-46.3342	26.963	-181.1586	1.0806	-0.5888	-47.6304	27.8287	-178.2375	-45.0379	26.0972	-184.0798
	2.256	-45.2198	26.2725	-182.1049	0.8393	-0.559	-47.2844	27.564	-179.3917	-43.1552	24.9809	-184.8181
	2.272	-44.9273	26.1158	-182.2498	0.6451	-0.6257	-47.4672	27.9509	-179.8915	-42.3873	24.2806	-184.608
	2.288	-44.5822	26.0592	-183.1695	0.4583	-0.7445	-47.6974	28.9295	-181.0799	-41.4671	23.1889	-185.259
	2.304	-44.7339	26.6287	-184.2354	0.3465	-0.7485	-48.0962	29.7516	-182.5785	-41.3715	23.5058	-185.8923
	2.32	-45.3528	26.4843	-185.4437	0.2465	-0.6459	-50.6495	30.4763	-183.7751	-40.0561	22.4922	-187.1123
	2.336	-44.4247	26.5786	-186.1165	0.1998	-0.663	-48.7126	29.9268	-185.0147	-40.1369	23.2304	-187.2183
	2.352	-44.2039	25.8066	-186.9847	0.2081	-0.6564	-48.2661	28.9362	-185.902	-40.1418	22.6771	-188.0675
	2.368	-45.1143	25.9913	-188.3804	0.1754	-0.6453	-48.9999	28.9165	-187.5183	-41.2288	23.066	-189.2424
	2.384	-44.8715	24.8568	-188.9518	0.1731	-0.6452	-49.4277	28.2862	-187.9546	-40.3153	21.4274	-189.949
	2.4	-44.2996	25.0697	-190.3207	0.1436	-0.6635	-49.2879	28.9694	-189.4054	-39.3113	21.17	-191.2359
	2.416	-43.9192	24.1924	-191.3515	0.13	-0.6392	-48.7447	27.779	-190.5654	-39.0937	20.6058	-192.1377
	2.432	-44.2362	24.4192	-192.7384	0.1948	-0.6844	-48.2455	27.6908	-191.7175	-40.2268	21.1477	-193.7593
	2.448	-44.9851	25.2885	-194.1587	0.175	-0.6942	-48.9077	28.5536	-193.2562	-41.0624	22.0234	-195.0612
	2.464	-44.0354	24.6664	-195.8867	0.1557	-0.6568	-48.4686	28.0844	-195.0078	-39.6021	21.2484	-196.7655
	2.48	-45.1369	24.6668	-196.4433	0.2114	-0.6022	-50.5421	28.3822	-195.0358	-39.7317	20.9513	-197.8508
	2.496	-44.8792	24.6234	-198.6616	0.3012	-0.6344	-49.7702	28.2225	-196.7751	-39.9882	21.0244	-200.5481
	2.512	-44.274	23.5312	-200.1947	0.2304	-0.7341	-48.7628	27.5815	-198.7768	-39.7853	19.4808	-201.6127
	2.528	-43.6799	23.2558	-202.174	0.2549	-0.817	-47.44	27.2613	-200.7422	-39.9198	19.2503	-203.6058
	2.544	-43.666	23.2531	-203.2304	0.2899	-0.7823	-47.22	26.7853	-201.7358	-40.1119	19.7209	-204.7251
	2.56	-44.1467	24.2588	-205.6749	0.3726	-0.6939	-47.3217	26.9004	-204.0606	-40.9717	21.6172	-207.2893
	2.576	-44.0329	24.0487	-206.7447	0.5383	-0.6462	-47.3796	26.5728	-204.2416	-40.6862	21.5247	-209.2479
	2.592	-43.7315	23.8871	-208.549	0.6167	-0.711	-46.2266	26.0359	-206.2148	-41.2365	21.7383	-210.8833
	2.608	-44.1448	23.7318	-210.0088	0.4771	-0.7366	-47.0927	26.4054	-207.9514	-41.1969	21.0582	-212.0662
	2.624	-42.9247	23.1949	-211.335	0.7595	-0.705	-44.9594	24.926	-208.7986	-40.89	21.4637	-213.8715
	2.64	-44.8101	24.1465	-213.6158	1.4195	-2.2627	-44.5459	24.4655	-210.9	-45.0744	23.8276	-216.3316
	2.656	-43.7431	23.0216	-215.5148	1.3968	-1.3257	-43.8817	23.5756	-212.2648	-43.6045	22.4675	-218.7648
	2.672	-44.2574	23.2797	-215.9249	1.4796	-1.2549	-44.3344	23.5153	-213.2135	-44.1804	23.0441	-218.6362
	2.688	-45.0431	24.3702	-216.9656	1.276	2.3614	-44.4324	23.7658	-214.1358	-45.6538	24.9747	-219.7954
	2.704	-45.4217	24.6513	-218.8044	0.9979	2.407	-44.0479	23.4104	-215.9346	-46.7955	25.8923	-221.6741
	2.72	-45.9236	25.5471	-219.3878	0.9008	2.1105	-45.0432	24.0774	-217.2254	-46.804	27.0168	-221.5503
	2.736	-46.0669	25.4003	-220.3284	0.8638	1.983	-45.3733	23.814	-218.3018	-46.7606	26.9866	-222.355
	2.752	-45.965	25.7345	-221.5546	0.7582	2.0943	-45.0275	24.1103	-219.7785	-46.9025	27.3586	-223.3306
	2.768	-46.1002	25.5972	-221.2982	0.6894	2.0847	-45.3259	24.2256	-219.9998	-46.8744	26.9688	-222.5965
	2.784	-46.3466	25.452	-222.7317	1.3759	1.9933	-46.2355	25.2051	-221.3599	-46.4576	25.6989	-224.1036
	2.8	-45.8242	24.9625	-222.8206	0.5549	1.9395	-45.529	24.1982	-222.3127	-46.1195	25.7267	-223.3285
	2.816	-46.4788	25.8727	-223.7342	0.3013	1.9588	-46.1009	24.9482	-223.4238	-46.8567	26.7972	-224.0445
	2.832	-46.4484	25.8268	-224.9455	0.2372	1.9276	-46.1743	25.0916	-224.7559	-46.7225	26.562	-225.1352
	2.848	-46.549	25.9708	-225.6484	-0.0105	1.9539	-46.2709	25.2809	-225.6562	-46.827	26.6606	-225.6406
	2.864	-47.0142	26.5613	-227.4512	0.3346	1.7932	-46.7154	25.2403	-226.9803	-47.3129	27.8823	-227.9221
	2.88	-46.3475	26.1793	-228.4966	0.3404	1.2424	-46.5864	25.4784	-228.2344	-46.1087	26.8803	-228.7589
	2.896	-46.352	26.5269	-230.0849	0.1815	1.7666	-46.1705	25.6122	-229.9138	-46.5334	27.4417	-230.256
	2.912	-46.5438	26.5094	-230.1334	-0.3595	2.4531	-44.0751	24.4782	-231.3349	-49.0125	28.5407	-228.9319
	2.928	-47.2351	26.8216	-231.9561	-0.4563	2.5572	-44.4755	24.9963	-233.58	-49.9947	28.6469	-230.3322
	2.944	-49.5136	27.7368	-233.101	-0.4195	2.5877	-46.591	25.9293	-234.6334	-52.4363	29.5444	-231.5685
	2.96	-49.3219	27.6312	-234.2207	-0.3228	2.6402	-45.7119	25.6524	-235.5978	-52.9319	29.6101	-232.8435
	2.976	-50.089	28.5194	-235.5325	-0.3697	2.6181	-46.5212	26.4601	-237.129	-53.6569	30.5787	-233.9361
	2.992	-50.29	28.1076	-236.9839	-0.3018	2.5604	-46.3476	25.5178	-238.4526	-54.2325	30.6973	-235.5152
	3.008	-51.9589	28.8746	-238.7516	-0.4144	2.603	-47.9066	26.4534	-240.8282	-56.0113	31.2958	-236.6751
	3.024	-51.3873	29.7186	-240.3887	-0.3859	2.5712	-47.5305	27.2443	-242.25	-55.244	32.1929	-238.5273
	3.04	-52.55	30.2667	-242.2789	-0.4669	2.5189	-49.2052	27.8651	-244.3547	-55.8948	32.6682	-240.2031
	3.056	-51.8114	29.5394	-243.7586	-0.4628	2.6841	-47.8582	27.5934	-245.9568	-55.7645	31.4854	-241.5604
	3.072	-53.1523	30.4456	-245.1259	-0.5371	2.6838	-49.8507	28.8189	-247.3178	-56.4539	32.0724	-242.9341
	3.088	-54.3575	30.6618	-246.8343	-0.5038	2.6379	-51.0056	28.8145	-248.9439	-57.7095	32.5091	-244.7246
	3.104	-54.2894	30.6136	-248.3802	-0.557	2.6878	-51.0758	29.0463	-250.6067	-57.503	32.1809	-246.1537
	3.12	-55.6458	31.6716	-250.5164	-0.4416	2.6276	-51.6356	29.4073	-252.6936	-59.6559	33.936	-248.3393
	3.136	-55.6865	31.9107	-252.1092	-0.5975	2.5561	-52.9003	30.0634	-254.3839	-58.4727	33.7579	-249.8345
	3.152	-56.9136	31.9832	-253.8033	-0.5194	2.6143	-53.5505	30.0252	-256.0281	-60.2766	33.9413	-251.5785

Man9											
time	pos(x)	pos(y)	pos(z)	el	az	x1	y1	z1	x2	y2	z2
3.168	-58.07	32.4018	-254.6644	-0.4672	2.6303	-53.9904	30.1128	-257.0244	-62.1497	34.6909	-252.3044
3.184	-58.5702	32.1789	-256.3345	-0.3573	2.643	-54.0471	29.7161	-258.2572	-63.0933	34.6417	-254.4117
3.2	-59.5188	33.4176	-258.7193	-0.447	2.6726	-55.2691	31.2642	-261.0028	-63.7684	35.5711	-256.4358
3.216	-61.3885	35.0726	-261.238	-0.1423	2.5437	-56.5089	31.7494	-262.0839	-66.2681	38.3957	-260.392
3.232	-61.624	34.9639	-263.4101	-0.2225	2.6151	-56.5559	32.0185	-264.7363	-66.6921	37.9093	-262.084
3.248	-62.6964	35.4401	-264.9716	-0.1577	2.6468	-56.8027	32.2604	-266.0367	-68.5902	38.6199	-263.9064
3.264	-63.9247	36.0889	-266.7641	-0.1002	2.5839	-58.6158	32.7779	-267.3932	-69.2337	39.3999	-266.1351
3.28	-64.7944	35.9795	-269.0094	-0.169	2.652	-60.2459	33.5556	-269.8887	-69.3429	38.4034	-268.1302
3.296	-65.1635	36.0125	-271.6338	-0.0749	2.6667	-60.3134	33.5191	-272.0431	-70.0136	38.5059	-271.2244
3.312	-66.0642	35.7558	-273.5379	-0.0055	2.707	-60.6708	33.2522	-273.5709	-71.4576	38.2593	-273.505
3.328	-64.8163	34.7488	-275.7558	0.1458	2.8259	-61.0649	33.5235	-275.1764	-68.5678	35.9741	-276.3352
3.344	-65.7648	35.0408	-277.8521	0.2828	2.8456	-62.2475	33.9682	-276.7837	-69.2821	36.1133	-278.9206
3.36	-65.9785	34.8488	-279.96	0.5063	2.9241	-63.0746	34.2071	-278.3108	-68.8823	35.4904	-281.6092
3.376	-66.0718	34.6301	-281.988	0.6595	2.971	-63.5059	34.1882	-279.9693	-68.6378	35.072	-280.068
3.392	-65.049	33.9516	-283.6793	1.0611	2.8332	-63.8366	33.5655	-281.4026	-66.2614	34.3378	-285.9559
3.408	-64.6277	34.0513	-285.5536	1.2956	2.8842	-63.9464	33.872	-283.0592	-65.3089	34.2306	-288.048
3.424	-63.615	33.3302	-287.0196	1.3319	-1.8454	-63.4469	33.9269	-284.4744	-63.783	32.7336	-289.5648
3.44	-63.0935	32.8578	-288.0991	1.4475	-1.102	-63.2541	33.175	-285.2292	-62.9329	32.5406	-290.9689
3.456	-61.8624	32.0636	-290.0658	1.1619	-0.8853	-62.6645	33.0445	-287.1411	-61.0602	31.0826	-292.9904
3.472	-61.0555	31.3266	-290.4996	1.0718	-0.6959	-62.2451	32.3202	-287.6553	-59.8658	30.333	-293.3439
3.488	-58.5468	30.8001	-291.1432	0.7179	-0.4355	-61.022	31.9517	-288.7587	-56.0716	29.6485	-293.5276
3.504	-59.1042	30.4305	-292.2024	0.8068	-0.453	-61.2388	31.4695	-289.7246	-56.9696	29.3915	-294.6802
3.52	-59.141	30.2877	-292.1415	0.6247	-0.5805	-61.3895	31.7624	-290.2026	-56.8925	28.813	-294.0804

Manta 10											
time	pos(x)	pos(y)	pos(z)	el	az	x1	y1	z1	x2	y2	z2
0	0	0	0	-0.0608	0.2022	-2.9455	-0.604	-0.1832	2.9455	0.604	0.1832
0.016	-0.0982	0.0567	-3.757	0.0832	0.126	-3.337	-0.3534	-3.4847	3.1407	0.4669	-4.0293
0.032	0.477	0.753	-7.2485	0.2566	0.1653	-2.5768	0.2435	-6.436	3.5308	1.2624	-8.061
0.048	-0.6228	1.3251	-11.0675	0.2892	0.5088	-2.6674	0.1847	-10.3707	1.4218	2.4655	-11.7642
0.064	0.1704	1.8597	-13.7805	0.8928	0.345	-1.3775	1.3034	-11.7381	1.7182	2.416	-15.823
0.08	-0.6789	2.1438	-16.7336	1.2807	1.0173	-0.9951	1.6321	-14.7182	-0.3627	2.6556	-18.7489
0.096	-1.3779	2.6233	-20.2562	1.2498	2.4296	-0.7755	2.1035	-17.8629	-1.9802	3.1431	-22.6495
0.112	-2.4287	3.512	-21.0959	0.6246	2.8646	-0.2921	2.9045	-19.4947	-4.5652	4.1195	-22.6971
0.128	-2.8424	3.3704	-23.9519	0.5564	2.965	-0.5571	2.9626	-22.5079	-5.1278	3.7782	-25.3959
0.144	-3.0031	3.2135	-25.873	0.7415	3.0331	-1.1589	3.0126	-24.1739	-4.8473	3.4144	-27.5721
0.16	-2.435	3.1645	-28.1913	0.6424	3.1318	-0.3527	3.144	-26.6332	-4.5173	3.1849	-29.7494
0.176	-2.4406	2.9096	-30.9702	0.5711	2.9689	-0.2204	2.5225	-29.5223	-4.6608	3.2968	-32.4182
0.192	-2.4577	3.2892	-31.2843	0.5779	3.0467	-0.1627	3.0709	-29.7808	-4.7526	3.5076	-32.7879
0.208	-2.7169	3.1173	-33.5483	0.5033	2.9261	-0.6418	2.6632	-32.3788	-4.7921	3.5715	-34.7179
0.224	-2.2746	4.5547	-32.969	0.6346	2.6578	-0.6029	3.6764	-31.5788	-3.9463	5.4331	-34.3592
0.24	-2.0894	4.7219	-34.1424	0.8191	2.7987	-0.6009	4.1906	-32.4517	-3.5779	5.2533	-35.833
0.256	-2.2811	5.1778	-35.4739	0.9879	2.5762	-1.0887	4.4211	-33.332	-3.4735	5.9344	-37.6158
0.272	-1.3062	4.7913	-37.0324	1.2226	2.2003	-0.8152	4.1172	-34.735	-1.7972	5.4654	-39.3299
0.288	0.133	5.4978	-37.5805	1.0565	1.2883	-0.2005	4.3489	-35.4634	0.4664	6.6467	-39.6976
0.304	0.4962	5.3993	-38.2896	1.0086	0.9474	-0.1438	4.5093	-36.5497	1.1362	6.2892	-40.0295
0.32	0.7747	5.689	-38.8982	0.8648	0.4518	-0.6663	4.9897	-37.0197	2.2156	6.3882	-40.7767
0.336	2.1108	5.764	-39.5981	0.6437	0.368	0.3974	5.1033	-38.2202	3.8242	6.4246	-40.976
0.352	3.3161	5.4795	-39.8645	0.5424	0.3596	1.1537	4.6665	-38.4721	5.4784	6.2926	-41.2569
0.368	3.521	6.4024	-40.082	0.3645	0.4071	1.3859	5.4819	-39.195	5.656	7.3229	-40.969
0.384	4.0637	6.1835	-40.8464	0.5115	0.2686	1.7348	5.5424	-39.4904	6.3926	6.8247	-42.2024
0.4	4.3208	6.4502	-41.1576	0.409	0.2658	1.7659	5.7545	-40.01	6.8757	7.1458	-42.3052
0.416	4.8644	6.3406	-41.8582	0.3149	0.2048	2.0645	5.7591	-40.9267	7.6642	6.9222	-42.7898
0.432	4.6549	6.3582	-42.7352	0.4317	0.1888	1.8772	5.8275	-41.4325	7.4326	6.8888	-44.0378
0.448	5.3964	6.764	-43.2498	0.2546	0.1333	2.3472	6.3552	-42.4491	8.4456	7.1729	-44.0504
0.464	5.8787	7.0189	-43.1558	0.3312	0.1387	2.9736	6.6133	-42.1471	8.7839	7.4245	-44.1644
0.48	6.6957	6.5222	-44.4788	0.3310	-0.0964	3.4366	6.8374	-43.3537	9.9547	6.207	-45.6039
0.496	6.3984	5.79	-46.0595	0.1382	0.2576	3.5763	5.0466	-45.6535	9.2204	6.5335	-46.4655
0.512	6.6336	6.261	-46.5543	0.0951	0.1868	3.375	5.6451	-46.2379	9.8923	6.8769	-46.8706
0.528	6.8801	6.5316	-47.5933	0.2162	0.2056	3.7665	5.8822	-46.8946	9.9936	7.181	-48.292
0.544	6.8808	6.6922	-48.8409	0.2267	0.2597	4.0615	5.9431	-48.1679	9.7001	7.4414	-49.5139
0.56	6.5624	6.7581	-49.4989	0.31	0.2577	3.8187	6.035	-48.5899	9.3062	7.4813	-50.4079
0.576	6.3469	7.682	-50.1884	0.2318	0.422	3.6126	6.4543	-49.4811	9.0812	8.9097	-50.8958
0.592	6.6011	7.3593	-51.261	0.3078	0.2463	3.3589	6.5441	-50.1984	9.8432	8.1744	-52.3236
0.608	6.1371	7.4308	-52.7085	0.3503	0.4059	3.3215	6.2207	-51.5886	8.9528	8.6409	-53.8283

Ma10	time	pos(x)	pos(y)	pos(z)	el	az	x1	y1	z1	x2	y2	z2
	0.624	5.8104	7.7069	-53.8359	0.4458	0.4448	3.6045	6.6555	-52.6682	8.0163	8.7582	-55.0037
	0.64	6.0394	7.7491	-55.0578	0.4182	0.275	3.6465	7.074	-53.9529	8.4324	8.4242	-56.1626
	0.656	5.6702	8.431	-55.5878	0.5243	0.5186	3.5027	7.1938	-54.1446	7.8377	9.6681	-57.031
	0.672	5.7615	8.3721	-56.637	0.7509	0.2688	3.8731	7.8519	-54.809	7.6499	8.8923	-58.4649
	0.688	5.3408	8.6031	-57.7939	0.6977	0.304	3.189	7.928	-55.903	7.4926	9.2782	-59.6848
	0.704	5.5246	8.6286	-59.204	0.687	0.4686	3.5243	7.6159	-57.3646	7.5249	9.6412	-60.0433
	0.72	5.1126	9.2418	-60.2693	1	0.3394	3.6757	8.7345	-57.8965	6.5494	9.749	-62.6421
	0.736	4.2965	9.7546	-61.2163	1.0315	0.4346	2.997	9.1513	-58.8222	5.5961	10.3578	-63.6105
	0.752	3.4361	9.8566	-62.131	1.1206	1.2203	3.0546	8.8129	-59.8315	3.8177	10.9002	-64.4305
	0.768	2.6722	10.138	-63.175	1.3216	1.5302	2.6458	9.4878	-60.6179	2.6986	10.7882	-65.7321
	0.784	2.2825	9.5017	-65.777	1.3094	1.3356	2.1108	8.7853	-63.0227	2.4542	10.2182	-68.5313
	0.8	2.2921	9.2817	-67.28	1.4423	2.49	2.6443	9.013	-63.8528	1.9399	9.5503	-70.7071
	0.816	0.8425	10.0779	-67.2595	1.2728	2.1811	1.3821	9.3064	-64.1938	0.3029	10.8494	-70.3252
	0.832	0.8324	9.7706	-68.4943	1.0851	2.6053	1.9553	9.1031	-66.0195	-0.2905	10.438	-70.969
	0.848	-0.1508	10.0837	-69.9128	0.9465	2.6083	1.4211	9.1557	-67.3789	-1.7227	11.0116	-72.4467
	0.864	-0.634	9.9505	-70.3626	0.7577	2.7222	1.4483	9.0222	-68.2059	-2.7162	10.8789	-72.5193
	0.88	-1.3896	9.967	-71.4395	0.6443	2.8785	1.1273	9.289	-69.4811	-3.9066	10.645	-73.3979
	0.896	-2.0201	9.4783	-72.4503	0.625	2.7471	0.261	8.5285	-70.6675	-4.3012	10.428	-74.233
	0.912	-2.3993	9.2966	-73.4731	0.7379	2.9282	0.0025	8.7761	-71.2384	-4.8011	9.8172	-75.7078
	0.928	-2.3631	9.9892	-74.3122	0.551	2.943	0.8514	9.3422	-72.2974	-5.5775	10.6363	-76.3269
	0.944	-3.1459	10.0721	-74.9923	0.4886	2.7847	-0.0775	8.928	-73.2517	-6.2142	11.2162	-76.7329
	0.96	-3.3235	10.014	-75.9098	0.432	2.9601	-0.0939	9.4212	-74.3961	-6.553	10.6068	-77.4236
	0.976	-3.9667	9.7253	-76.6833	0.2965	3.0588	-0.1824	9.4114	-75.5231	-7.751	10.0393	-78.8435
	0.992	-4.142	9.8047	-77.3617	0.316	3.0656	0.2169	9.4726	-75.9323	-8.5009	10.1367	-78.7911
	1.008	-4.3579	9.6337	-78.628	0.2104	-3.1324	-0.0282	9.6736	-77.7032	-8.6876	9.5938	-79.5529
	1.024	-5.201	9.6733	-79.2734	0.1529	3.134	-1.154	9.6428	-78.6497	-9.248	9.7039	-79.897
	1.04	-5.2384	9.9958	-80.6631	0.1817	3.0973	-0.9557	9.8059	-79.8756	-9.5211	10.1857	-81.4505
	1.056	-5.5468	10.3886	-81.977	0.1202	-3.106	-1.5566	10.5306	-81.4949	-9.5369	10.2466	-82.4592
	1.072	-6	10.599	-83.5881	0.0864	-3.1121	-1.87	10.7208	-83.23	-10.1299	10.4772	-83.9462
	1.088	-6.364	10.4172	-84.4145	0.1982	-3.0557	-2.3548	10.7626	-83.6062	-10.3733	10.0719	-85.2228
	1.104	-6.8934	10.382	-85.1246	0.0537	-3.068	-2.5598	10.7015	-84.891	-11.227	10.0625	-85.3581
	1.12	-6.6351	10.7605	-86.3936	0.1005	-3.1364	-2.6341	10.7814	-85.99	-10.6361	10.7395	-86.7972
	1.136	-8.3139	10.9625	-87.7831	0.0197	-3.0762	-4.1245	11.2367	-87.7004	-12.5034	10.6883	-87.8658
	1.152	-8.3312	11.2343	-89.1544	-0.0499	-3.1034	-4.8504	11.3672	-89.3284	-11.8121	11.1013	-88.9805
	1.168	-8.567	11.306	-90.1621	-0.1719	-3.0903	-4.9028	11.4941	-90.799	-12.2312	11.1179	-89.5253
	1.184	-9.3353	11.3792	-91.4961	-0.1597	-3.0758	-5.8867	11.6064	-92.0526	-12.7839	11.1519	-90.9395
	1.2	-10.7792	12.1167	-93.0952	-0.1408	-2.9772	-7.2566	12.7013	-93.6012	-14.3017	11.5322	-92.5892
	1.216	-10.8327	11.8771	-94.6311	-0.3041	-3.113	-7.2542	11.9796	-95.7546	-14.4111	11.7747	-93.5076
	1.232	-12.1633	12.0635	-95.7986	-0.3287	-3.0021	-8.9322	12.5172	-96.9116	-15.3944	11.6098	-94.6857
	1.248	-12.6698	12.1436	-97.371	-0.3185	-3.0445	-9.1794	12.4834	-98.5274	-16.1601	11.8038	-96.2145
	1.264	-13.9807	12.5109	-99.0321	-0.3476	-2.9868	-10.7702	13.0117	-100.2095	-17.1911	12.01	-97.8548
	1.28	-13.9841	11.6019	-100.8481	-0.2912	-2.7573	-11.3292	12.6756	-101.7066	-16.6391	10.5281	-99.9896
	1.296	-15.7155	11.5334	-102.5508	-0.2504	-2.8677	-13.1056	12.2665	-103.2443	-18.3254	10.8002	-101.8573
	1.312	-16.5051	12.18	-104.1649	-0.2421	-2.907	-13.6875	12.8534	-104.8804	-19.3227	11.5066	-103.4493
	1.328	-16.9523	12.2458	-105.5451	-0.2452	-2.9588	-14.4589	12.7069	-106.1795	-19.4458	11.7848	-104.9106
	1.344	-17.9148	12.2765	-107.3881	-0.2682	-2.9634	-15.0034	12.8008	-108.2011	-20.8263	11.7522	-106.5752
	1.36	-19.1442	12.4453	-109.2782	-0.2735	-3.0265	-16.2058	12.7851	-110.108	-22.0827	12.1055	-108.4484
	1.376	-20.5748	12.5425	-110.669	-0.2018	-3.0011	-17.5036	12.9769	-111.3035	-23.6459	12.1081	-110.0344
	1.392	-22.1214	12.8046	-112.8655	-0.1142	-3.0805	-17.59	12.5272	-113.3865	-26.6528	13.082	-112.3446
	1.408	-22.8663	12.9316	-115.1481	-0.0812	-3.103	-18.7787	12.7735	-115.4812	-26.954	13.0896	-114.8151
	1.424	-23.8588	12.9786	-116.5501	-0.1056	-3.0713	-19.0291	12.6385	-117.0631	-28.6884	13.3187	-116.0371
	1.44	-23.4999	12.5759	-118.026	-0.2228	-3.0768	-20.0939	12.7969	-118.7994	-26.9058	12.3549	-117.2526
	1.456	-26.3624	13.7119	-120.377	-0.0983	-3.0332	-20.9544	13.1232	-120.9133	-31.7704	14.3005	-119.8406
	1.472	-25.6065	12.9	-122.0729	-0.0008	-3.1204	-20.9461	12.9987	-122.0764	-30.2668	12.8014	-122.0693
	1.488	-27.3981	14.4319	-124.6732	0.2921	2.8657	-22.9788	13.1807	-123.2922	-31.8174	15.6832	-126.0542
	1.504	-26.8388	14.546	-126.7162	0.2636	2.8213	-22.2699	13.0305	-125.4171	-31.4077	16.0616	-128.0152
	1.52	-27.4514	14.4852	-128.7798	0.7058	2.8113	-24.6927	13.5395	-126.2942	-30.2101	15.431	-131.2654
	1.536	-27.0177	14.6215	-130.9254	0.8306	2.7932	-24.3703	13.6601	-127.8422	-29.6652	15.583	-134.0086
	1.552	-27.484	14.5962	-132.8143	1.1134	2.4802	-26.3434	13.7084	-129.8779	-28.6246	15.4841	-135.7508
	1.568	-26.4367	14.5306	-134.1724	1.3411	1.454	-26.5281	13.7515	-130.8168	-26.3453	15.3097	-137.528
	1.584	-27.2516	15.8559	-135.2301	1.2062	1.5031	-27.333	14.6554	-132.077	-27.1702	17.0565	-138.3832
	1.6	-26.8366	15.8462	-135.6428	1.0787	0.4566	-28.0303	15.2599	-133.1622	-25.6429	16.4326	-138.1234
	1.616	-25.5302	15.7132	-136.1621	0.6982	0.3798	-27.8817	14.7745	-134.0371	-23.1787	16.6518	-138.287
	1.632	-24.7468	16.128	-137.3364	0.6061	0.4465	-27.2404	14.934	-135.42	-22.2532	17.3219	-139.2528
	1.648	-24.1684	16.3343	-138.1463	0.523	0.473	-27.0185	14.876	-136.3006	-21.3183	17.7926	-139.992
	1.664	-23.8596	15.8343	-139.159	0.6014	-0.0843	-27.0759	16.106	-136.9443	-20.6434	15.5626	-141.3737

Ma10

time	pos(x)	pos(y)	pos(z)	el	az	x1	y1	z1	x2	y2	z2
1.68	-24.0088	16.6792	-140.0818	0.5663	0.2776	-27.0935	15.8001	-138.0425	-20.9241	17.5582	-142.121
1.696	-22.9603	15.5349	-140.7281	0.3495	0.5805	-25.7744	13.6892	-139.5017	-20.1463	17.3806	-141.9545
1.712	-22.6369	15.2164	-141.1114	0.1062	0.4914	-25.731	13.5603	-140.7372	-19.5429	16.8725	-141.4857
1.728	-22.6624	16.1469	-142.6735	-0.0977	0.4909	-25.4372	14.6637	-142.9819	-19.8876	17.6301	-142.3651
1.744	-22.1976	16.0165	-143.7039	-0.0337	0.323	-25.5237	14.9034	-143.8222	-18.8716	17.1296	-143.5855
1.76	-22.3858	16.3649	-144.944	-0.0898	0.3178	-25.6335	15.2966	-145.2518	-19.1381	17.4333	-144.6362
1.776	-22.7352	17.1746	-146.4722	-0.0234	0.2785	-26.5915	16.0718	-146.5659	-18.8789	18.2774	-146.3785
1.792	-22.7539	17.186	-147.4384	-0.1877	0.5197	-25.5387	15.5927	-148.0476	-19.969	18.7792	-146.8291
1.808	-22.7798	17.4011	-149.6793	-0.0444	0.3667	-26.1364	16.112	-149.8391	-19.4232	18.6903	-149.5196
1.824	-21.9683	17.5407	-150.9967	-0.0604	0.3486	-25.45	16.2753	-151.2209	-18.4866	18.8062	-150.7726
1.84	-22.497	17.6422	-152.3068	-0.0766	0.3771	-25.9601	16.2707	-152.5925	-19.0339	19.0137	-152.021
1.856	-21.9202	17.8609	-154.1911	-0.0413	0.3291	-25.5452	16.6228	-154.3495	-18.2953	19.0991	-154.0326
1.872	-21.632	18.328	-155.3113	0.0321	0.3125	-25.1389	17.1948	-155.1932	-18.1251	19.4612	-155.4295
1.888	-22.179	18.2462	-157.3348	0.3295	0.4455	-25.3752	16.7202	-156.1235	-18.9828	19.7723	-158.5462
1.904	-22.4817	18.4889	-159.3503	0.5955	0.4998	-24.9203	17.1572	-157.4677	-20.0431	19.8206	-161.2329
1.92	-23.0914	18.8122	-160.4744	0.5669	0.6136	-25.2441	17.2962	-158.7981	-20.9387	20.3282	-162.1507
1.936	-23.3	18.8963	-162.8208	0.9293	0.736	-24.8112	17.5274	-160.0908	-21.7889	20.2652	-165.5508
1.952	-24.277	19.0717	-164.5303	1.0929	0.3819	-25.53	18.5685	-161.9231	-23.024	19.5749	-167.1375
1.968	-24.5701	19.2305	-166.0446	1.0286	0.5905	-26.0085	18.2662	-163.17	-23.1316	20.1948	-168.9193
1.984	-24.7982	19.5254	-167.6254	1.0886	0.9834	-25.5849	18.3437	-164.9134	-24.0115	20.707	-170.3374
2	-25.5852	19.5428	-169.2736	1.3863	1.8367	-25.4236	18.9494	-165.978	-25.7468	20.1362	-172.5692
2.016	-26.5307	18.9687	-171.0671	1.4991	2.005	-26.44	18.7731	-168.0652	-26.6213	19.1642	-174.0691
2.032	-27.0215	17.9949	-171.8859	1.3637	3.089	-26.3141	17.9577	-168.515	-27.7289	18.0321	-175.2568
2.048	-27.6803	18.7675	-172.8282	1.0544	2.9732	-25.9116	18.4668	-169.6683	-29.4491	19.0681	-175.9881
2.064	-28.9314	18.5404	-173.3373	0.8744	3.0246	-26.9274	18.3049	-170.9241	-30.9354	18.7759	-175.7505
2.08	-29.2272	17.9908	-174.3952	0.7293	3.0155	-26.5849	17.6558	-172.0151	-31.8696	18.3259	-176.7753
2.096	-30.4971	18.5243	-175.0435	0.5248	3.0447	-26.9509	18.1795	-172.9805	-34.0433	18.8691	-177.1064
2.112	-30.965	18.8252	-175.4686	0.4134	2.8953	-27.1491	17.8661	-173.7426	-34.7808	19.7843	-177.1946
2.128	-30.6485	18.5058	-176.6629	0.3639	2.9393	-26.6329	17.6824	-175.1018	-34.664	19.3293	-178.224
2.144	-30.1907	18.2203	-176.9869	0.2272	3.0862	-25.9478	17.985	-176.0047	-34.4335	18.4557	-177.9692
2.16	-30.6225	18.826	-178.1398	0.0602	2.9669	-25.9908	18.0087	-177.8564	-35.2541	19.6433	-178.4232
2.176	-30.5059	18.8667	-178.9296	0.2223	2.9161	-26.1894	17.8767	-177.9287	-34.8224	19.8567	-179.9305
2.192	-32.0772	19.0776	-179.6434	0.2863	3.0031	-28.3533	18.5586	-178.5365	-35.8011	19.5967	-180.7503
2.208	-32.2559	19.2429	-180.7221	0.0752	2.9779	-28.407	18.6073	-180.4281	-36.1048	19.8786	-181.0161
2.224	-31.9323	19.3739	-182.1204	0.0464	2.9837	-27.4165	18.6548	-181.9081	-36.448	20.0929	-182.3326
2.24	-33.7031	19.7036	-183.4166	-0.0396	2.9572	-28.1961	18.6765	-183.6385	-39.2101	20.7307	-183.1947
2.256	-34.2825	19.365	-184.3703	-0.0417	2.9266	-29.1459	18.2434	-184.5897	-39.4191	20.4866	-184.151
2.272	-34.5373	19.2675	-185.9572	-0.0264	2.9257	-28.8562	18.0216	-186.1109	-40.2183	20.5134	-185.8035
2.288	-34.1788	19.3271	-187.8024	0.0614	2.9405	-28.6497	18.2003	-187.4553	-39.7079	20.454	-188.1496
2.304	-34.5965	18.913	-189.1395	0.024	2.9735	-29.128	17.9848	-189.0061	-40.0651	19.8412	-189.2729
2.32	-34.7518	19.0208	-190.2666	-0.0097	2.9864	-29.1607	18.1463	-190.3217	-40.3428	19.8952	-190.2115
2.336	-34.6955	18.725	-192.3467	0.049	2.9953	-29.6568	17.9828	-192.0967	-39.7342	19.4673	-192.5967
2.352	-36.0497	18.4389	-194.1942	0.0882	3.0065	-30.6287	17.702	-193.7103	-41.4706	19.1759	-194.6782
2.368	-36.0676	18.9967	-196.1343	0.0087	2.9849	-31.5273	18.2793	-196.0943	-40.6079	19.7142	-196.1742
2.384	-37.026	18.8596	-197.9585	0.1189	2.9773	-31.8024	17.9938	-197.3261	-42.2496	19.7254	-198.591
2.4	-37.01	18.316	-199.8506	0.0989	3.0423	-31.7619	17.7931	-199.3275	-42.2582	18.8389	-200.3736
2.416	-37.3387	18.5814	-201.1394	0.1045	3.0303	-33.1169	18.1098	-200.694	-41.5606	19.053	-201.5847
2.432	-37.0503	17.9263	-203.6272	0.0702	3.011	-32.1603	17.2839	-203.2806	-41.9403	18.5688	-203.9738
2.448	-36.9719	18.1037	-205.4248	0.1698	3.0629	-32.5337	17.7536	-204.6614	-41.4101	18.4538	-206.1881
2.464	-35.9386	17.6293	-208.0535	0.5085	3.0584	-31.9351	17.2955	-205.8144	-39.9422	17.9632	-210.2926
2.48	-36.5809	17.721	-209.7241	1.0265	-2.8909	-34.939	18.1415	-206.9239	-38.2229	17.3006	-212.5244
2.496	-35.9282	17.5489	-211.6768	0.9802	-3.0609	-34.0627	17.6997	-208.8851	-37.7937	17.398	-214.4684
2.512	-36.6	17.6515	-213.9888	1.0229	3.097	-34.5346	17.5594	-210.6008	-38.6654	17.7437	-217.3768
2.528	-32.8748	17.065	-215.8449	1.4331	-1.3098	-33.002	17.541	-212.2898	-32.7477	16.589	-219.3999
2.544	-34.0922	17.4626	-217.4613	1.4263	-1.0215	-34.3227	17.8391	-214.4283	-33.8618	17.0862	-220.4944
2.56	-34.1881	18.3448	-218.7183	1.3873	0.7821	-34.6097	17.9259	-215.516	-33.7664	18.7636	-221.9206
2.576	-33.382	18.7373	-219.3924	0.9677	0.2815	-35.1937	18.2134	-216.6539	-31.5703	19.2612	-222.131
2.592	-30.8163	18.2942	-220.0427	0.7918	0.0882	-33.6193	18.0464	-217.1924	-28.0133	18.5419	-222.8931
2.608	-30.0809	19.0977	-221.2229	0.7319	0.077	-33.0532	18.8684	-218.5446	-27.1087	19.327	-223.9012
2.624	-29.2611	18.2063	-221.6507	0.6189	0.0741	-32.5445	17.9627	-219.3059	-25.9778	18.4499	-223.9956
2.64	-29.3443	18.1314	-222.2511	0.5577	0.2621	-32.3891	17.3147	-220.2849	-26.2995	18.9481	-224.2172
2.656	-30.1961	19.7072	-223.1489	0.3647	0.4134	-33.1604	18.4068	-221.9131	-27.2318	21.0076	-224.3847
2.672	-29.2582	19.007	-224.4916	0.4802	0.3921	-32.2689	17.7619	-222.7948	-26.2475	20.252	-226.1884
2.688	-28.7737	18.8071	-225.4966	0.143	0.2965	-32.7056	17.6059	-224.9045	-24.8418	20.0084	-226.0887
2.704	-28.2919	18.3396	-227.0489	0.0572	0.3698	-32.279	16.7941	-226.8039	-24.3049	19.885	-227.294
2.72	-26.2927	18.1939	-226.012	0.0136	0.3204	-30.0541	16.9459	-225.9579	-22.5313	19.4419	-226.0661

Ma10	time	pos(x)	pos(y)	pos(z)	el	az	x1	y1	z1	x2	y2	z2
	2.736	-26.9942	18.9097	-228.1438	-0.0419	0.5453	-30.0401	17.062	-228.2931	-23.9482	20.7574	-227.9945
	2.752	-27.2617	19.128	-230.5376	-0.0027	0.357	-31.1648	17.6724	-230.5488	-23.3586	20.5835	-230.5265
	2.768	-26.73	18.8327	-230.7696	-0.2924	0.5731	-29.247	17.2085	-231.6714	-24.213	20.457	-229.8677
	2.784	-26.8073	19.3708	-232.384	-0.3292	0.7084	-29.0372	17.4605	-233.3873	-24.5775	21.2811	-231.3808
	2.8	-25.8408	18.9726	-233.4506	-0.453	0.3994	-28.8557	17.7002	-235.0434	-22.8258	20.245	-231.8578
	2.816	-24.7814	19.0071	-234.9842	-0.3442	0.5694	-27.7023	17.1373	-236.2276	-21.8605	20.8769	-233.7409
	2.832	-24.5336	19.1391	-236.9172	-0.3448	0.4008	-27.3455	17.9476	-238.0142	-21.7217	20.3306	-235.8203
	2.848	-23.0074	18.7086	-238.6352	-0.4228	0.4086	-25.9087	17.4523	-240.0579	-20.106	19.9649	-237.2126
	2.864	-22.486	18.2004	-241.2242	-0.2773	0.427	-25.5454	16.8082	-242.1811	-19.4266	19.5925	-240.2674
	2.88	-22.6622	18.4634	-242.2557	-0.1135	0.368	-26.1169	17.1314	-242.6777	-19.2074	19.7955	-241.8337
	2.896	-22.5007	19.2969	-243.2871	-0.064	0.5653	-25.8263	17.1873	-243.5396	-19.1751	21.4066	-243.0347
	2.912	-21.4247	19.0913	-245.6627	-0.1868	0.6532	-24.4626	16.7666	-246.3857	-18.3867	21.4159	-244.9397
	2.928	-19.1168	18.865	-248.1052	0.0208	0.4863	-22.4502	17.1026	-248.0268	-15.7834	20.6273	-248.1837
	2.944	-20.6001	19.3799	-250.8156	-0.0184	0.369	-24.6058	17.831	-250.8948	-16.5944	20.9288	-250.7364
	2.96	-20.1884	18.9283	-251.9123	0.2462	0.7573	-23.1985	16.0827	-250.8714	-17.1782	21.774	-252.9532
	2.976	-20.4743	19.0592	-255.0926	0.5048	0.4619	-23.3507	17.6273	-253.3174	-17.5979	20.491	-256.8679
	2.992	-19.4852	18.6861	-257.06	0.4532	0.4144	-22.7072	17.2687	-255.3458	-16.2632	20.1034	-258.7741
	3.008	-19.4499	18.775	-259.6923	0.6599	0.221	-22.564	18.0755	-257.2159	-16.3359	19.4745	-262.1686
	3.024	-19.3458	18.5697	-262.447	0.845	0.1917	-21.966	18.0612	-259.4391	-16.7256	19.0782	-265.4548
	3.04	-20.3132	18.4341	-263.6138	0.9874	0.7445	-21.7563	17.1044	-260.6405	-18.8701	19.7639	-266.587
	3.056	-19.9363	17.7596	-265.1144	1.1847	0.1626	-21.2705	17.5408	-261.7885	-18.602	17.9784	-268.4403
	3.072	-19.76	16.961	-267.3437	1.4581	0.1787	-20.1181	16.8963	-264.1285	-19.4019	17.0257	-270.5588
	3.088	-21.3576	16.7811	-268.9913	1.49	-0.3697	-21.6282	16.886	-265.4095	-21.087	16.6763	-272.5731
	3.104	-21.6225	15.7268	-269.7993	1.3664	-1.7732	-21.4924	16.3604	-266.6798	-21.7525	15.0933	-272.9188
	3.12	-22.9426	15.3227	-269.77	1.0105	-2.767	-21.4498	15.9096	-267.2132	-24.4353	14.7359	-272.3267
	3.136	-22.7118	14.9459	-270.4915	0.7691	-2.9582	-20.5377	15.3493	-268.3513	-24.8858	14.5426	-272.6316
	3.152	-22.6712	14.8886	-270.9973	0.6578	-2.8815	-20.3478	15.507	-269.1397	-24.9945	14.2702	-272.855
	3.168	-22.4974	14.2769	-272.0617	0.4941	-2.9556	-19.4133	14.8571	-270.3715	-25.5815	13.6966	-273.752
	3.184	-23.1494	14.7633	-272.9637	0.5872	-2.895	-20.5023	15.4297	-271.1472	-25.7964	14.0969	-274.7801
	3.2	-23.5061	14.0733	-273.8138	0.3655	-3.0582	-20.0216	14.3645	-272.4757	-26.9907	13.782	-275.1518
	3.216	-22.6469	13.6296	-274.1194	0.3259	3.1124	-18.6532	13.5129	-272.7692	-26.6406	13.7463	-275.4696
	3.232	-23.5147	13.9843	-275.4709	0.2736	3.0853	-19.4193	13.7537	-274.3199	-27.61	14.215	-276.6219
	3.248	-23.1249	13.8994	-276.0136	0.1068	2.9689	-18.7453	13.1355	-275.537	-27.5046	14.6632	-276.4901
	3.264	-23.3434	13.2342	-277.5989	0.1452	2.9848	-17.6125	12.3283	-276.7503	-29.0743	14.1401	-278.4475
	3.28	-24.0353	13.9413	-278.4489	0.1788	2.9761	-19.0154	13.1028	-277.5292	-29.0553	14.7799	-279.3685
	3.296	-24.0153	13.4164	-279.6645	0.1233	3.0279	-19.1836	12.8647	-279.0618	-28.847	13.9681	-280.2672
	3.312	-24.4714	13.1484	-281.2453	0.1657	3.0073	-20.0402	12.5497	-280.4974	-28.9027	13.7472	-281.9933
	3.328	-23.8866	12.2451	-282.4916	0.1662	2.967	-19.5636	11.4828	-281.7553	-28.2097	13.0075	-283.2278
	3.344	-23.8808	12.1763	-283.8665	0.2213	3.0031	-19.5992	11.5794	-282.8937	-28.1623	12.7731	-284.8394
	3.36	-25.2334	12.5632	-284.9687	0.0825	2.905	-19.728	11.236	-284.5004	-30.7389	13.8904	-285.437
	3.376	-24.4058	12.2957	-286.6301	0.1707	2.8785	-19.4413	10.9588	-285.744	-29.3703	13.6327	-287.5162
	3.392	-24.1243	11.782	-288.1064	0.1759	2.9396	-19.6515	10.8661	-287.295	-28.5972	12.6979	-288.9178
	3.408	-24.7031	11.7207	-288.8649	0.2092	2.9944	-19.5142	10.9513	-287.7512	-29.892	12.4901	-289.9786
	3.424	-24.1418	10.7598	-291.6862	0.1459	2.9511	-18.6484	9.7003	-290.864	-29.6353	11.8194	-292.5084
	3.44	-24.5381	10.411	-292.982	0.1843	2.9456	-19.5285	9.4162	-292.0301	-29.5476	11.4058	-293.9338
	3.456	-25.2487	9.7334	-295.2142	0.5405	-2.9898	-22.1426	10.2086	-293.3283	-28.3548	9.2583	-297.1001
	3.472	-24.4599	9.0366	-296.6195	0.6932	-2.7486	-22.3193	9.9241	-294.6945	-26.6005	8.1491	-298.5445
	3.488	-24.904	9.2132	-297.9246	0.5764	-2.9511	-22.0013	9.773	-296.003	-27.8067	8.6534	-299.8462
	3.504	-24.6363	9.1667	-299.1384	0.5149	-2.9435	-21.3238	9.8318	-297.2267	-27.9487	8.5017	-301.0501
	3.52	-23.3096	8.5303	-300.9197	1.0263	-1.9691	-22.7864	9.7738	-298.6921	-23.8329	7.2868	-303.1473
	3.536	-23.5596	8.0311	-302.3471	0.8912	-2.1224	-22.8081	9.2525	-300.5725	-24.3111	6.8097	-304.1218
	3.552	-22.4518	7.7373	-304.8914	1.1948	-1.6538	-22.3675	8.7501	-302.3173	-22.536	6.7246	-307.4656
	3.568	-21.8897	7.8189	-306.1161	1.3027	-1.0281	-22.2884	8.48	-303.3061	-21.491	7.1578	-308.9261
	3.584	-22.3098	9.1833	-308.2771	1.3674	-0.4459	-22.9419	9.4855	-304.8804	-21.6776	8.8811	-311.6738
	3.6	-20.5189	9.0009	-309.2556	0.8354	0.0861	-22.9674	8.7896	-306.5392	-18.0704	9.2122	-311.972
	3.616	-19.7437	8.8471	-310.365	0.7972	-0.0763	-22.458	9.0545	-307.5778	-17.0293	8.6397	-313.1522
	3.632	-18.7817	8.3074	-310.9639	0.7856	0.1838	-21.3832	7.8238	-308.3165	-16.1802	8.7911	-313.6113
	3.648	-17.9655	9.4425	-311.7395	0.7673	0.0732	-20.8715	9.2293	-308.9291	-15.0594	9.6557	-314.5499
	3.664	-18.0674	9.5485	-312.5411	0.7232	0.0648	-20.6935	9.3781	-310.2181	-15.4413	9.7189	-314.8642
	3.68	-16.7955	8.2858	-313.2468	0.6137	0.0146	-19.7158	8.2431	-311.1894	-13.8751	8.3286	-315.3041
	3.696	-16.8101	8.2682	-313.8345	0.5067	0.2338	-20.4952	7.3906	-311.7318	-13.125	9.1457	-315.9373

Manta 11	v1= 2.398	pos(x)	pos(y)	pos(z)	el	az	x1	y1	z1	x2	y2	z2
0.032	-0.3924	0.6154	-7.6727	0.3236	0.2334	-3.0975	-0.0276	-6.7403	2.3128	1.2585	-8.6051	
0.048	-0.5785	0.7591	-12.2709	0.5494	0.3309	-2.913	-0.0429	-10.7596	1.756	1.561	-13.7822	
0.064	-1.56	1.608	-14.2558	0.8483	0.7473	-2.738	0.5164	-12.434	-0.3819	2.6996	-16.0776	
0.08	-2.127	1.8128	-17.9847	1.1565	2.2308	-1.5046	1.0108	-15.6761	-2.7495	2.6149	-20.2933	
0.096	-3.5816	1.5815	-20.8772	0.7344	2.7506	-1.5635	0.7497	-18.9066	-5.5996	2.4134	-22.8477	
0.112	-4.1321	2.8448	-22.2089	0.5907	2.8696	-1.908	2.2245	-20.6604	-6.3563	3.4651	-23.7575	
0.128	-5.0221	3.2047	-24.345	0.6243	3.1015	-2.3721	3.0984	-22.4345	-7.672	3.3109	-26.2556	
0.144	-5.6677	2.4083	-26.1325	0.1644	2.9586	-2.1432	1.7563	-25.5379	-9.1921	3.0604	-26.7271	
0.16	-6.062	3.6889	-26.1501	0.1324	2.9963	-2.6903	3.1955	-25.6962	-9.4338	4.1823	-26.604	
0.176	-6.6704	2.3455	-29.8719	0.2136	-3.0709	-3.4333	2.5749	-29.1681	-9.9074	2.1162	-30.5757	
0.192	-6.2707	3.5033	-31.3769	0.231	2.9736	-3.1069	2.9668	-30.6221	-9.4345	4.0399	-32.1316	
0.208	-7.5323	4.3589	-31.2679	0.0889	2.9988	-3.7099	3.8093	-30.9238	-11.3547	4.9084	-31.6121	
0.224	-7.2045	4.2151	-32.5453	0.0403	2.9628	-3.7846	3.5969	-32.4051	-10.6244	4.8332	-32.6854	
0.24	-7.4032	4.2084	-35.5557	0.3435	2.8304	-4.7528	3.356	-34.56	-10.0537	5.0608	-36.5515	
0.256	-7.2713	4.1037	-37.0802	0.2758	2.8651	-4.0556	3.1911	-36.1341	-10.487	5.0163	-38.0264	
0.272	-7.4242	4.3773	-38.9315	0.4978	2.762	-5.1482	3.4693	-37.5999	-9.7001	5.2853	-40.2631	
0.288	-6.5953	4.2663	-40.8346	0.7338	2.9214	-4.6393	3.8284	-39.0268	-8.5513	4.7041	-42.6423	
0.304	-5.606	4.6571	-42.0277	1.1453	2.735	-4.6369	4.2398	-39.6992	-6.5751	5.0744	-44.3562	
0.32	-5.0529	5.3897	-43.1913	1.0861	2.364	-4.1671	4.5177	-40.8311	-5.9386	6.2617	-45.5516	
0.336	-3.597	5.0687	-44.5667	1.3259	1.1129	-3.9283	4.3965	-41.568	-3.2657	5.7409	-47.5655	
0.352	-2.2852	6.4277	-44.3619	0.9512	0.698	-3.3833	5.5064	-42.3525	-1.187	7.3489	-46.3714	
0.368	-1.2949	6.1978	-45.1476	0.8218	0.4059	-2.7299	5.5811	-43.4677	0.1401	6.8145	-46.8274	
0.384	-0.1773	5.7717	-46.8041	0.7884	0.1294	-2.3469	5.4893	-44.603	1.9922	6.0542	-49.0052	
0.4	0.3371	5.9343	-46.4108	0.4477	0.1097	-2.2816	5.646	-45.1458	2.9557	6.2226	-47.6758	
0.416	0.2121	6.0122	-48.0802	0.4299	0.1268	-2.6967	5.6413	-46.7357	3.1209	6.3831	-49.4246	
0.432	1.061	6.2548	-48.3601	0.3129	0.0406	-2.3395	6.1165	-47.2592	4.4615	6.9391	-49.461	
0.448	1.3093	6.5514	-49.1983	0.264	-0.0167	-2.033	6.6073	-48.2948	4.6517	6.4955	-50.1019	
0.464	2.1352	6.6358	-49.6789	0.1383	-0.0642	-1.3107	6.8573	-49.1984	5.5811	6.4144	-50.1595	
0.48	2.9656	6.6321	-50.2963	-0.0145	-0.0066	-0.5715	6.6555	-50.3475	6.5026	6.6086	-50.2452	
0.496	3.9636	6.6417	-50.3765	-0.0339	0.0496	0.2879	6.4594	-50.5013	7.6393	6.824	-50.2516	
0.512	3.245	7.5033	-51.2839	0.0072	-0.0251	-0.5897	7.5996	-51.2563	7.0798	7.4069	-51.3114	
0.528	3.4648	7.1045	-52.3698	0.0048	-0.0361	-0.6772	7.2542	-52.3499	7.6067	6.9549	-52.3897	
0.544	4.0028	7.1815	-52.7448	-0.0311	0.0511	0.085	6.9812	-52.8667	7.9205	7.3819	-52.6229	
0.56	4.093	7.5705	-53.8849	-0.0747	-0.0388	-0.2336	7.7386	-54.2089	8.4196	7.4024	-53.5609	
0.576	5.7661	6.7712	-54.9075	-0.0761	-0.0591	2.3044	6.9759	-55.1719	9.2277	6.5665	-54.6431	
0.592	6.1198	7.0619	-55.4722	-0.1353	-0.1583	2.575	7.628	-55.9609	9.6646	6.4959	-54.9835	
0.608	6.6387	7.2106	-56.7771	-0.2862	-0.1308	3.8238	7.5809	-57.6127	9.4536	6.8404	-55.9416	
0.624	7.6147	6.9193	-57.8816	-0.2902	-0.0943	3.8151	7.2786	-59.0215	11.4143	6.56	-56.7418	
0.64	7.9398	7.142	-59.0811	-0.3761	-0.0607	4.4913	7.3517	-60.4455	11.3883	6.9323	-57.7167	
0.656	8.3969	7.4307	-60.0068	-0.4793	-0.0115	5.3459	7.4657	-61.5927	11.4478	7.3957	-58.4209	
0.672	9.1866	7.2224	-61.3306	-0.4535	-0.1576	5.8104	7.7589	-62.9969	12.5629	6.6859	-59.6642	
0.688	9.4461	7.5059	-62.9646	-0.5216	-0.0125	6.4998	7.5428	-64.6578	12.3924	7.469	-61.2715	
0.704	10.0667	7.6356	-64.0576	-0.4656	-0.1026	6.9186	7.9597	-65.6477	13.2148	7.3115	-62.4674	
0.72	11.0836	7.9976	-65.6101	-0.487	-0.0746	7.5466	8.2619	-67.4884	14.6206	7.7332	-63.7318	
0.736	12.1127	8.1373	-66.4891	-0.4576	-0.122	8.2624	8.6092	-68.3995	15.9629	7.6654	-64.5786	
0.752	12.9233	8.3	-67.4013	-0.586	-0.0954	9.6139	8.6167	-69.608	16.2328	7.9832	-65.1947	
0.768	13.4517	8.6323	-69.525	-0.5803	-0.0427	10.2388	8.7694	-71.6331	16.6645	8.4951	-67.417	
0.784	14.5815	8.9697	-71.0735	-0.5472	-0.083	11.3992	9.2345	-73.0192	17.7637	8.7049	-69.1277	
0.8	16.9362	9.5781	-72.104	-0.6464	-0.0212	13.836	9.6438	-74.4439	20.0364	9.5125	-69.764	
0.816	17.2523	9.5983	-73.9746	-0.7685	-0.089	14.9793	9.8012	-76.1809	19.5252	9.3955	-71.7683	
0.832	19.0348	9.7959	-75.2327	-0.6656	-0.1742	16.3287	10.2721	-77.39	21.7408	9.3197	-73.0754	
0.848	20.2264	9.5	-76.979	-0.6231	-0.1118	16.8726	9.8766	-79.4039	23.5801	9.1235	-74.554	
0.864	21.5606	10.0094	-78.2219	-0.6861	-0.2074	18.7647	10.5978	-80.5614	24.3564	9.4211	-75.8824	
0.88	24.1967	9.9783	-80.2689	-0.6137	0.099	21.3961	9.7002	-82.2517	26.9973	10.2564	-78.2862	
0.896	24.9894	10.4363	-81.9282	-0.4582	-0.0742	21.4698	10.698	-83.6689	28.509	10.1746	-80.1876	
0.912	26.404	10.7099	-83.5984	-0.4498	-0.0883	23.1165	11.001	-85.1917	29.6914	10.4187	-82.0051	
0.928	28.8841	11.8047	-85.7547	-0.4166	-0.1896	25.5556	12.4435	-87.2546	32.2125	11.1658	-84.2548	
0.944	30.0369	11.329	-88.7096	-0.4882	-0.1867	26.5883	11.9803	-90.5736	33.4854	10.6776	-86.8457	
0.96	30.2428	11.8651	-90.4243	-0.3878	-0.1749	26.9112	12.4539	-91.8063	33.5744	11.2763	-89.0423	
0.976	31.7325	11.4397	-92.3496	-0.352	-0.1788	28.0557	12.1041	-93.7218	35.4092	10.7754	-90.9774	
0.992	31.6527	12.9573	-94.2574	0.2205	-0.2646	27.839	13.9907	-93.3719	35.4665	11.9239	-95.143	
1.008	31.8788	12.2597	-96.2563	0.182	-0.2937	27.8122	13.4898	-95.4746	35.9454	11.0297	-97.038	
1.024	33.0252	13.2897	-98.405	0.5005	0.084	29.523	12.9948	-96.4828	36.5274	13.5846	-100.3273	
1.04	33.6284	13.674	-100.0872	0.691	0.2706	30.9715	12.937	-97.8068	36.2853	14.4111	-102.3677	
1.056	33.4147	14.9209	-101.2472	0.9291	0.7216	32.021	13.6944	-98.7626	34.8084	16.1473	-103.7317	

Mal1

time	pos(x)	pos(y)	pos(z)	el	az	x1	y1	z1	x2	y2	z2
1.072	32.0458	15.998	-103.0031	1.1325	1.3578	31.7997	14.8601	-100.519	32.2918	17.1358	-105.4871
1.088	31.6234	15.202	-105.2352	1.2906	1.7107	31.7319	14.4314	-102.5304	31.5149	15.9726	-107.9399
1.104	31.2605	14.7255	-106.4832	1.2509	1.9647	31.5874	13.9391	-103.9123	30.9337	15.5119	-109.054
1.12	31.1279	15.3651	-107.293	1.1802	2.3979	31.9142	14.6418	-104.698	30.3415	16.0884	-109.8881
1.136	30.0023	15.6797	-108.0687	1.021	2.7017	31.3842	15.0294	-105.5768	28.6205	16.33	-110.5606
1.152	29.0539	16.244	-108.6124	0.7965	2.6494	30.9429	15.231	-106.4208	27.1648	17.2569	-110.8039
1.168	28.6147	16.4583	-108.9812	0.5442	2.5359	30.8693	14.8971	-107.3215	26.3601	18.0195	-110.6408
1.184	28.8335	16.4521	-109.6804	0.5747	2.728	31.435	15.3102	-107.8403	26.232	17.594	-111.5205
1.2	28.418	16.6779	-110.2928	0.4654	2.8774	31.3493	15.885	-108.7678	25.4868	17.4707	-111.8177
1.216	28.3192	16.5514	-111.619	0.4132	2.6743	31.1269	15.1349	-110.2401	25.5115	17.9679	-112.9978
1.232	27.7779	17.1094	-112.5293	0.419	2.6257	30.4672	15.5843	-111.1525	25.0886	18.6345	-113.906
1.248	26.2379	16.9105	-112.3743	0.1207	2.8251	29.2917	15.9103	-111.9846	23.1841	17.9107	-112.764
1.264	26.8286	17.0714	-113.4286	0.0049	2.8491	30.2895	16.0292	-113.4109	23.3677	18.1136	-113.4462
1.28	26.2561	17.2661	-114.2135	-0.0081	2.85	30.2706	16.061	-114.2476	22.2416	18.4711	-114.1795
1.296	26.8485	18.1084	-115.4953	-0.0531	2.8744	30.4505	17.1222	-115.6936	23.2465	19.0946	-115.2969
1.312	25.3226	18.5099	-117.0713	-0.0231	2.8561	29.4969	17.2848	-117.172	21.1483	19.735	-116.9705
1.328	27.273	18.1087	-118.2698	0.0249	2.8058	30.5068	16.9801	-118.1846	24.0391	19.2373	-118.3549
1.344	26.7054	18.6241	-119.633	-0.0451	2.8145	30.051	17.4889	-119.7923	23.3599	19.7592	-119.4737
1.36	26.0903	18.7228	-120.8775	-0.0266	2.7844	29.9904	17.2674	-120.9881	22.1903	20.1782	-120.7668
1.376	26.6538	18.5635	-122.2759	-0.0118	2.8338	30.2547	17.419	-122.3204	23.0529	19.7081	-122.2314
1.392	26.5805	19.1289	-124.0845	-0.0925	2.791	30.3035	17.7676	-124.4521	22.8574	20.4902	-123.7169
1.408	26.4341	19.6147	-125.7268	-0.0246	2.7806	30.1401	18.2154	-125.8241	22.728	21.0139	-125.6295
1.424	25.6613	20.2524	-127.4145	0.1316	2.6798	29.0025	18.5895	-126.9204	22.3201	21.9152	-127.9086
1.44	26.478	19.9716	-129.1685	0.0036	2.7649	30.404	18.4187	-129.1533	22.5521	21.5245	-129.1838
1.456	25.3734	20.5773	-130.3856	0.2179	2.5655	28.1144	18.7968	-129.6618	22.6325	22.3578	-131.1094
1.472	25.5135	20.5743	-133.2498	0.4182	2.653	28.33	19.077	-131.8323	22.6969	22.0717	-134.6673
1.488	25.6792	20.7323	-135.1602	0.6048	2.6353	28.3837	19.2328	-133.0226	22.9748	22.2319	-137.2978
1.504	26.903	20.6736	-137.4069	0.9712	2.4667	28.413	19.4652	-134.5777	25.393	21.8819	-140.2362
1.52	27.0641	21.4455	-139.5834	0.9048	2.4398	28.5093	20.2237	-137.175	25.619	22.6672	-141.9917
1.536	26.9486	21.5575	-140.8608	1.0823	2.4264	28.0758	20.5783	-138.0513	25.8213	22.5367	-143.6704
1.552	29.0279	21.6122	-142.8448	1.3264	2.1096	29.4095	20.9738	-139.8623	28.6462	22.2506	-145.8273
1.568	29.9739	21.8243	-144.0714	1.3009	0.8874	29.4693	21.2047	-141.1834	30.4784	22.4439	-146.9594
1.584	30.5681	21.6285	-145.35	1.2224	1.1375	30.1358	20.694	-142.5149	31.0005	22.5631	-148.1851
1.6	31.4917	21.7353	-146.534	1.226	0.7431	30.7261	21.0319	-143.6397	32.2572	22.4387	-149.4283
1.616	32.9591	21.605	-147.9606	1.1399	0.2292	31.4942	21.2632	-144.6886	34.424	21.9467	-151.2326
1.632	33.0127	21.8366	-148.1107	0.9772	0.2004	31.0146	21.4308	-145.0892	35.0109	22.2424	-151.1322
1.648	34.0773	22.0686	-149.402	0.8284	0.2028	31.7587	21.592	-146.8218	36.3959	22.5453	-151.9821
1.664	33.8696	21.7595	-150.1092	0.9014	0.1296	31.7266	21.4801	-147.3781	36.0125	22.0389	-152.8404
1.68	34.8805	21.6218	-150.3486	0.5099	0.1567	31.3376	21.0622	-148.3428	38.4235	22.1814	-152.3544
1.696	35.5761	21.8375	-151.2032	0.5021	0.2216	31.5839	20.9383	-148.9563	39.5683	22.7368	-153.4501
1.712	35.9095	20.7968	-151.8426	0.3055	0.2092	32.0543	19.9782	-150.5998	39.7647	21.6154	-153.0854
1.728	37.5052	21.3542	-154.0324	0.396	0.247	33.7773	20.4144	-152.4251	41.233	22.294	-155.6396
1.744	36.2843	20.7528	-154.3215	0.2804	0.1088	32.4077	20.3295	-153.1984	40.1609	21.1762	-155.4446
1.76	36.5577	20.9154	-154.926	0.0827	0.1259	32.679	20.4244	-154.602	40.4365	21.4064	-155.2501
1.776	37.3646	20.8413	-156.7265	0.1442	0.2053	32.8397	19.8991	-156.0553	41.8894	21.7835	-157.3977
1.792	37.054	21.1611	-157.4891	0.0273	0.1292	33.2924	20.6723	-157.3855	40.8155	21.6499	-157.5927
1.808	37.584	20.8054	-159.4456	-0.2718	0.2237	34.4185	20.0854	-160.3504	40.7495	21.5254	-158.5409
1.824	38.1693	20.3021	-160.9248	-0.2506	0.1192	35.129	19.9378	-161.7085	41.2097	20.6664	-160.1411
1.84	38.6569	19.8595	-162.6298	-0.2056	0.1945	34.8828	19.116	-163.4318	42.431	20.6031	-161.8277
1.856	38.7793	20.1792	-163.6839	-0.1779	0.2077	34.7035	19.3203	-164.433	42.8552	21.0382	-162.9348
1.872	39.5693	20.3249	-165.8499	-0.2763	0.275	35.9273	19.2976	-166.9227	43.2113	21.3523	-164.7771
1.888	40.3871	20.5166	-166.6779	-0.6009	0.1376	37.1235	20.0647	-168.9363	43.6507	20.9684	-164.4194
1.904	40.4372	20.209	-167.8736	-0.7561	0.1187	37.3397	19.8396	-170.8156	43.5346	20.5784	-164.9316
1.92	41.7856	20.7178	-168.637	-0.7505	0.0395	38.617	20.5926	-171.5942	44.9543	20.843	-165.6797
1.936	43.5054	20.6219	-170.722	-0.69	-0.1494	40.323	21.1011	-173.3782	46.6879	20.1428	-168.0659
1.952	44	20.894	-171.98	-0.7512	-0.1719	40.7088	21.4655	-175.0992	47.2912	20.3226	-168.8608
1.968	44.7846	21.6375	-173.8174	-0.7147	-0.0479	41.5884	21.7906	-176.5942	47.9808	21.4843	-171.0407
1.984	46.3141	20.8591	-175.1909	-0.8874	-0.2487	43.8508	21.4846	-178.312	48.7773	20.2336	-172.0699
2	47.6106	21.4763	-176.6021	-1.0406	-0.1866	45.8047	21.8172	-179.7375	49.4164	21.1354	-173.4667
2.016	48.6032	22.0593	-178.3939	-0.8961	-0.2319	46.1028	22.6498	-181.6058	51.1035	21.4688	-175.182
2.032	51.0031	21.8571	-180.0091	-0.9173	-0.287	48.6935	22.5387	-183.1537	53.3127	21.1755	-176.8645
2.048	51.9309	21.5159	-180.7499	-0.9646	-0.27	49.8443	22.0935	-183.8732	54.0176	20.9384	-177.6266
2.064	53.6348	21.2224	-181.8251	-0.9852	-0.2034	51.5021	21.6624	-185.1086	55.7676	20.7824	-178.5417
2.08	54.8922	21.0757	-183.3523	-1.1405	-0.2546	53.2816	21.4949	-186.9788	56.5028	20.6565	-179.7258
2.096	56.6062	21.6539	-184.408	-1.4109	-0.4686	56.0941	21.913	-187.9665	57.1182	21.3947	-180.8494
2.112	59.3176	21.8366	-185.48	-1.2895	-0.5799	58.4429	22.4096	-189.0995	60.1923	21.2636	-181.8605

Mal1

time	pos(x)	pos(y)	pos(z)	el	az	x1	y1	z1	x2	y2	z2
2.128	59.7449	21.0554	-185.9099	-1.3236	0.7526	59.0792	20.432	-189.5235	60.4106	21.6788	-182.2963
2.144	60.1129	21.8224	-186.7478	-1.2765	0.3002	59.0736	21.5006	-190.3374	61.1523	22.1442	-183.1581
2.16	61.8485	21.0842	-187.9119	-1.4607	2.8565	62.2289	20.9727	-191.5	61.468	21.1957	-184.3238
2.176	64.1019	21.1189	-189.1828	-1.3187	-3.0017	64.9903	21.244	-192.6654	63.2135	20.9938	-185.7002
2.192	65.4357	22.9191	-189.7206	-1.178	3.0892	66.8916	22.8428	-193.2392	63.9799	22.9955	-186.2019
2.208	66.8268	23.289	-190.1481	-1.3349	-3.0723	67.6979	23.3495	-193.7803	65.9557	23.2285	-186.516
2.224	67.7275	23.214	-190.9296	-1.0802	-2.9083	69.4498	23.6232	-194.2436	66.0052	22.8047	-187.6156
2.24	69.3956	24.0702	-191.0076	-0.9226	-2.9333	71.8543	24.5898	-194.3258	66.937	23.5505	-187.6893
2.256	71.6105	23.2221	-192.2251	-0.8241	-3.0887	74.3739	23.3684	-195.2154	68.847	23.0757	-189.2347
2.272	71.8931	23.7085	-193.1664	-0.8485	3.1356	74.5792	23.6925	-196.2151	69.207	23.7245	-190.1177
2.288	72.0585	23.2708	-194.5087	-0.7409	-3.0508	74.7539	23.5163	-196.9843	69.3631	23.0254	-192.033
2.304	73.2843	24.714	-195.3319	-0.7771	-3.101	75.7962	24.8159	-197.8046	70.7724	24.612	-192.8593
2.32	73.7826	23.9313	-195.5748	-0.6819	-3.0088	76.5667	24.3033	-197.8549	70.9984	23.5593	-193.2947
2.336	74.8676	24.8608	-196.0039	-0.6022	-3.0403	78.4758	25.2275	-198.4966	71.2594	24.494	-193.5111
2.352	76.0409	25.2266	-197.2646	-0.5496	-3.0331	79.2405	25.575	-199.236	72.8414	24.8782	-195.2932
2.368	75.7027	25.5573	-197.4293	-0.5031	-2.9718	79.0347	26.1285	-199.2898	72.3707	24.9861	-195.5689
2.384	76.3119	25.8822	-198.7605	-0.4786	-3.0915	79.5478	26.0443	-200.4413	73.0761	25.7201	-197.0796
2.4	76.6316	25.4869	-199.2685	-0.5914	-3.0421	79.3895	25.7623	-201.1299	73.8738	25.2115	-197.407
2.416	77.7074	26.1329	-200.2691	-0.4964	-3.0367	80.6314	26.4408	-201.8616	74.7834	25.825	-198.6767
2.432	78.5564	26.3875	-201.4248	-0.549	-3.1014	81.2329	26.4952	-203.0634	75.8799	26.2798	-199.7862
2.448	79.0143	26.6623	-202.7447	-0.5709	3.1217	81.6044	26.6108	-204.4084	76.4242	26.7138	-201.0811
2.464	79.0571	26.9306	-203.9963	-0.5753	3.011	81.8781	26.5601	-205.8412	76.236	27.3011	-202.1514
2.48	79.907	26.4894	-204.9375	-0.5759	3.0845	82.8464	26.3213	-206.8494	76.9676	26.6574	-203.0255
2.496	79.7993	26.9561	-205.7622	-0.6053	3.1156	82.6727	26.8815	-207.7513	76.9259	27.0307	-203.7732
2.512	80.5809	27.0492	-207.4399	-0.6695	-2.9941	82.7387	27.3698	-209.1662	78.4232	26.7286	-205.7135
2.528	80.3757	27.1431	-208.441	-0.7595	-3.1315	82.3559	27.163	-210.3213	78.3954	27.1232	-206.5608
2.544	80.2468	27.3524	-209.3095	-0.7429	3.1224	82.4716	27.3097	-211.353	78.0221	27.395	-207.266
2.56	80.1114	26.854	-210.0428	-0.9103	-2.8058	82.1085	27.551	-212.7655	78.1143	26.1569	-207.3201
2.576	80.1098	28.1619	-211.2002	-1.0675	-2.7148	81.5434	28.8139	-214.0608	78.6762	27.51	-208.3396
2.592	80.707	27.7306	-212.1087	-1.0236	-2.8557	82.3175	28.204	-214.8638	79.0966	27.2573	-209.3536
2.608	80.5288	27.86	-212.7065	-0.9232	-2.6535	82.4715	28.8915	-215.6146	78.5861	26.8285	-209.7985
2.624	80.7227	28.1292	-213.6125	-0.8633	-2.7449	83.2445	29.1858	-216.8098	78.2008	27.0727	-210.4153
2.64	80.0948	28.4357	-214.4984	-1.0017	-2.698	81.955	29.3196	-217.718	78.2346	27.5519	-211.2788
2.656	80.5638	28.4583	-215.864	-1.0061	-2.4993	82.2383	29.7109	-219.1646	78.8894	27.2057	-212.5635
2.672	79.6968	26.9825	-216.9926	-1.1318	-2.6138	81.1038	27.8028	-220.461	78.2899	26.1623	-213.5243
2.688	79.7316	27.2134	-218.0446	-0.9496	-2.492	81.662	28.6797	-221.4317	77.8011	25.7471	-214.6575
2.704	79.1792	27.1669	-219.7323	-0.8961	-2.4552	81.2324	28.8491	-223.0507	77.1261	25.4846	-216.4139
2.72	78.9383	26.9576	-220.46	-0.8853	-2.5997	81.2135	28.3272	-223.7074	76.6631	25.588	-217.2127
2.736	79.4163	27.2351	-221.3926	-1.0475	-2.4391	80.7486	28.3628	-224.4182	78.0841	26.1074	-218.367
2.752	78.4576	27.1896	-222.4223	-0.9729	-2.5547	80.2055	28.3522	-225.5043	76.7097	26.0271	-219.3403
2.768	78.3488	27.2023	-223.2236	-0.9721	-2.4774	80.0676	28.5478	-226.4228	76.63	25.8569	-220.0244
2.784	76.883	27.9334	-224.4278	-1.0624	-2.0684	77.7004	29.4382	-227.5007	76.0656	26.4287	-221.3549
2.8	77.0734	27.7501	-225.5604	-1.1081	-2.0636	77.8251	29.1499	-228.746	76.3217	26.3503	-222.3747
2.816	76.7091	27.482	-226.8258	-1.0987	-2.0752	77.5162	28.9441	-230.0967	75.9019	26.0199	-223.555
2.832	76.3858	28.076	-228.0528	-1.0953	-2.1368	77.3261	29.5562	-231.4586	75.4455	26.5958	-224.647
2.848	76.5717	28.1118	-229.1154	-1.1339	-2.2339	77.4801	29.2747	-232.2757	75.6633	26.9488	-225.9552
2.864	76.3983	28.2269	-230.0502	-1.1947	-2.0623	76.974	29.3022	-233.1387	75.8227	27.1516	-226.9617
2.88	75.5308	27.4638	-230.4707	-1.3853	-2.6451	76.0385	27.7389	-233.5473	75.0231	27.1888	-227.3942
2.896	75.6194	27.2543	-231.8822	-1.3946	-2.0479	75.8949	27.7873	-235.2528	75.3439	26.7213	-228.5116
2.912	76.0046	27.8681	-232.8428	-1.2142	-2.2489	76.8384	28.9031	-236.4102	75.1708	26.833	-229.2753
2.928	75.457	28.093	-233.9178	-1.3838	-1.9015	75.6942	28.784	-237.7788	75.2198	27.402	-230.0567
2.944	75.2541	27.1823	-235.2321	-1.3398	-2.1883	75.8098	27.9648	-239.3136	74.6983	26.3997	-231.1505
2.96	74.7187	27.929	-236.0295	-1.3774	-2.3758	75.2545	28.4441	-239.8239	74.183	27.4138	-232.235
2.976	74.995	27.3556	-237.1954	-1.3143	-2.5351	75.8399	27.9418	-241.1161	74.1501	26.7695	-233.2748
2.992	74.8247	27.4692	-238.3266	-1.4229	-2.0892	75.1117	27.9723	-242.2154	74.5377	26.9661	-234.4378
3.008	74.5842	27.4796	-239.2132	-1.2625	-2.2525	75.4156	28.5041	-243.3566	73.7528	26.4551	-235.0698
3.024	74.022	26.7111	-239.8623	-1.4735	-2.3462	74.259	26.9529	-243.33	73.7851	26.4694	-236.3946
3.04	72.2687	26.9977	-240.232	-1.1118	-0.2219	70.6466	27.3637	-243.5965	73.8909	26.6318	-236.8674
3.056	72.3976	26.9069	-241.5416	-1.0365	-0.1262	70.3182	27.1708	-245.0843	74.477	26.6431	-237.9989
3.072	72.0346	26.9581	-242.0705	-1.1135	-0.0585	70.5444	27.0454	-245.1042	73.5249	26.8707	-239.0367
3.088	73.1419	26.4165	-243.008	-1.2062	0.0311	71.869	26.3769	-246.3447	74.4148	26.4562	-239.6713
3.104	71.2869	26.4352	-244.3496	-1.0908	-0.0417	69.7577	26.4989	-247.2896	72.816	26.3714	-241.4096
3.12	71.1665	26.1402	-245.5754	-1.018	-0.0629	69.3766	26.2528	-248.4825	72.9564	26.0275	-242.6682
3.136	72.1206	25.9324	-245.7693	-1.0464	0.1152	70.4298	25.7368	-248.7124	73.8115	26.1281	-242.8263
3.152	71.3554	25.9116	-246.9958	-1.0483	0.2042	69.5801	25.544	-250.1442	73.1308	26.2792	-243.8475
3.168	71.184	25.2867	-247.6511	-0.8974	0.2575	69.2068	24.766	-250.2137	73.1613	25.8075	-245.0885

Mal1

time	pos(x)	pos(y)	pos(z)	el	az	x1	y1	z1	x2	y2	z2
3.184	70.9003	25.1518	-248.8527	-1.0007	0.1051	69.1032	24.9621	-251.6712	72.6974	25.3414	-246.0342
3.2	70.817	25.0066	-249.3923	-1.023	0.1367	68.7258	24.7189	-252.8523	72.9081	25.2942	-245.9323
3.216	71.3225	24.8771	-249.9711	-0.9329	0.1102	69.2551	24.6484	-252.7772	73.3899	25.1058	-247.165
3.232	71.3482	24.8059	-251.1413	-0.9928	0.2507	69.2898	24.2788	-254.3989	73.4066	25.3331	-247.8837
3.248	71.2556	24.4716	-252.7135	-0.9531	0.269	69.1639	23.895	-255.7673	73.3472	25.0482	-249.6596
3.264	71.4002	24.6899	-254.0425	-1.1382	0.4103	70.1054	24.1266	-257.1002	72.6949	25.2531	-250.9848
3.28	70.615	24.1861	-254.5472	-0.9063	0.2671	68.5242	23.6141	-257.3145	72.7059	24.7581	-251.7799
3.296	70.4097	24.2825	-255.665	-0.9648	0.3538	68.5042	23.5787	-258.5963	72.3151	24.9864	-252.7338
3.312	70.9597	23.5045	-256.2529	-0.9099	0.3698	68.8786	22.6978	-259.1233	73.0408	24.3111	-253.3824
3.328	69.8247	24.1188	-256.973	-1.1972	1.1587	69.3691	23.0766	-259.875	70.2803	25.1611	-254.071
3.344	71.8049	23.9592	-258.0492	-1.2468	0.8919	71.0699	23.0482	-261.5349	72.5398	24.8701	-254.5634
3.36	71.1676	23.7196	-259.3701	-1.1393	1.0664	70.5413	22.585	-262.1849	71.7939	24.8541	-256.5553
3.376	72.2557	24.6112	-260.8315	-1.033	1.2	71.6966	23.1732	-263.4185	72.8147	26.0492	-258.2446
3.392	71.2587	24.0005	-261.835	-1.0586	1.2843	70.8732	22.692	-264.2612	71.6442	25.309	-259.4088
3.408	72.1374	24.2317	-262.7532	-0.9241	1.0361	71.2669	22.7618	-265.016	73.0079	25.7015	-260.4905
3.424	72.7393	23.6778	-264.2154	-1.013	1.4034	72.4458	21.9408	-267.0388	73.0328	25.4147	-261.3921
3.44	72.6063	23.8551	-265.6725	-1.0156	1.2475	72.0485	22.1903	-268.5028	73.164	25.5199	-262.8421
3.456	72.1473	23.6408	-265.9089	-1.0103	1.4568	71.9434	21.8606	-268.7641	72.3512	25.4211	-263.0536
3.472	72.7817	23.6015	-266.8307	-1.0986	1.6204	72.8595	22.0364	-269.8986	72.7039	25.1665	-263.7628
3.488	73.3956	23.879	-268.4123	-1.1612	1.4287	73.231	22.7283	-271.0899	73.5602	25.0298	-265.7347
3.504	73.0699	24.2552	-270.0015	-0.9636	2.1412	74.0613	22.7097	-272.6445	72.0785	25.8006	-267.3584
3.52	72.7859	23.6156	-271.1048	-1.1303	1.9962	73.3543	22.3613	-274.0263	72.2176	24.87	-268.1833
3.536	72.973	23.691	-272.1686	-1.0612	1.8606	73.4779	21.9977	-275.3304	72.4681	25.3842	-269.0069
3.552	73.1226	22.1603	-271.5638	-1.3117	2.6595	73.8961	21.7555	-274.8572	72.3491	22.565	-268.2704
3.568	73.4314	22.5689	-272.5916	-1.2222	2.5016	74.321	21.9066	-275.6431	72.5418	23.2313	-269.54
3.584	73.653	22.5365	-273.1364	-1.1498	2.2568	74.3851	21.6421	-275.7178	72.9209	23.4309	-270.5551
3.6	74.5555	22.0512	-274.732	-1.0884	2.2478	75.4444	20.9452	-277.4415	73.6666	23.1573	-272.0224
3.616	75.432	21.7906	-275.0194	-1.0841	2.8519	76.7346	21.4024	-277.5884	74.1293	22.1789	-272.4504
3.632	76.1124	21.1219	-275.682	-1.25	2.9207	77.1285	20.8937	-278.8169	75.0962	21.3501	-272.5471
3.648	76.5975	22.1058	-277.395	-1.1033	2.9385	78.276	21.7601	-280.7897	74.919	22.4516	-274.0004
3.664	77.0828	21.8903	-278.2533	-1.1637	2.8957	78.4657	21.5432	-281.5603	75.6998	22.2374	-274.9463
3.68	77.0802	22.4572	-279.8496	-1.1193	-3.1007	78.8974	22.5315	-283.6005	75.263	22.3829	-276.0986
3.696	76.9118	22.5156	-280.8341	-1.02	3.0244	78.781	22.2955	-283.8983	75.0425	22.7356	-277.77
3.712	76.9801	22.4786	-282.0283	-0.8272	-3.0922	79.8727	22.6217	-285.1773	74.0875	22.3355	-278.8793
3.728	75.8758	22.5368	-283.6365	-0.9145	-3.1012	78.3345	22.6362	-286.8314	73.4171	22.4374	-280.4416
3.744	76.6284	22.2592	-284.1716	-0.9841	-3.0537	78.8658	22.4564	-287.55	74.3911	22.062	-280.7932
3.76	76.5448	22.2787	-285.1562	-0.8358	-3.0918	79.4188	22.4219	-288.3395	73.6708	22.1355	-281.9729
3.776	76.4396	22.9716	-286.6075	-0.8603	3.1319	78.9699	22.9472	-289.5485	73.9093	22.9961	-283.6665
3.792	76.6053	22.6207	-287.3905	-1.002	3.0704	78.5597	22.4812	-290.4559	74.6508	22.7601	-284.3251
3.808	76.9411	23.1257	-288.2417	-1.0215	3.1169	79.0097	23.0746	-291.6219	74.8725	23.1769	-284.8614
3.824	78.0041	23.8283	-289.7741	-0.9437	-3.0634	80.484	24.0226	-293.2066	75.5242	23.634	-286.3416
3.84	77.2532	23.3682	-290.7117	-0.866	-3.0951	79.9731	23.4947	-293.9131	74.5334	23.2418	-287.5103
3.856	77.302	22.8723	-291.5705	-0.9764	-3.0644	79.5343	23.045	-294.8824	75.0698	22.6997	-288.2586
3.872	77.249	23.8064	-292.9531	-0.9946	3.0187	79.3663	23.5449	-296.2367	75.1316	24.068	-289.6694
3.888	76.9981	23.1226	-293.3494	-1.0537	-2.882	78.9467	23.6401	-296.8947	75.0495	22.6052	-289.8041
3.904	77.3254	23.7727	-295.1391	-1.0268	-2.8836	79.444	24.3319	-298.7614	75.2069	23.2136	-291.5167
3.92	77.0994	23.5571	-295.9438	-1.0219	-2.986	79.1916	23.8852	-299.4064	75.0073	23.2289	-292.4812
3.936	77.7111	23.8185	-297.1316	-1.086	-2.6745	79.4623	24.7016	-300.8554	75.9599	22.9354	-293.4079
3.952	77.5828	24.2199	-298.2007	-1.0253	-3.1131	79.5495	24.276	-301.4424	75.6161	24.1638	-294.9591
3.968	77.4125	23.7389	-298.8857	-1.0349	-3.0033	79.1559	23.9816	-301.8499	75.669	23.4962	-295.9215
3.984	77.5917	24.1835	-300.2586	-1.0089	-2.8703	79.7258	24.7771	-303.7768	75.4577	23.59	-296.7404
4	77.2795	23.9976	-300.9985	-1.0224	-2.9198	79.29	24.4509	-304.3719	75.2691	23.5443	-297.6251
4.016	77.3989	22.9497	-302.2969	-1.0761	-2.753	79.1622	23.6716	-305.829	75.6356	22.2278	-298.7647
4.032	76.8547	23.3826	-303.5076	-1.2756	-2.498	77.6392	23.9711	-306.7329	76.0701	22.794	-300.2823
4.048	76.3661	23.7346	-304.5847	-1.1261	-2.5233	77.7743	24.7362	-308.2114	74.9579	22.7329	-300.958
4.064	77.494	23.2057	-305.7716	-0.9851	-2.9068	79.6905	23.7311	-309.1765	75.2974	22.6804	-302.3667
4.08	76.9158	23.0349	-306.79	-1.0999	-2.8815	78.5379	23.4665	-310.0873	75.2937	22.6032	-303.4927
4.096	75.5541	23.1646	-307.9555	-1.3458	-1.2298	75.2586	23.9973	-311.8161	75.8496	22.3319	-304.0949
4.112	75.6172	22.6123	-308.6578	-1.4576	-1.5292	75.6022	22.9723	-311.8275	75.6322	22.2524	-305.4882
4.128	75.2816	22.9458	-309.6499	-1.4267	-1.1602	75.0715	23.4285	-313.2776	75.4918	22.4631	-306.0223
4.144	75.5689	22.1972	-310.2836	-1.4884	-2.5659	75.8073	22.3519	-313.7267	75.3305	22.0424	-306.8405
4.16	75.4314	22.5462	-311.6606	-1.4424	-2.1681	75.6855	22.9197	-315.1603	75.1773	22.1726	-308.161
4.176	74.637	21.9149	-312.6452	-1.4521	-2.7231	75.0317	22.0905	-316.2665	74.2423	21.7394	-309.024
4.192	74.8062	21.7006	-313.5822	-1.5533	-2.6086	74.8601	21.7324	-317.1622	74.7523	21.6688	-310.0021
4.208	74.2099	21.2755	-314.477	-1.4279	-2.9205	74.733	21.3931	-318.2023	73.6869	21.1579	-310.7518
4.224	74.8759	21.8905	-315.9262	-1.3494	-3.0286	75.6423	21.9775	-319.3525	74.1095	21.8035	-312.4999

Ma11											
time	pos(x)	pos(y)	pos(z)	el	az	x1	y1	z1	x2	y2	z2
4.24	74.2016	21.3112	-316.3734	-1.3988	-3.0832	74.8239	21.3475	-319.9609	73.5794	21.2748	-312.786
4.256	73.3534	20.4719	-317.6377	-1.3707	1.5738	73.3556	19.771	-321.094	73.3513	21.1728	-314.1814
4.272	72.9069	20.064	-318.139	-1.3574	0.8056	72.4246	19.5618	-321.3524	73.3893	20.5662	-314.9257
4.288	72.5661	20.1528	-318.7544	-1.297	0.4287	71.7816	19.7942	-321.8254	73.3506	20.5113	-315.6835
4.304	72.2162	19.8299	-320.1076	-1.3046	0.3881	71.4292	19.5082	-323.2264	73.0032	20.1517	-316.9888
4.32	72.0963	19.5205	-320.8521	-1.1912	1.0242	71.5558	18.6322	-323.4584	72.6368	20.4088	-318.2458
4.336	72.2876	19.1574	-321.7599	-1.3248	0.8605	71.7767	18.5633	-324.8811	72.7986	19.7515	-318.6388
4.352	72.4881	19.2216	-322.7097	-1.3367	0.8942	72.0912	18.7275	-325.3673	72.8849	19.7157	-320.0522
4.368	71.9438	18.9659	-323.0021	-1.3081	0.7642	71.3975	18.4422	-325.8157	72.4901	19.4895	-320.1884
4.384	71.498	18.5841	-323.8234	-1.1315	0.4528	70.3876	18.0439	-326.4509	72.6083	19.1244	-321.1958
4.4	70.7963	18.5453	-324.4874	-1.1901	0.3646	69.9465	18.2209	-326.76	71.6461	18.8696	-322.2148

Manta											
time	pos(x)	pos(y)	pos(z)	el	az	x1	y1	z1	x2	y2	z2
0	0	0	0	0.09	0.0405	-3.4739	-0.1408	0.3137	3.4739	0.1408	-0.3137
0.016	-0.0972	0.6343	-3.8317	0.203	0.072	-3.2798	0.4046	-3.1749	3.0855	0.864	-4.4885
0.032	-0.3075	1.9489	-6.7663	0.1452	0.178	-3.517	1.3714	-6.2895	2.902	2.5264	-7.2432
0.048	-0.8072	1.9042	-11.0451	0.5128	0.4286	-2.7854	1.0004	-9.8205	1.171	2.8081	-12.2696
0.064	-0.7776	2.2042	-13.8575	0.9456	1.0413	-1.3352	1.2513	-12.3279	-0.22	3.1572	-15.3871
0.08	-2.3135	3.3404	-16.7415	0.6668	2.1481	-1.3442	1.8521	-15.3435	-3.2829	4.8287	-18.1395
0.096	-2.8279	3.0002	-19.8054	0.4572	2.6712	-0.6719	1.904	-18.6154	-4.9839	4.0965	-20.9955
0.112	-3.42	2.8542	-22.2527	0.4346	2.8665	-0.7622	2.104	-20.9708	-6.0778	3.6043	-23.5347
0.128	-4.1728	2.6317	-24.9338	0.4423	3.1416	-1.1919	2.6316	-23.522	-7.1538	2.6317	-26.3457
0.144	-4.4182	3.1393	-26.6077	0.2114	3.1386	-1.1371	3.1296	-25.9035	-7.6993	3.149	-27.312
0.16	-4.8829	3.1918	-27.9943	0.1963	-3.0806	-1.0779	3.4241	-27.2361	-8.6878	2.9595	-28.7525
0.176	-5.0114	3.0903	-30.5806	0.1577	-3.1157	-1.6312	3.1779	-30.0429	-8.3916	3.0026	-31.1184
0.192	-5.6368	3.3289	-31.7837	0.1226	-3.0454	-2.5654	3.6252	-31.4036	-8.7083	3.0327	-32.1638
0.208	-5.9522	3.4721	-33.8469	0.0453	-3.1053	-2.1727	3.6095	-33.6754	-9.7316	3.3348	-34.0185
0.224	-6.7817	4.1114	-36.6738	0.0798	3.0733	-3.0345	3.8549	-36.3733	-10.529	4.3679	-36.9743
0.24	-7.006	4.4001	-36.8323	-0.0901	2.9618	-3.4203	3.7484	-37.1614	-10.5916	5.0518	-38.5032
0.256	-7.0424	4.433	-39.7849	0.2457	2.9129	-3.0471	3.5033	-38.7561	-11.0376	5.3628	-40.8136
0.272	-7.1448	4.4002	-41.8159	0.3614	2.9354	-3.7276	3.6854	-40.4963	-10.5621	5.1149	-43.1355
0.288	-7.0102	4.3377	-43.7813	0.6107	2.9494	-4.337	3.8176	-41.8749	-9.6834	4.8578	-45.6877
0.304	-6.6573	5.1028	-44.4221	0.7788	2.6823	-4.7084	4.1388	-42.2763	-8.6063	6.0667	-46.5678
0.32	-6.7273	5.6455	-45.3888	0.9225	2.4086	-5.5355	4.5725	-43.272	-7.9191	6.7184	-47.5057
0.336	-5.1259	5.9477	-46.7921	1.1474	1.9297	-4.7495	4.9444	-44.4146	-5.5023	6.951	-49.1696
0.352	-3.7414	6.0532	-47.2752	0.7784	0.6382	-5.2286	4.95	-45.4491	-2.2541	7.1564	-49.1013
0.368	-2.7712	6.4228	-47.5668	0.7616	0.6153	-4.1597	5.4415	-45.9458	-1.3828	7.4041	-49.1878
0.384	-2.3371	6.4116	-48.7747	0.5901	0.3141	-4.6542	5.6589	-47.1431	-0.0201	7.1643	-50.4063
0.4	-0.8205	6.5985	-49.7721	0.4794	0.2133	-3.6653	5.9824	-48.2588	2.0243	7.2146	-51.2853
0.416	-0.6944	6.5485	-49.9927	0.125	0.3227	-3.7257	5.5347	-49.5912	2.337	7.5622	-50.3942
0.432	-0.3693	6.3912	-50.9084	0.0245	0.2916	-3.8886	5.3349	-50.8184	3.1499	7.4476	-50.9984
0.448	0.6842	6.8566	-51.6025	-0.0177	0.243	-3.27	5.8763	-51.6748	4.6383	7.368	-51.5303
0.464	0.6348	6.8514	-52.8693	-0.1517	0.4078	-2.6966	5.4122	-53.4241	3.9663	8.2907	-52.3145
0.48	1.777	7.6022	-52.748	-0.044	0.0886	-2.8826	7.1883	-52.954	6.4366	8.0161	-52.542
0.496	1.8459	7.4291	-53.9198	-0.1654	0.2075	-1.8019	6.661	-54.5422	5.4937	8.1972	-53.2975
0.512	2.0046	6.8469	-54.8597	-0.2376	0.2312	-1.7874	5.9543	-55.8032	5.7966	7.7395	-53.9162
0.528	2.2478	7.2522	-55.1128	-0.2683	0.2259	-1.3549	6.4243	-56.129	5.8505	8.0802	-54.0966
0.544	2.1414	7.4418	-55.6235	-0.2959	0.1949	-1.3495	6.7526	-56.7082	5.6322	8.131	-54.5388
0.56	2.2913	7.5546	-56.7953	-0.2539	0.1566	-1.0031	7.0345	-57.6607	5.5856	8.0747	-55.9298
0.576	2.7671	7.9735	-58.1621	-0.2055	0.1587	-1.1707	7.3433	-58.9935	6.7049	8.6038	-57.3306
0.592	2.533	8.0887	-59.2469	-0.2224	0.1365	-0.6954	7.6452	-59.984	5.7614	8.5322	-58.5099
0.608	3.04	8.6626	-60.056	-0.1759	0.104	-0.7406	8.2678	-60.7316	6.8206	9.0574	-59.3804
0.624	3.2953	8.0619	-61.1745	-0.2406	0.1812	-0.3079	7.4018	-62.0732	6.8984	8.722	-60.2758
0.64	3.1517	8.5187	-62.1903	-0.1436	0.0607	-1.1277	8.2587	-62.8104	7.4311	8.7788	-61.5702
0.656	3.4854	8.6883	-62.7532	-0.0688	0.1927	-0.2727	7.9551	-63.017	7.2435	9.4214	-62.4894
0.672	4.2027	8.9821	-64.7343	0.074	0.0938	0.9412	8.6753	-64.4914	7.4642	9.289	-64.9772
0.688	3.7514	9.8147	-66.5259	0.1649	0.2689	0.6838	8.9694	-65.9965	6.819	10.66	-67.0553
0.704	4.2306	9.9869	-67.8463	0.3519	0.1022	0.4578	9.6	-66.4537	8.0033	10.3738	-69.2389
0.72	4.1048	9.8882	-69.4555	0.363	0.1944	0.6559	9.209	-68.1204	7.5537	10.5673	-70.7905
0.736	3.1663	10.4624	-70.8864	0.6106	0.4126	0.9006	9.4705	-69.1556	5.432	11.4542	-72.6171
0.752	3.2745	11.2991	-71.1476	0.7066	0.3701	1.0654	10.4419	-69.125	5.4835	12.1563	-73.1702
0.768	3.1744	11.7445	-72.9953	0.7753	0.5136	1.2896	10.6814	-70.8745	5.0593	12.8076	-75.116
0.784	2.1417	11.3883	-74.1579	1.0564	0.4468	0.8376	10.7634	-71.5989	3.4459	12.0132	-76.7169
0.8	1.1116	12.4404	-74.931	1.1147	1.2689	0.776	11.3626	-72.6298	1.4472	13.5182	-77.2321

Ma12

time	pos(x)	pos(y)	pos(z)	el	az	x1	y1	z1	x2	y2	z2
0.816	0.9579	12.2445	-76.3099	1.3247	1.3531	0.8103	11.5773	-73.5898	1.1055	12.9117	-79.03
0.832	-0.0377	12.1792	-77.6463	1.2407	2.3696	0.5998	11.5586	-75.0493	-0.6752	12.7998	-80.2433
0.848	-0.5125	12.4131	-78.8626	0.8928	2.5006	0.8252	11.4151	-76.7904	-1.8501	13.4112	-80.9349
0.864	-1.9316	12.639	-79.3203	0.9568	2.7807	-0.4021	12.0617	-77.001	-3.4611	13.2162	-81.6396
0.88	-2.0895	12.1493	-80.15	1.0073	2.9121	-0.6422	11.8112	-77.7974	-3.5369	12.4874	-82.5026
0.896	-2.6762	11.8072	-81.1727	0.8318	3.0448	-0.4379	11.59	-78.7051	-4.9145	12.0244	-83.6404
0.912	-2.6044	12.0581	-81.9811	0.6984	-3.1285	-0.0075	12.0922	-79.8005	-5.2012	12.024	-84.1616
0.928	-3.1888	12.0187	-82.4267	0.6269	-3.1345	0.0355	12.0417	-80.0909	-6.413	11.9957	-84.7624
0.944	-4.2553	12.7006	-82.8952	0.4795	-3.129	-0.9496	12.7422	-81.1761	-7.561	12.6589	-84.6143
0.96	-4.0399	12.5104	-84.1404	0.5906	-3.015	-0.7847	12.9249	-81.9405	-7.295	12.096	-86.3403
0.976	-4.378	13.35	-83.9716	0.1753	3.0631	-0.5722	13.0505	-83.2954	-8.1837	13.6495	-84.6478
0.992	-4.2432	13.2167	-84.2742	0.1317	3.1264	-0.6536	13.1621	-83.7985	-7.8329	13.2712	-84.7499
1.008	-5.1453	13.6907	-85.8113	0.2681	-3.1279	-1.8558	13.7356	-84.9077	-8.4347	13.6457	-86.7149
1.024	-5.1106	14.0831	-86.1565	0.0954	3.0175	-1.5734	13.6418	-85.8153	-8.6477	14.5245	-86.4978
1.04	-5.193	14.0415	-87.3757	0.0505	3.0331	-1.4324	13.6317	-87.1844	-8.9537	14.4512	-87.5671
1.056	-5.4396	14.568	-87.7603	-0.0579	3.1351	-1.9895	14.5456	-87.9602	-8.8897	14.5905	-87.5603
1.072	-6.0122	15.1743	-88.9566	-0.0794	3.1157	-2.2468	15.0769	-89.2562	-9.7775	15.2717	-88.657
1.088	-5.6646	15.1258	-90.2139	-0.1781	-2.9349	-2.793	15.7279	-90.7422	-8.5361	14.5237	-89.6857
1.104	-6.0415	15.3471	-91.0756	-0.2712	-2.9224	-3.5504	15.9021	-91.7854	-8.5325	14.792	-90.3659
1.12	-7.0541	15.5516	-92.3066	-0.1101	-2.9481	-3.9966	16.1508	-92.6509	-10.1117	14.9524	-91.9622
1.136	-7.3896	16.2723	-93.9761	-0.164	-3.104	-4.0691	16.3973	-94.5259	-10.7102	16.1473	-93.4263
1.152	-7.6033	15.9554	-95.1891	-0.1773	-3.0166	-4.5499	16.3391	-95.7404	-10.6568	15.5718	-94.6377
1.168	-7.5976	16.1049	-96.2365	-0.2334	-3.0238	-4.1443	16.5135	-97.0633	-11.051	15.6963	-95.4096
1.184	-7.481	16.3505	-97.7049	-0.1866	-3.036	-3.9769	16.722	-98.3703	-10.985	15.979	-97.0396
1.2	-10.0061	16.7229	-99.8355	-0.2019	-3.0928	-6.7118	16.884	-100.5108	-13.3004	16.5619	-99.1603
1.216	-10.8318	17.4181	-101.2878	-0.2228	-3.1399	-6.791	17.4247	-102.2034	-14.8726	17.4114	-100.3723
1.232	-9.8008	17.4586	-102.5342	-0.2431	-3.0506	-5.8281	17.821	-103.5237	-13.7735	17.0961	-101.5446
1.248	-11.439	17.5358	-103.9988	-0.3577	3.0324	-7.5438	17.1088	-105.4635	-15.3342	17.9628	-102.5342
1.264	-11.7014	17.9524	-105.4225	-0.3036	2.9745	-7.6393	17.2672	-106.713	-15.7636	18.6376	-104.1319
1.28	-12.7243	18.8032	-107.0437	-0.2654	2.9503	-8.4398	17.9737	-108.2299	-17.0087	19.6328	-105.8576
1.296	-13.4208	19.1474	-108.7606	-0.2645	2.9895	-9.0249	18.4735	-109.9651	-17.8167	19.8213	-107.5561
1.312	-14.559	18.8086	-111.9624	0.0079	3.0176	-10.081	18.2506	-111.9268	-19.0369	19.3666	-111.998
1.328	-13.8733	18.4891	-113.5874	0.233	3.0892	-10.0222	18.2869	-112.6725	-17.7244	18.6912	-114.5024
1.344	-14.5598	19.0291	-115.4933	0.213	3.0143	-9.8761	18.4294	-114.4721	-19.2434	19.6287	-116.5146
1.36	-14.9383	19.6819	-117.4196	0.2557	2.9558	-10.1973	18.7909	-116.1587	-19.6793	20.5729	-118.6804
1.376	-14.9171	20.4584	-119.0509	0.4016	2.7619	-11.4266	19.0655	-117.4547	-18.4076	21.8512	-120.647
1.392	-14.9891	20.7097	-120.4952	0.5357	2.7729	-12.0321	19.567	-118.6132	-17.9461	21.8523	-122.3772
1.408	-14.5504	21.0235	-122.5162	1.0401	2.4281	-13.3022	19.9431	-119.703	-15.7985	22.1038	-125.3294
1.424	-14.3079	21.1649	-124.136	1.0442	2.5869	-12.8672	20.2721	-121.2207	-15.7487	22.0576	-127.0513
1.44	-12.4146	20.8647	-125.7027	1.4193	1.0094	-12.6696	20.4593	-122.5664	-12.1596	21.27	-128.839
1.456	-12.1522	21.3619	-126.9991	1.3	0.7727	-12.7488	20.7802	-123.9977	-11.5555	21.9436	-130.0005
1.472	-9.2038	21.31	-128.1846	0.7835	0.0176	-12.0372	21.2602	-125.3616	-6.3704	21.3599	-131.0077
1.488	-8.3758	22.0616	-129.171	0.8833	0.2298	-10.3669	21.5959	-126.6809	-6.3848	22.5273	-131.6612
1.504	-8.7756	21.8708	-129.4652	0.7813	0.5182	-10.5894	20.8366	-127.3941	-6.9617	22.9049	-131.5363
1.52	-7.7784	22.2311	-129.5937	0.5347	0.6295	-9.8866	20.6957	-128.0489	-5.6703	23.7665	-131.1384
1.536	-7.4614	22.9303	-130.388	0.5008	0.3684	-10.2418	21.8571	-128.7568	-4.6811	24.0035	-132.0192
1.552	-6.5334	23.0286	-131.4074	0.3905	0.4031	-9.7321	21.6646	-129.9758	-3.3347	24.3926	-132.839
1.568	-5.8128	20.8342	-131.2276	0.2363	0.1563	-9.4292	20.2643	-130.3458	-2.1964	21.4042	-132.1093
1.584	-6.0835	22.0034	-133.2244	0.2648	0.2468	-9.2959	21.1941	-132.3261	-2.8711	22.8128	-134.1227
1.6	-5.5496	22.1264	-133.3808	0.1817	0.2107	-9.0587	21.3759	-132.7214	-2.0405	22.8769	-134.0403
1.616	-5.5553	22.3086	-134.2252	0.1449	0.1299	-9.3366	21.8148	-133.6687	-1.774	22.8024	-134.7817
1.632	-5.434	22.5162	-134.7736	-0.0774	0.2648	-8.5288	21.6771	-135.0221	-2.3393	23.3553	-134.525
1.648	-5.2658	22.6033	-136.0964	-0.0222	0.256	-8.1046	21.8604	-136.1616	-2.427	23.3462	-136.0313
1.664	-5.0475	23.2787	-136.8589	0.1002	0.2205	-8.4325	22.5198	-136.5101	-1.6625	24.0375	-137.2077
1.68	-4.8168	23.4325	-137.9637	0.011	0.0893	-8.4921	23.1035	-137.9232	-1.1416	23.7614	-138.0042
1.696	-3.5148	22.9205	-139.2719	-0.0353	0.222	-7.4224	22.0384	-139.4135	0.3928	23.8026	-139.1303
1.712	-3.6827	23.2615	-140.6846	-0.0002	0.28	-6.9507	22.3218	-140.6854	-0.4147	24.2011	-140.6839
1.728	-3.9527	23.9229	-141.4936	-0.0264	0.0938	-7.7652	23.5643	-141.5949	-0.1401	24.2814	-141.3924
1.744	-2.804	23.9805	-143.0448	-0.1385	0.1888	-6.1759	23.3361	-143.5235	0.5679	24.6249	-142.5662
1.76	-3.5902	23.9576	-144.7345	-0.0866	0.1922	-7.2472	23.246	-145.058	0.0669	24.6691	-144.411
1.776	-2.3859	24.5106	-147.0001	0.1049	0.2029	-6.0311	23.7606	-146.6084	1.2592	25.2607	-147.3918
1.792	-1.8769	24.307	-148.381	-0.0523	0.133	-5.8084	23.7809	-148.5885	2.0546	24.8332	-148.1736
1.808	-2.0465	24.9603	-149.9622	0.1988	0.1061	-5.864	24.5537	-149.1889	1.771	25.367	-150.7356
1.824	-2.0315	25.8799	-152.111	0.2796	0.133	-5.6102	25.4012	-151.0742	1.5472	26.3587	-153.1477
1.84	-1.1798	25.1946	-152.7227	0.3156	-0.061	-4.7826	25.4147	-151.5441	2.4229	24.9746	-153.9014
1.856	-1.8325	25.7111	-155.168	0.5514	0.0768	-5.3865	25.4378	-152.976	1.7215	25.9845	-157.3601

Ma12

time	pos(x)	pos(y)	pos(z)	el	az	x1	y1	z1	x2	y2	z2
1.872	-1.3297	25.7366	-156.7155	0.4678	-0.1942	-5.1341	26.4849	-154.7565	2.4747	24.9883	-158.6745
1.888	-1.2041	25.8698	-157.9953	0.7108	-0.1149	-4.0842	26.2023	-155.4991	1.676	25.5373	-160.4915
1.904	-2.2979	27.1909	-160.5282	0.8593	0.2045	-4.6487	26.7034	-157.7436	0.0529	27.6785	-163.3129
1.92	-1.8037	26.7692	-161.6907	0.8882	0.1808	-3.9407	26.3785	-159.0186	0.3334	27.1599	-164.3627
1.936	-3.6989	27.2152	-163.7132	1.2956	0.6226	-4.4697	26.6619	-160.3527	-2.928	27.7685	-167.0736
1.952	-2.3721	27.1391	-165.2921	1.2709	0.0054	-3.4221	27.1335	-161.8963	-1.3221	27.1448	-168.688
1.968	-4.0155	27.1521	-166.9422	1.4536	1.7161	-3.9555	26.7424	-163.4265	-4.0754	27.5618	-170.4579
1.984	-4.16	27.6106	-168.2674	1.4905	2.4066	-3.9807	27.4486	-165.2626	-4.3392	27.7726	-171.2721
2	-5.8033	27.6914	-169.0865	1.0157	2.8225	-4.0097	27.0988	-166.0403	-7.5969	28.2841	-172.1326
2.016	-6.2148	27.838	-170.0129	0.96	3.0528	-4.0093	27.6416	-166.8504	-8.4204	28.0345	-173.1754
2.032	-7.0369	27.9028	-171.473	1.1154	2.8995	-5.3544	27.4873	-167.9342	-8.7195	28.3184	-175.0117
2.048	-8.5797	28.8097	-172.3838	0.9211	3.0592	-6.223	28.615	-169.2709	-10.9364	29.0044	-175.4967
2.064	-8.4649	29.0307	-173.6015	0.8192	2.9325	-5.9639	28.5	-170.8658	-10.9659	29.5614	-176.3373
2.08	-9.4489	28.8121	-174.096	0.5866	3.0155	-5.9671	28.3708	-171.7635	-12.9306	29.2534	-176.4285
2.096	-9.7661	29.0212	-175.5466	0.4898	2.9697	-5.4525	28.2725	-173.2126	-14.0797	29.77	-177.8806
2.112	-10.6714	29.8398	-175.7254	0.2839	2.9655	-5.9399	28.9981	-174.3231	-15.4028	30.6815	-177.1277
2.128	-10.5284	29.7894	-176.9709	0.2972	3.014	-6.2448	29.24	-175.648	-14.8121	30.3388	-178.2938
2.144	-10.6919	30.019	-177.3489	0.1358	2.9587	-5.9592	29.1434	-176.6913	-15.4246	30.8946	-178.0065
2.16	-11.3645	29.9333	-178.3402	0.191	3.0599	-6.5285	29.5374	-177.402	-16.2004	30.3293	-179.2784
2.176	-11.2483	30.3491	-179.4353	0.1256	3.1361	-6.5515	30.3234	-178.8424	-15.9452	30.3748	-180.0282
2.192	-11.2443	30.4634	-180.1622	0.1891	3.1117	-6.8178	30.3312	-179.3145	-15.6708	30.5956	-181.01
2.208	-11.955	30.3299	-181.1349	0.1597	3.0188	-7.0853	29.7287	-180.3446	-16.8248	30.931	-181.9253
2.224	-11.4815	29.2148	-182.0441	-0.0168	-3.0496	-6.2785	29.6949	-182.1318	-16.6844	28.7347	-181.9563
2.24	-10.8841	30.1623	-183.3486	-0.0418	3.0698	-6.5688	29.852	-183.5295	-15.1995	30.4727	-183.1678
2.256	-13.212	31.6114	-184.4902	-0.1221	2.9866	-8.5415	30.8815	-185.0703	-17.8826	32.3414	-183.91
2.272	-13.4167	32.2562	-185.4552	-0.1566	2.8363	-8.5352	30.7181	-186.2632	-18.2982	33.7944	-184.6472
2.288	-14.7334	32.4818	-188.1322	-0.0822	2.8878	-9.1273	31.0279	-188.6094	-20.3394	33.9358	-187.655
2.304	-13.697	32.1024	-188.6463	-0.2175	2.8842	-8.8457	30.8256	-189.755	-18.5484	33.3792	-187.5376
2.32	-14.2816	32.0869	-190.5719	-0.2446	2.9299	-8.5789	30.8612	-192.0276	-19.9843	33.3127	-189.1162
2.336	-14.8366	32.2389	-191.7613	-0.3568	2.9342	-10.5542	31.3381	-193.3924	-19.119	33.1398	-190.1302
2.352	-15.0767	31.9778	-193.468	-0.4522	3.1281	-11.427	31.9287	-195.2411	-18.7265	32.0269	-191.6949
2.368	-16.0471	31.744	-195.7583	-0.4573	-3.1033	-12.5511	31.878	-197.4799	-19.543	31.6099	-194.0367
2.384	-16.3406	31.9077	-197.0045	-0.5107	-3.075	-12.8495	32.1403	-198.9648	-19.8317	31.675	-195.0441
2.4	-17.8126	32.5282	-198.7741	-0.4969	-3.1245	-14.0068	32.5931	-200.8382	-21.6183	32.4633	-196.71
2.416	-18.8008	32.5877	-199.9259	-0.4551	-3.0707	-14.587	32.8868	-201.9933	-23.0146	32.2886	-197.8585
2.432	-19.0817	32.4907	-201.7721	-0.4851	-3.1187	-14.8445	32.5877	-204.0062	-23.3189	32.3936	-199.5379
2.448	-19.7952	32.4959	-203.8645	-0.5237	3.1412	-15.9678	32.4944	-206.0746	-23.6225	32.4973	-201.6544
2.464	-20.0259	32.0365	-205.2271	-0.5026	-3.096	-16.2277	32.2099	-207.3171	-23.824	31.863	-203.1371
2.48	-22.5696	32.132	-206.5506	-0.4677	-3.102	-18.4807	32.294	-208.6176	-26.6586	31.97	-204.4836
2.496	-22.8886	32.4334	-209.0186	-0.5525	-3.1291	-19.6143	32.4745	-211.0375	-26.163	32.3924	-206.9998
2.512	-24.1951	31.7879	-210.3643	-0.6069	-3.0214	-20.9806	32.1761	-212.6125	-27.4097	31.3997	-208.1161
2.528	-25.899	31.8441	-212.218	-0.5949	3.0891	-22.3069	31.6554	-214.6519	-29.491	32.0328	-209.7841
2.544	-27.7154	31.7857	-214.5553	-0.6599	-3.079	-24.6102	31.9803	-216.9694	-30.8205	31.5911	-212.1413
2.56	-28.9692	31.8541	-216.3752	-0.7991	-2.881	-26.6407	32.475	-218.8523	-31.2977	31.2332	-213.8982
2.576	-30.8233	32.0327	-218.6578	-0.504	-3.1344	-26.8419	32.0615	-220.8534	-34.8048	32.0039	-216.4622
2.592	-32.0858	31.8803	-219.1194	-0.4982	-3.1003	-27.9921	32.0494	-221.348	-36.1794	31.7111	-216.8909
2.608	-33.5776	31.7191	-221.3031	-0.6723	3.0649	-30.081	31.4504	-224.0947	-37.0742	31.9879	-218.5115
2.624	-34.0853	31.9017	-222.9472	-0.5722	2.8974	-29.6828	30.8048	-225.8693	-38.4878	32.9987	-220.0252
2.64	-35.7284	31.8744	-225.4338	-0.5384	2.9869	-31.7041	31.2469	-227.8665	-39.7527	32.5019	-223.0011
2.656	-38.6545	31.6628	-228.7571	-0.4216	3.0268	-34.8331	31.2222	-230.4822	-42.4759	32.1034	-227.0319
2.672	-39.9336	31.7164	-230.5092	-0.5633	3.079	-36.5797	31.5061	-232.6313	-43.2875	31.9268	-228.387
2.688	-41.2354	31.8729	-232.0871	-0.3695	2.8626	-37.2456	30.7299	-233.6943	-45.2251	33.016	-230.4798
2.704	-43.0315	31.2539	-234.9877	-0.3382	3.0328	-38.2268	30.729	-236.6879	-47.8362	31.7788	-233.2875
2.72	-43.3733	31.3308	-236.9051	-0.0685	2.9433	-37.5864	30.1678	-237.3101	-49.1601	32.4937	-236.5002
2.736	-44.1169	29.6891	-239.2294	0.1004	-3.079	-38.9389	30.0134	-238.7069	-49.295	29.3648	-239.7519
2.752	-45.0706	30.0195	-242.0404	0.2304	3.0582	-39.9044	29.5876	-240.8245	-50.2368	30.4514	-243.2563
2.768	-45.9838	30.0792	-244.0468	0.3496	3.1326	-41.9578	30.043	-242.5791	-50.0097	30.1154	-245.5144
2.784	-45.3816	29.7031	-245.64	0.6653	-2.9674	-42.5716	30.1976	-243.4014	-48.1915	29.2086	-247.8785
2.8	-44.6347	29.2927	-248.0572	1.0417	-2.8786	-42.9786	29.7385	-245.124	-46.2908	28.8468	-250.9903
2.816	-43.4155	29.0054	-250.3639	1.3129	-2.8308	-42.515	29.2946	-246.7789	-44.316	28.7162	-253.9489
2.832	-40.9647	28.7321	-251.8705	1.3838	-1.3369	-41.115	29.3627	-248.4448	-40.8145	28.1016	-255.2962
2.848	-40.0724	29.0692	-253.8608	1.3275	-0.4283	-40.8082	29.4051	-250.6026	-39.3366	28.7333	-257.1191
2.864	-38.0138	28.6764	-254.5945	0.7603	-0.2996	-40.8881	29.5643	-251.7333	-35.1395	27.7884	-257.4557
2.88	-37.8895	29.1502	-254.8554	0.8265	-0.0844	-40.2984	29.354	-252.2305	-35.4806	28.9465	-257.4803
2.896	-36.498	28.6798	-255.3811	0.6723	-0.2007	-39.3116	29.2522	-253.0955	-33.6843	28.1074	-257.6667
2.912	-36.3338	28.8529	-256.0888	0.6437	-0.1457	-39.8638	29.371	-253.4117	-32.8039	28.3349	-258.7659

Ma12											
time	pos(x)	pos(y)	pos(z)	el	az	x1	y1	z1	x2	y2	z2
2.928	-35.5601	27.7659	-257.223	0.5688	-0.1736	-39.5374	28.4635	-254.6413	-31.5828	27.0682	-259.8047
2.944	-35.565	27.756	-257.9054	0.4738	-0.2789	-39.1177	28.7734	-256.0103	-32.0124	26.7387	-259.8005
2.96	-35.009	26.7152	-259.3473	0.4845	-0.3412	-38.7665	28.0494	-257.2484	-31.2514	25.381	-261.4462
2.976	-34.1515	27.407	-259.5691	0.1495	-0.2009	-38.4697	28.2862	-258.9051	-29.8333	26.5278	-260.233
2.992	-34.9791	27.7322	-260.786	0.2041	-0.2276	-39.5351	28.7876	-259.8182	-30.423	26.6768	-261.7538
3.008	-33.7619	28.0114	-261.4712	0.2932	0.0398	-37.8662	27.848	-260.2313	-29.6575	28.1748	-262.7111
3.024	-33.9249	27.7418	-262.242	0.2359	0.0032	-37.7845	27.7295	-261.3141	-30.0652	27.7542	-263.17
3.04	-33.0596	27.9649	-263.1984	0.0141	-0.0066	-37.6475	27.9954	-263.1336	-28.4716	27.9345	-263.2632
3.056	-33.7479	28.1211	-264.4959	0.1201	0.0699	-37.8128	27.8364	-264.0042	-29.683	28.4057	-264.9876
3.072	-33.4114	27.3224	-265.3911	0.1268	-0.0055	-37.9773	27.3476	-264.8091	-28.8455	27.2972	-265.973
3.088	-33.2446	27.8707	-266.9919	0.2122	-0.0747	-38.2331	28.2442	-265.9144	-28.256	27.4971	-268.0695
3.104	-32.8804	27.502	-267.2517	0.1748	-0.0575	-36.9539	27.7363	-266.5313	-28.8069	27.2677	-267.9722
3.12	-32.3363	27.6186	-269.5528	0.312	0.0495	-36.4398	27.4155	-268.2277	-28.2328	27.8218	-270.878
3.136	-32.2293	26.7797	-271.7657	0.2712	-0.221	-37.246	27.907	-270.336	-27.2127	25.6525	-273.1954
3.152	-31.75	25.6389	-273.3007	0.5599	-0.1301	-35.2619	26.0985	-271.0807	-28.2382	25.1792	-275.5207
3.168	-31.6385	25.5626	-274.1653	0.6882	-0.24	-35.0963	26.4088	-271.2381	-28.1808	24.7164	-277.0925
3.184	-31.8795	25.4144	-276.2223	0.8713	-0.1757	-34.5896	25.8956	-272.9512	-29.1693	24.9331	-279.4934
3.2	-31.8351	25.5083	-277.7592	0.7566	-0.1628	-34.7959	25.9945	-274.9267	-28.8743	25.022	-280.5918
3.216	-32.8431	25.0976	-279.2171	1.0456	-0.1294	-34.8269	25.3556	-275.7648	-30.8594	24.8395	-282.6694
3.232	-32.8135	25.4372	-280.6231	0.8271	-0.2118	-35.5784	26.0317	-277.549	-30.0486	24.8428	-283.6972
3.248	-32.2797	25.4685	-282.4795	0.7932	-0.2148	-35.2936	26.126	-279.3465	-29.2658	24.8109	-285.6126
3.264	-33.0117	25.599	-283.5584	0.8764	-0.2561	-35.6318	26.2852	-280.3061	-30.3917	24.9128	-286.8106
3.28	-33.4582	25.213	-285.2008	0.9529	-0.2798	-36.0184	25.9487	-281.4529	-30.8979	24.4774	-288.9488
3.296	-34.0873	25.1536	-286.917	1.2389	-0.1212	-35.417	25.3156	-283.0305	-32.7576	24.9916	-290.8035
3.312	-36.1557	24.6652	-288.344	1.3351	-1.7781	-35.9984	25.4126	-285.1637	-36.3129	23.9177	-291.5243
3.328	-36.4285	24.8351	-289.5624	1.3489	-1.0172	-36.8071	25.4477	-286.3709	-36.0499	24.2226	-292.7539
3.344	-37.3686	24.6738	-290.7899	1.3192	-2.5306	-36.7141	25.1321	-287.6818	-38.023	24.2154	-288.898
3.36	-37.7833	24.4629	-291.9512	1.2074	-2.7933	-36.6457	24.876	-288.7685	-38.9209	24.0499	-295.134
3.376	-37.581	23.8788	-292.7817	1.1823	-2.7438	-36.4262	24.3641	-289.7211	-38.7358	23.3935	-295.8423
3.392	-38.2293	23.6597	-293.7316	1.0606	-2.9865	-36.5345	23.9246	-290.6666	-39.9241	23.3948	-296.7967
3.408	-38.5055	23.7869	-295.0945	1.0053	3.0729	-36.6482	23.659	-292.1611	-40.3629	23.9147	-298.0279
3.424	-38.5463	23.1667	-295.7196	0.8872	-2.6837	-36.9704	23.9434	-293.5628	-40.1223	22.3901	-297.8763
3.44	-39.3871	23.1061	-296.2944	0.8879	-2.5869	-38.0178	23.9545	-294.3142	-40.7563	22.2577	-298.2745
3.456	-38.9784	22.7082	-297.8651	0.5836	-2.9612	-36.6289	23.1368	-296.2881	-41.3278	22.2796	-299.4422
3.472	-39.5471	23.2824	-298.5497	0.5068	-3.0133	-37.2748	23.5756	-297.2777	-41.8193	22.9892	-299.8217
3.488	-39.257	22.8893	-299.0737	0.4914	-3.0017	-37.1769	23.1823	-297.9496	-41.337	22.5963	-300.1978
3.504	-39.1254	22.6351	-299.9511	0.4811	-2.9318	-37.3312	23.0172	-298.9934	-40.9196	22.2531	-300.9087
3.52	-39.8618	22.4521	-300.7916	0.3087	3.1306	-36.0702	22.4103	-299.5825	-43.6534	22.4939	-302.0008
3.536	-40.7255	22.6912	-302.2662	0.1611	2.9944	-35.849	21.968	-301.4652	-45.602	23.4144	-303.0672
3.552	-39.8414	21.7459	-302.8578	0.105	3.1028	-35.4252	21.5743	-302.392	-44.2576	21.9175	-303.3236
3.568	-40.6198	21.3677	-304.0375	0.0564	3.0997	-36.3577	21.1892	-303.7967	-44.8819	21.5462	-304.2783
3.584	-42.7182	21.9734	-305.1913	-0.0424	2.9605	-37.8885	21.0892	-305.3998	-47.5479	22.8576	-304.9827
3.6	-42.3224	20.652	-306.6084	-0.1517	3.0001	-37.3737	19.947	-307.3725	-47.2712	21.3571	-305.8443
3.616	-41.881	20.5845	-307.6931	-0.1977	2.9728	-37.2365	19.7931	-308.6368	-46.5254	21.3758	-306.7495
3.632	-43.1105	21.2066	-308.1134	-0.1495	2.8456	-38.3257	19.7475	-308.8669	-47.8952	22.6656	-307.3599
3.648	-43.1018	20.3244	-309.3205	-0.3799	2.8807	-39.2916	19.3071	-310.8952	-46.912	21.3417	-307.7458
3.664	-42.6277	20.9353	-310.6133	-0.3869	2.7618	-38.6268	19.3383	-312.3687	-46.6287	22.5323	-308.858

Manta											
time	pos(x)	pos(y)	pos(z)	el	az	x1	y1	z1	x2	y2	z2
0	0	0	0	-0.0153	0.0443	-3.9524	-0.1753	-0.0604	3.9524	0.1753	0.0604
0.016	-0.4473	0.5339	-6.0283	0.209	0.2822	-3.3232	-0.2998	-5.3932	2.4285	1.3677	-6.6633
0.032	-1.7777	1.0768	-10.0586	0.4986	0.3643	-4.0577	0.2075	-8.7301	0.5023	1.9462	-11.3872
0.048	-3.125	1.81	-12.6615	0.8231	1.6358	-3.0326	0.3919	-11.1289	-3.2174	3.2282	-14.1942
0.064	-2.9049	2.205	-15.1152	1.0949	2.2679	-2.1924	1.3541	-12.9618	-3.6174	3.0559	-17.2685
0.08	-3.188	2.4202	-17.9926	0.4916	2.7383	-0.6934	1.3557	-16.5403	-5.6825	3.4848	-19.445
0.096	-3.5202	1.9738	-21.3703	0.4418	2.806	-0.4413	0.9	-19.828	-6.599	3.0475	-22.9126
0.112	-3.8646	2.8272	-22.6128	0.4778	2.8893	-1.1615	2.1303	-21.1674	-6.5677	3.5241	-24.0583
0.128	-4.1169	2.8201	-25.1851	0.3168	3.0224	-0.424	2.3777	-23.9657	-7.8097	3.2624	-26.4046
0.144	-4.7024	3.2185	-26.0761	0.327	2.9166	-1.52	2.4901	-24.9687	-7.8848	3.947	-27.1835
0.16	-4.2801	2.9351	-28.2651	0.5527	2.8682	-1.9515	2.2822	-26.7734	-6.6088	3.5881	-29.7568
0.176	-4.4815	2.5497	-30.1528	0.4436	2.8103	-1.9098	1.665	-28.8603	-7.0532	3.4343	-31.4452
0.192	-4.6245	3.7034	-30.0462	0.393	2.9437	-1.5686	3.0906	-28.7539	-7.6804	4.3162	-31.3384
0.208	-4.477	4.5947	-31.7687	0.5761	2.7092	-2.298	3.589	-30.2098	-6.6559	5.6004	-33.3276
0.224	-4.4887	5.2973	-32.3622	0.8053	2.5288	-3.1084	4.3268	-30.6063	-5.869	6.2678	-34.1182

Ma13

time	pos(x)	pos(y)	pos(z)	el	az	x1	y1	z1	x2	y2	z2
0.24	-3.7391	5.5845	-33.6058	0.9301	2.157	-2.9301	4.3663	-31.6448	-4.5481	6.8026	-35.5668
0.256	-3.2897	5.7334	-34.6199	1.0042	2.1165	-2.6688	4.7109	-32.7394	-3.9105	6.7559	-36.5004
0.272	-2.7397	5.7696	-36.0097	1.1794	1.2785	-3.0206	4.836	-33.6472	-2.4587	6.7033	-38.3723
0.288	-2.1483	6.07	-36.9337	0.9828	1.4774	-2.2604	4.8734	-35.1311	-2.0363	7.2666	-38.7364
0.304	-1.3631	5.9233	-37.3438	0.7954	0.7883	-2.5145	4.765	-35.6774	-0.2116	7.0816	-39.0101
0.32	-0.8419	6.2326	-37.7168	0.6415	0.3591	-3.0463	5.4052	-35.9584	1.3626	7.06	-39.4753
0.336	-0.0366	6.4286	-38.0615	0.5804	0.4083	-2.2583	5.4675	-36.4742	2.185	7.3897	-39.6489
0.352	0.9279	6.6148	-38.5232	0.4277	0.1542	-1.9835	6.1622	-37.18	3.8394	7.0674	-39.8664
0.368	0.7612	6.002	-39.9452	0.3828	0.1359	-1.8677	5.6424	-38.8769	3.3902	6.3615	-41.0135
0.384	1.2744	6.291	-40.5827	0.3793	0.0945	-1.9678	5.9836	-39.2844	4.5167	6.5984	-41.881
0.4	1.4177	6.2186	-41.7716	0.5372	0.1426	-1.6207	5.7824	-39.9432	4.4562	6.6548	-43.6
0.416	1.6213	6.1054	-41.8531	0.2856	0.0852	-2.0509	5.7917	-40.7711	5.2934	6.419	-42.9351
0.432	2.0438	5.9494	-42.3954	0.3684	-0.0021	-1.617	5.9573	-40.9823	5.7046	5.9416	-43.8084
0.448	2.0172	6.263	-43.33	0.3938	0.0465	-0.991	6.123	-42.0789	5.0255	6.403	-44.5812
0.464	1.6876	6.0279	-44.4128	0.2908	0.0742	-1.7939	5.7693	-43.368	5.169	6.2866	-45.4575
0.48	1.7759	6.1492	-45.1384	0.1298	0.3321	-1.4257	5.0449	-44.6962	4.9775	7.2535	-45.5805
0.496	1.8979	5.833	-46.2134	0.2734	0.1588	-1.3762	5.3086	-45.2837	5.172	6.3573	-47.1431
0.512	2.0835	6.1464	-47.2586	0.4321	0.1448	-1.048	5.6899	-45.7991	5.2149	6.603	-48.7182
0.528	2.3587	6.081	-48.3271	0.4179	-0.075	-1.5798	6.377	-46.5732	6.2972	5.785	-50.0811
0.544	1.5561	6.845	-49.3578	0.5205	0.3446	-1.2805	5.827	-47.6302	4.3928	7.8629	-51.0855
0.56	1.9817	6.8049	-50.3628	0.6166	0.3443	-0.191	6.0258	-48.7267	4.1545	7.584	-51.9988
0.576	1.2697	7.7384	-50.2518	0.8087	0.2493	-0.7893	7.2142	-48.0258	3.3287	8.2626	-52.4778
0.592	1.4072	6.5031	-52.2552	0.8519	0.1957	-0.6634	6.0926	-49.8429	3.4778	6.9135	-54.6675
0.608	1.4703	7.1927	-52.5937	0.8159	0.2284	-0.7714	6.6715	-50.1472	3.7119	7.7138	-55.0401
0.624	0.2082	7.6676	-53.9042	0.8719	0.0951	-2.4201	7.417	-50.7623	2.8364	7.9182	-57.046
0.64	0.0686	7.5924	-55.3538	0.9828	0.1907	-1.5318	7.2835	-52.909	1.6689	7.9013	-57.7985
0.656	-0.0492	7.2418	-57.1336	1.1116	0.4332	-1.1082	6.752	-54.7737	1.0097	7.7315	-59.4935
0.672	-0.8971	7.8868	-57.5725	1.3289	1.861	-0.6856	7.1786	-54.577	-1.1086	8.595	-60.568
0.688	-1.3758	7.6272	-58.8509	1.3635	1.4315	-1.4614	7.0163	-55.9177	-1.2901	8.238	-61.7842
0.704	-1.3481	8.2519	-59.7914	1.3638	1.8567	-1.168	7.6391	-56.7493	-1.5282	8.8646	-62.8335
0.72	-1.7291	8.0974	-60.8968	1.3217	2.366	-1.1783	7.5571	-57.8633	-2.28	8.6376	-63.9302
0.736	-2.1936	7.6549	-62.2265	1.3444	2.4473	-1.6412	7.195	-59.1056	-2.7459	8.1148	-65.3473
0.752	-2.9387	8.2934	-62.8328	1.1375	2.3645	-2.137	7.5049	-60.402	-3.7404	9.0818	-65.2636
0.768	-3.9143	8.6181	-64.5644	0.9963	2.6733	-2.2488	7.7756	-61.6808	-5.5799	9.4607	-67.4481
0.784	-4.1836	8.4141	-64.9699	1.1362	2.8081	-2.9903	8.0007	-62.2493	-5.3769	8.8275	-67.6904
0.8	-4.7323	8.5221	-66.218	1.0042	2.8231	-3.0763	7.9762	-63.477	-6.3884	9.068	-68.9591
0.816	-5.5028	8.6272	-67.5036	0.8776	2.9282	-3.3621	8.1632	-64.8671	-7.6435	9.0912	-70.1401
0.832	-5.7979	8.6117	-67.6846	0.6417	2.8174	-3.143	7.7195	-65.5919	-8.4529	9.5039	-69.7772
0.848	-5.7946	8.3712	-69.1519	0.691	2.938	-3.1236	7.8199	-66.8965	-8.4655	8.9225	-71.4072
0.864	-6.3157	8.2169	-69.6874	0.649	2.9747	-3.6174	7.7622	-67.6116	-9.014	8.6715	-71.7632
0.88	-7.0094	8.7126	-70.6378	0.5414	2.8653	-4.0816	7.8825	-68.8077	-9.9372	9.5427	-72.468
0.896	-8.0403	9.0488	-71.3798	0.4191	2.782	-5.0401	7.9209	-69.9518	-11.0404	10.1768	-72.8078
0.912	-8.1577	9.7621	-72.1731	0.3197	2.9231	-4.5216	8.9549	-70.94	-11.7938	10.5694	-73.4062
0.928	-8.4554	9.3734	-73.0147	0.3647	2.9743	-5.1959	8.8231	-71.7527	-11.7148	9.9237	-74.2768
0.944	-9.7095	9.4995	-73.9252	0.353	3.023	-5.9166	9.0475	-72.5178	-13.5024	9.9515	-75.3326
0.96	-9.964	9.3393	-74.9254	0.3867	3.0498	-6.7459	9.0429	-73.6095	-13.1821	9.6357	-76.2412
0.976	-10.6566	10.6614	-75.7645	0.2945	2.9285	-7.203	9.914	-74.6929	-14.1101	11.4088	-76.8361
0.992	-11.0682	10.2463	-77.1616	0.4463	2.9991	-8.2827	9.8467	-75.815	-13.8538	10.6458	-78.5082
1.008	-10.8755	11.0906	-78.076	0.3069	2.8714	-7.7526	10.2256	-77.0491	-13.9985	11.9555	-79.1029
1.024	-11.3508	11.2419	-79.0826	0.3463	2.8783	-8.4562	10.4616	-78.0008	-14.2454	12.0222	-80.1644
1.04	-11.3733	11.5371	-80.2982	0.356	2.9438	-8.302	10.9216	-79.1336	-14.4445	12.1526	-81.4628
1.056	-12.6046	12.3053	-81.2934	0.3054	2.942	-9.1892	11.6143	-80.195	-16.02	12.9963	-82.3918
1.072	-12.8546	12.0408	-82.2208	0.2571	2.994	-9.3927	11.526	-81.3006	-16.3164	12.5557	-83.1411
1.088	-10.2859	11.8492	-83.5517	0.3815	2.8698	-7.9251	11.1912	-82.5686	-12.6467	12.5071	-84.5348
1.104	-10.0757	12.1641	-85.2835	0.4541	2.916	-7.7946	11.6406	-84.141	-12.3568	12.6875	-86.4261
1.12	-10.8043	12.6002	-85.7556	0.3113	2.7911	-8.5487	11.7755	-84.9828	-13.0599	13.425	-86.5284
1.136	-11.4967	13.2497	-87.1746	0.3419	2.6505	-9.1452	11.9921	-86.2256	-13.8482	14.5072	-88.1236
1.152	-11.2897	13.5417	-88.4384	0.52	2.8281	-9.2619	12.8843	-87.2178	-13.3175	14.1991	-89.659
1.168	-11.5741	13.8093	-89.5015	0.4914	2.7432	-9.7636	13.0473	-88.4503	-13.3846	14.5713	-90.5528
1.184	-12.1808	14.636	-91.483	0.4425	2.6762	-9.937	13.5093	-90.2932	-14.4246	15.7627	-92.6728
1.2	-12.0002	14.5733	-92.8382	0.6625	2.6299	-10.3752	13.6607	-91.3841	-13.6253	15.4859	-94.2924
1.216	-12.6005	15.4264	-94.0136	0.7081	2.4605	-11.2086	14.2983	-92.4795	-13.9924	16.5545	-95.5477
1.232	-12.3811	15.5184	-95.7284	0.7484	2.4118	-11.0369	14.3158	-94.0534	-13.7253	16.7209	-97.4034
1.248	-12.6367	16.1518	-97.1993	0.6995	2.369	-11.0813	14.6358	-95.3718	-14.192	17.6677	-99.0268
1.264	-12.1529	16.1554	-98.7677	1.011	1.8266	-11.8053	14.8265	-96.5757	-12.5005	17.4843	-100.9598
1.28	-12.1027	16.6793	-100.1979	1.0429	2.0524	-11.4483	15.4273	-97.7749	-12.757	17.9313	-102.6208

Ma13

time	pos(x)	pos(y)	pos(z)	el	az	x1	y1	z1	x2	y2	z2
1.296	-11.5418	17.292	-101.6766	1.0687	1.2188	-12.01	16.017	-99.2024	-11.0735	18.567	-104.1508
1.312	-11.8758	17.4084	-102.8743	1.1295	0.8813	-12.6167	16.5098	-100.4087	-11.1349	18.3071	-105.3398
1.328	-11.6738	17.3944	-103.4036	1.0887	0.8209	-12.6149	16.3841	-100.7649	-10.7327	18.4047	-106.0424
1.344	-11.2678	17.9909	-104.1069	1.0152	0.5767	-12.7233	17.0443	-101.3101	-9.8123	18.9376	-106.9037
1.36	-11.0065	17.8668	-104.8186	0.9843	0.5661	-12.4809	16.9299	-102.1896	-9.5321	18.8037	-107.4476
1.376	-8.3899	17.3158	-106.1309	0.7685	-0.0323	-11.2901	17.4096	-103.3256	-5.4897	17.222	-108.9363
1.392	-9.6543	18.0215	-106.4145	0.7586	0.0536	-12.2848	17.8802	-103.9177	-7.0238	18.1627	-108.9113
1.408	-9.1774	17.7441	-107.5331	0.7698	0.0427	-11.8601	17.6295	-104.9307	-6.4947	17.8586	-110.1355
1.424	-9.0625	17.4307	-108.9882	0.6784	-0.0412	-12.3919	17.5678	-106.3022	-5.733	17.2937	-111.6742
1.44	-9.4133	17.6023	-109.8899	0.5942	-0.1194	-12.2735	17.9455	-107.9435	-6.5532	17.2592	-111.8363
1.456	-8.1303	17.6987	-111.0025	0.4913	-0.1008	-11.4594	18.0353	-109.2123	-4.8012	17.3622	-112.7926
1.472	-9.3942	17.8268	-111.9508	0.35	-0.1198	-12.5087	18.2019	-110.8056	-6.2796	17.4518	-113.096
1.488	-8.0519	17.6051	-112.882	0.1951	-0.1674	-11.5899	18.2031	-112.1729	-4.5139	17.0071	-113.5912
1.504	-8.2291	17.6331	-114.3604	0.1781	-0.1856	-12.1856	18.3761	-113.6358	-4.2725	16.8902	-113.0849
1.52	-8.145	17.8767	-115.1532	0.135	-0.2155	-11.992	18.7189	-114.6183	-4.298	17.0346	-115.6882
1.536	-6.6562	18.2166	-116.4229	0.1511	-0.2087	-10.0009	18.9249	-115.9021	-3.3114	17.5083	-116.9436
1.552	-7.1035	18.3395	-116.9627	-0.0064	-0.2501	-10.5633	19.2232	-116.9854	-3.6436	17.4558	-116.94
1.568	-6.2978	18.0641	-118.1996	0.0582	-0.2167	-10.345	18.9553	-117.9582	-2.2506	17.173	-118.4409
1.584	-5.6417	18.0055	-119.0499	0.0145	-0.2133	-8.7988	18.6895	-119.0031	-2.4845	17.3216	-119.0968
1.6	-5.3169	18.0563	-120.885	-0.0698	-0.0925	-8.8504	18.384	-121.1331	-1.7835	17.7287	-120.637
1.616	-4.5978	17.8097	-122.365	-0.214	-0.1995	-7.9111	18.4794	-123.0995	-1.2844	17.1399	-121.6304
1.632	-4.1765	18.5549	-123.9577	-0.1577	-0.171	-7.4896	19.127	-124.4925	-0.8634	17.9828	-123.423
1.648	-3.8877	18.4671	-125.3829	-0.2238	-0.2557	-7.7747	19.4833	-126.2974	-0.0006	17.451	-124.4684
1.664	-3.3145	18.6809	-127.1547	-0.1793	-0.2142	-7.2833	19.5442	-127.8908	0.6543	17.8176	-126.4185
1.68	-3.2129	18.5406	-128.2976	-0.1022	-0.2333	-6.5328	19.3295	-128.6475	0.107	17.7517	-127.9476
1.696	-2.1554	18.9325	-130.1575	-0.0924	-0.146	-5.6198	19.442	-130.4822	1.3089	18.4231	-129.8329
1.712	-1.6794	18.8276	-132.4396	-0.0874	-0.1942	-4.8649	19.4542	-132.724	1.5061	18.2011	-132.1552
1.728	-1.4386	19.4371	-134.3788	-0.1349	-0.1932	-5.6668	20.2642	-134.9637	2.7897	18.61	-133.794
1.744	-0.2926	19.0725	-135.9189	-0.1093	-0.2407	-3.6177	19.8887	-136.2946	3.0325	18.2563	-135.5432
1.76	-0.0631	19.481	-138.3174	-0.0846	-0.1835	-3.8798	20.1896	-138.6464	3.7537	18.7725	-137.9883
1.776	-0.2461	19.9532	-140.732	-0.1307	-0.238	-4.5228	20.9909	-141.3106	4.0306	18.9155	-140.1534
1.792	0.1358	20.078	-142.8148	-0.0257	-0.1777	-3.7153	20.7698	-142.9152	3.9869	19.3862	-142.7144
1.808	0.7189	20.3093	-144.0321	0.3442	-0.1844	-3.0388	21.0102	-142.6617	4.4767	19.6083	-145.4026
1.824	0.0662	20.2579	-145.571	0.5972	-0.2158	-2.7574	20.8768	-143.6054	2.8899	19.639	-147.5367
1.84	-0.1303	20.8388	-147.8242	0.6981	-0.0781	-2.8441	21.0511	-145.5403	2.5835	20.6264	-150.1081
1.856	0.9981	21.4308	-150.3097	1.0174	-0.1101	-0.549	21.6018	-147.79	2.5452	21.2599	-152.8294
1.872	-0.2994	21.9004	-151.8095	1.1794	0.2144	-1.5948	21.6184	-148.5975	0.996	22.1825	-155.0215
1.888	-0.7219	22.2817	-153.4156	1.5319	0.5693	-0.824	22.2163	-150.3017	-0.6197	22.3471	-156.5295
1.904	-2.3558	22.9233	-155.6645	1.4187	1.9741	-2.1666	22.4799	-152.52	-2.545	23.3667	-158.8089
1.92	-2.8028	22.6528	-157.2377	1.2801	2.5589	-1.9693	22.1035	-153.9018	-3.6363	23.202	-160.5737
1.936	-3.4602	23.1254	-158.0164	1.2579	1.9643	-3.0076	22.0353	-154.3683	-3.9128	24.2155	-161.6645
1.952	-4.1415	23.2922	-158.4571	0.8816	2.8244	-1.9767	22.5815	-155.6917	-6.3063	24.0029	-161.2225
1.968	-4.6823	23.7627	-159.5589	0.8487	2.6529	-2.521	22.6135	-156.7796	-6.8435	24.9119	-162.3381
1.984	-5.5646	24.1335	-159.5919	0.6253	2.7463	-3.0841	23.0985	-157.6517	-8.0451	25.1685	-161.5322
2	-5.4114	24.4799	-160.4178	0.5954	2.7336	-3.3593	23.5929	-158.9033	-7.4636	25.367	-161.9323
2.016	-5.6885	24.2328	-160.8896	0.37	2.7568	-3.3647	23.2918	-159.9171	-8.0123	25.1739	-161.862
2.032	-5.8099	24.4115	-161.2765	0.3815	2.9244	-3.9098	23.9923	-160.4958	-7.7099	24.8308	-162.0571
2.048	-5.5051	24.2052	-162.5536	0.4395	2.757	-3.4003	23.5371	-161.7162	-6.7018	24.8733	-163.391
2.064	-6.2757	24.5006	-163.2648	0.1771	2.9035	-4.2245	24.0028	-162.887	-8.3268	24.9984	-163.6426
2.08	-6.315	24.8852	-164.947	0.1882	2.9275	-3.9952	24.3809	-164.4948	-8.6348	25.3896	-165.3991
2.096	-8.4495	25.6232	-166.2524	0.0755	2.9619	-5.1527	25.0244	-165.9989	-11.7462	26.2221	-166.5058
2.112	-7.527	25.6861	-167.5092	0.2196	2.8842	-4.3311	24.845	-166.7714	-10.7229	26.5273	-168.2469
2.128	-8.2284	25.9228	-168.4989	0.0598	2.9331	-4.9188	25.2224	-168.2963	-11.5381	26.6231	-168.7016
2.144	-9.0509	26.2527	-169.8854	0.09	2.9265	-6.0009	25.5865	-169.6036	-12.1009	26.9189	-170.1673
2.16	-8.9557	25.951	-171.7649	0.1629	2.8552	-5.471	24.9246	-171.1677	-12.4405	26.9773	-172.362
2.176	-8.8432	26.0833	-173.3868	0.1901	2.8701	-5.5089	25.155	-172.7208	-12.1776	27.0115	-174.0527
2.192	-9.2956	26.512	-175.0556	0.2272	2.8894	-5.7883	25.6082	-174.2183	-12.8028	27.4158	-175.8929
2.208	-9.0144	26.2025	-176.6779	0.3033	2.8806	-6.3503	25.4909	-175.8149	-11.6785	26.914	-177.5409
2.224	-9.4525	26.4088	-177.9011	0.3301	2.8968	-6.6525	25.7094	-176.9122	-12.2524	27.1082	-178.8899
2.24	-9.3241	26.4549	-179.7579	0.3507	2.8756	-6.6491	25.7262	-178.7437	-11.9991	27.1837	-180.772
2.256	-9.2114	26.5697	-181.3704	0.3044	2.897	-6.4073	25.8699	-180.4626	-12.0154	27.2695	-182.2782
2.272	-9.6595	26.9495	-183.875	0.4062	2.8232	-6.6833	25.9684	-182.5272	-12.6357	27.9305	-185.2227
2.288	-9.2517	26.8902	-185.3144	0.5224	2.8443	-6.7068	26.1104	-183.782	-11.7966	27.6699	-186.8467
2.304	-9.6915	27.3374	-187.613	0.6709	2.8794	-7.2837	26.6914	-185.6342	-12.0992	27.9835	-189.5918
2.32	-9.1485	27.455	-189.6065	0.6968	2.7628	-6.7374	26.4953	-187.4348	-11.5596	28.4147	-191.7782
2.336	-9.2928	27.7067	-191.5252	0.9301	2.6982	-7.579	26.8927	-188.9806	-11.0066	28.5207	-194.0698

Ma13

time	pos(x)	pos(y)	pos(z)	el	az	x1	y1	z1	x2	y2	z2
2.352	-8.461	28.0132	-193.665	1.1477	2.5456	-7.3118	27.2339	-190.5819	-9.6101	28.7926	-196.7482
2.368	-6.7666	27.5829	-195.2403	1.3159	2.3751	-6.1963	27.0338	-192.2022	-7.3368	28.132	-198.2784
2.384	-5.2177	27.1812	-197.5476	1.4389	1.2559	-5.3631	26.7348	-194.0079	-5.0723	27.6276	-201.0873
2.4	-5.636	27.2836	-198.4682	1.5409	1.4823	-5.6461	27.1701	-194.663	-5.626	27.3972	-202.2734
2.416	-5.2114	27.1984	-199.7466	1.1752	-0.0173	-6.4827	27.2203	-196.702	-3.9402	27.1764	-202.7913
2.432	-3.4092	26.3393	-200.4667	1.2974	-0.3812	-4.2485	26.6757	-197.2421	-2.5699	26.0029	-203.6914
2.448	-3.8282	26.6948	-201.439	0.8093	-0.2459	-6.48	27.3604	-198.5711	-1.1765	26.0292	-204.3069
2.464	-1.8922	26.3595	-202.1448	0.7969	-0.3251	-4.8015	27.3401	-199.0034	1.0171	25.3788	-205.2862
2.48	-2.7104	26.8012	-202.893	0.6957	-0.3071	-5.3544	27.6396	-200.5772	-0.0664	25.9628	-205.2087
2.496	-2.3137	26.7956	-203.6741	0.4355	-0.3767	-6.1926	28.3301	-201.7334	1.5652	25.2612	-205.6148
2.512	-1.7572	26.2484	-204.3974	0.6043	-0.3314	-5.3544	27.4863	-201.7708	1.84	25.0104	-207.0239
2.528	-1.6049	26.4654	-206.009	0.1178	-0.2421	-5.8813	27.5212	-205.4877	2.6716	25.4095	-206.5303
2.544	0.4514	25.5775	-206.3242	0.3403	-0.2381	-3.1153	26.4432	-205.0247	4.0182	24.7117	-207.6237
2.56	0.1966	25.7647	-207.5124	0.3028	-0.2421	-3.3788	26.6476	-206.3617	3.772	24.8818	-208.663
2.576	1.5861	25.5001	-208.6601	0.248	-0.2054	-2.2423	26.2977	-207.6698	5.4145	24.7024	-209.6504
2.592	1.5721	25.3462	-210.0375	0.0151	-0.2529	-2.5196	26.4037	-209.9736	5.6639	24.2888	-210.1015
2.608	1.7066	25.5575	-210.8418	0.0504	-0.2581	-2.5338	26.6767	-210.6205	5.9469	24.4382	-211.063
2.624	2.3956	25.209	-211.9382	0.0468	-0.209	-1.968	26.1345	-211.7292	6.7592	24.2835	-212.1472
2.64	2.8275	25.0453	-214.0131	-0.0096	-0.2135	-1.3956	25.9611	-214.0547	7.0507	24.1296	-213.9715
2.656	2.7063	25.0527	-215.512	0.0193	-0.2594	-0.8284	25.9906	-215.4414	6.2409	24.1149	-215.5827
2.672	3.2943	25.0517	-216.905	-0.0846	-0.2202	-0.5043	25.9019	-217.235	7.0929	24.2015	-216.5751
2.688	4.1517	24.737	-219.0326	0.0257	-0.14	0.604	25.237	-218.9404	7.6994	24.237	-219.1248
2.704	3.8604	24.9504	-220.143	0.0044	-0.1698	0.3265	25.5564	-220.1273	7.3943	24.3444	-220.1587
2.72	4.5834	24.8926	-222.202	-0.1183	-0.1824	0.3897	25.6663	-222.7088	8.7771	24.1189	-221.6951
2.736	5.4042	24.1631	-224.7777	-0.1029	-0.2293	0.9358	25.2063	-225.2514	9.8727	23.12	-224.3041
2.752	4.8993	24.1547	-226.2736	-0.1131	-0.2227	1.2422	24.9827	-226.6997	8.5564	23.3267	-225.8476
2.768	5.6314	24.4254	-228.6686	-0.1481	-0.2081	1.3014	25.3398	-229.3286	9.9614	23.511	-228.0085
2.784	6.1919	24.0381	-230.9306	-0.1349	-0.2256	2.6761	24.8452	-231.4203	9.7077	23.2311	-230.4408
2.8	6.171	23.8905	-232.7592	-0.1272	-0.2182	1.5805	24.9083	-233.3608	10.7615	22.8726	-232.1577
2.816	5.8564	23.9594	-235.2835	-0.0594	-0.2549	1.9128	24.9869	-235.526	9.8001	22.9319	-235.0411
2.832	5.9585	23.9563	-237.5288	0.3989	-0.2471	2.0264	24.9482	-235.8194	9.8907	22.9645	-239.2382
2.848	6.2219	23.1614	-240.2029	0.5595	-0.4119	2.8402	24.6387	-237.8917	9.6035	21.6841	-242.5141
2.864	6.143	22.7963	-241.967	0.7458	-0.436	3.6695	23.9486	-239.4462	8.6165	21.6439	-244.4878
2.88	7.0131	22.7817	-243.5617	0.8161	-0.2536	4.2643	23.4941	-240.5423	9.7618	22.0693	-246.5812
2.896	6.3249	23.1389	-246.3288	1.0965	-0.5572	4.9439	23.9994	-243.1597	7.7059	22.2785	-249.4979
2.912	4.8863	23.0851	-248.2427	1.2814	-0.717	4.1252	23.7486	-244.8512	5.6475	22.4216	-251.6343
2.928	5.6672	23.2002	-250.5792	1.3493	-0.9547	5.208	23.8486	-247.0501	6.1264	22.5517	-254.1083
2.944	3.3155	23.2212	-251.5891	1.4968	-2.5885	3.5279	23.3523	-248.2207	3.1031	23.09	-254.9575
2.96	2.962	23.0847	-252.0736	1.26	-2.9782	4.1011	23.2726	-248.4799	1.8229	22.8969	-255.6673
2.976	2.3952	23.2567	-253.1461	1.1968	-3.1389	3.584	23.2599	-250.117	1.2065	23.2535	-256.1752
2.992	2.0411	22.9849	-253.6219	0.8619	3.0025	4.1595	22.6883	-251.1276	-0.0773	23.2814	-256.1162
3.008	2.0264	22.7334	-253.6838	0.7493	2.8902	3.893	22.254	-251.8907	0.1597	23.2128	-255.4769
3.024	1.5407	22.6973	-255.0397	0.5547	2.9289	4.4812	22.0622	-253.1757	-1.3997	23.3323	-256.9037
3.04	1.3491	22.6502	-256.1676	0.5362	3.0076	4.2691	22.2567	-254.4168	-1.5708	23.0437	-257.9184
3.056	1.0651	22.5193	-256.8867	0.2767	2.927	4.5703	21.7553	-255.8679	-2.4401	23.2832	-257.9056
3.072	1.3651	22.0366	-258.1344	0.4646	2.987	4.303	21.5787	-256.6441	-1.5728	22.4945	-259.6247
3.088	0.0384	22.2946	-259.4609	0.3041	2.9082	4.0847	21.3327	-258.1558	-4.0079	23.2564	-260.766
3.104	0.0346	22.5157	-260.0048	0.2236	2.8882	4.1419	21.4523	-259.0401	-4.0726	23.5791	-260.9695
3.12	-1.5321	22.6448	-260.8648	0.1961	2.9275	2.4232	21.7849	-260.0607	-5.4873	23.5047	-261.6689
3.136	-1.0694	22.0479	-262.1725	0.1675	2.9882	2.6876	21.4669	-261.5298	-4.8264	22.6289	-262.8152
3.152	-1.1776	22.1521	-263.3637	0.2383	3.0268	2.7254	21.702	-262.4094	-5.0805	22.6022	-264.318
3.168	-1.2192	22.0018	-265.0425	0.127	3.0377	2.2941	21.6354	-264.5914	-4.7325	22.3683	-265.4936
3.184	-2.3586	21.6649	-266.3915	0.2213	3.088	1.4374	21.4613	-265.5361	-6.1545	21.8685	-267.2469
3.2	-2.2395	21.5669	-268.1874	0.1096	2.9691	1.8369	20.8568	-267.7321	-6.3159	22.277	-268.6428
3.216	-1.3628	20.9132	-269.7388	0.3014	2.9887	2.1042	20.379	-268.6483	-4.8299	21.4475	-270.8292
3.232	-1.7488	20.9299	-271.3014	0.2493	3.0744	2.6561	20.6334	-270.1772	-6.1538	21.2264	-272.4256
3.248	-2.6884	20.7755	-273.1906	0.3822	-3.1308	0.3372	20.8082	-271.9744	-5.714	20.7427	-274.4068
3.264	-2.7627	21.1204	-274.7243	0.4199	3.0827	0.3902	20.9347	-273.3141	-5.9157	21.3062	-276.1345
3.28	-3.5389	20.5935	-276.1101	0.3077	3.1171	-0.1566	20.5106	-275.0348	-6.9212	20.6765	-277.1855
3.296	-3.4588	20.3516	-277.5605	0.2475	3.052	0.2272	20.0207	-276.6252	-7.1448	20.6826	-278.4958
3.312	-2.3375	19.8727	-279.3194	0.4255	-3.1373	0.4758	19.8848	-278.0446	-5.1508	19.8606	-280.5942
3.328	-2.7349	19.4025	-281.8885	0.5343	-3.0709	-0.2026	19.5818	-280.3863	-5.2672	19.2233	-283.3906
3.344	-2.4494	19.3661	-283.2565	0.4911	-3.0509	0.0921	19.5972	-281.8916	-4.9909	19.135	-284.6214
3.36	-2.8563	18.9476	-285.1337	0.6377	-2.9603	-0.5981	19.3616	-283.4325	-5.1145	18.5337	-286.8349
3.376	-2.7576	18.8163	-287.4647	0.8814	-2.9593	-1.0656	19.1282	-285.3776	-4.4496	18.5045	-289.5518
3.392	-2.0432	18.3751	-289.6305	1.0328	-2.7944	-0.4786	18.9413	-286.8421	-3.6078	17.8088	-292.419

Ma13											
time	pos(x)	pos(y)	pos(z)	el	az	x1	y1	z1	x2	y2	z2
3.408	-1.6939	18.7287	-291.3064	1.1474	-2.952	-0.4791	18.9618	-288.5614	-2.9087	18.4955	-294.0515
3.424	-1.7642	18.5334	-292.8403	1.3582	-2.0156	-1.4942	19.0998	-289.9338	-2.0342	17.9671	-295.7469
3.44	-1.3559	18.5112	-294.7796	1.3723	-1.3462	-1.4958	19.1232	-291.6586	-1.2161	17.8992	-297.9006
3.456	0.083	18.4511	-296.7798	1.0934	-0.5476	-1.3234	19.3087	-293.5954	1.4895	17.5934	-299.9643
3.472	4.3861	17.4705	-297.3378	0.9268	-0.2726	2.3867	18.0294	-294.5728	6.3856	16.9117	-300.1027
3.488	4.7141	17.0055	-297.3536	0.694	-0.3565	1.9093	18.0501	-294.863	7.5189	15.9608	-299.8441
3.504	4.8862	16.8415	-298.7001	0.6281	-0.4105	2.2525	17.9878	-296.6141	7.5199	15.6952	-300.7861
3.52	5.0595	16.5301	-299.8298	0.6055	-0.3082	1.8162	17.5624	-297.4736	8.3028	15.4978	-302.186
3.536	5.0856	16.4551	-300.5051	0.4578	-0.1453	1.8921	16.9223	-298.9147	8.2792	15.9878	-302.0955
3.552	5.0519	16.556	-301.4753	0.5019	-0.2198	1.8163	17.2789	-299.6557	8.2875	15.833	-303.2948
3.568	6.0867	16.7243	-301.9554	0.3427	-0.2502	2.3325	17.6836	-300.5728	9.8408	15.7649	-303.3379
3.584	5.4541	16.7593	-302.869	0.2313	-0.284	1.0322	18.0498	-301.7841	9.876	15.4687	-303.9538
3.6	7.2104	16.495	-303.2214	0.2046	-0.2069	3.4942	17.2752	-302.4336	10.9267	15.7148	-304.0091
3.616	7.1641	16.7635	-304.3054	-0.0309	-0.1759	3.4768	17.4189	-304.4213	10.8515	16.1081	-304.1895
3.632	7.6658	16.265	-305.6962	0.0215	-0.181	3.8804	16.9578	-305.6133	11.4512	15.5722	-305.7792
3.648	8.3534	16.1557	-306.8656	-0.0336	-0.1309	4.1397	16.7103	-307.0083	12.5671	15.601	-306.7229
3.664	8.1203	15.4656	-307.9747	-0.2684	-0.126	4.1881	15.9639	-309.0649	12.0526	14.9674	-306.8844
3.68	8.7869	14.9788	-308.6012	-0.178	-0.1942	5.2016	15.6838	-309.2584	12.3721	14.2738	-307.944
3.696	9.7548	14.7194	-310.9687	-0.3843	-0.0203	6.129	14.793	-312.4353	13.3806	14.6458	-309.5021
3.712	10.264	14.6659	-312.1448	-0.2603	-0.2427	6.8198	15.5187	-313.0898	13.7082	13.8132	-311.1998
3.728	11.1264	14.1351	-313.8751	-0.2486	-0.1745	6.6943	14.9164	-315.0175	15.5585	13.3538	-312.7326

Manta											
time	pos(x)	pos(y)	pos(z)	el	az	x1	y1	z1	x2	y2	z2
0.016	-0.8185	0.8959	-4.4092	0.2547	-0.0195	-4.3194	0.964	-3.4976	2.6823	0.0182	-0.645
0.032	-1.0584	0.9257	-10.0848	0.3927	0.0547	-4.3197	0.7471	-8.7317	2.2029	1.1043	-11.4379
0.048	-2.1312	2.2525	-12.54	0.524	0.2186	-4.5611	1.7128	-11.1016	0.2987	2.7922	-13.9785
0.064	-1.5686	2.7812	-14.8606	0.9054	0.6416	-2.8015	1.8602	-12.8996	-0.3357	3.7022	-16.8217
0.08	-3.885	3.118	-17.8721	1.1243	2.3095	-3.1157	2.2733	-15.4857	-4.6543	3.9628	-20.2586
0.096	-3.6093	3.1606	-21.1836	0.8296	2.6451	-1.9562	2.2649	-19.1295	-5.2625	4.0563	-23.2377
0.112	-4.3277	3.0604	-23.8158	0.6282	2.8712	-1.7489	2.3456	-21.8719	-6.9065	3.7753	-25.7597
0.128	-4.0635	3.4713	-24.9077	0.4828	2.9973	-1.1761	3.0519	-23.3782	-6.951	3.8908	-26.4372
0.144	-5.0927	3.7143	-26.2536	0.1413	2.9898	-1.376	3.1459	-25.7187	-8.8095	4.2827	-26.7886
0.16	-4.9682	3.4097	-27.5879	0.1855	3.0658	-1.1864	3.1224	-26.8761	-8.75	3.697	-28.2998
0.176	-5.4703	3.7921	-29.2306	0.1774	3.1314	-1.7629	3.7543	-28.566	-9.1777	3.83	-29.8951
0.192	-5.313	3.3457	-31.5842	0.1506	3.0482	-1.6135	2.9992	-31.0204	-9.0125	3.6922	-32.148
0.208	-5.3045	5.4046	-31.7233	0.1599	2.8561	-1.6955	4.3455	-31.1168	-8.9135	6.4637	-32.3299
0.224	-5.6932	6.1853	-32.0316	0.1948	2.8312	-2.4988	5.1605	-31.3697	-8.8876	7.2101	-32.6935
0.24	-5.5649	6.2949	-34.1082	0.207	2.8494	-1.8478	5.1767	-33.293	-9.282	7.413	-34.9235
0.256	-5.3053	6.2254	-36.8292	0.3803	2.8261	-2.5046	5.3113	-35.6514	-8.106	7.1394	-38.0069
0.272	-4.7864	6.081	-39.1012	0.5758	2.8355	-2.4505	5.3428	-37.5108	-7.1222	6.8193	-40.6916
0.288	-4.1057	6.5067	-40.117	0.5761	2.6465	-2.1309	5.4405	-38.6592	-6.0805	7.5729	-41.5748
0.304	-2.9741	6.44	-41.7309	0.8724	2.584	-1.4571	5.4941	-39.6013	-4.491	7.3859	-43.8604
0.32	-2.2436	6.8274	-42.7151	1.0026	1.9712	-1.7171	5.5837	-40.5995	-2.77	8.0712	-44.8306
0.336	-1.4401	6.9402	-44.109	1.1456	1.6995	-1.3047	5.8941	-41.7793	-1.5755	7.9862	-46.4387
0.352	-1.2436	6.8809	-44.5002	1.0717	1.0402	-1.9445	5.6864	-41.9593	-0.5427	8.0754	-47.0411
0.368	0.4529	7.5002	-44.9846	0.8185	0.5106	-1.149	6.6028	-43.0225	2.0549	8.3976	-46.9466
0.384	0.8759	7.2423	-45.7328	0.6931	0.1866	-1.7932	6.7384	-43.4766	3.5451	7.7462	-47.989
0.4	2.0118	7.5698	-46.2236	0.4937	0.2196	-1.219	6.8487	-44.4423	5.2427	8.2909	-48.0049
0.416	2.7756	8.0248	-46.4869	0.2828	0.1827	-0.0943	7.4945	-45.6388	5.6454	8.555	-47.3351
0.432	3.651	7.4111	-47.5835	0.2171	0.0842	0.6218	7.1556	-46.913	6.6802	7.6667	-48.254
0.448	4.0563	8.0734	-47.7931	0.1377	0.1673	0.9082	7.5417	-47.3507	7.2044	8.605	-48.2354
0.464	5.1393	7.8104	-48.7266	0.0738	0.1552	1.6772	7.2686	-48.4676	8.6014	8.3522	-48.9856
0.48	5.2411	8.3173	-48.6758	-0.1664	0.1625	2.0056	7.7869	-49.2263	8.4766	8.8477	-48.1252
0.496	5.4177	8.1664	-49.2053	-0.1475	0.0594	1.6095	7.9398	-49.7723	9.226	8.3931	-48.6383
0.512	6.5084	7.9405	-50.3959	-0.2215	0.1911	3.4886	7.3562	-51.0884	9.5282	8.5248	-49.7034
0.528	6.6343	8.0923	-50.8455	-0.3254	0.1366	3.2678	7.6294	-51.9921	10.0008	8.5551	-49.699
0.544	7.7798	8.7612	-51.8065	-0.3619	0.0643	4.7289	8.5649	-52.9641	10.8307	8.9575	-50.6489
0.56	7.8642	8.848	-52.747	-0.5007	-0.0562	5.1567	9.0004	-54.2307	10.5716	8.6957	-51.2632
0.576	8.2995	9.4671	-53.3455	-0.3175	-0.1785	4.8865	10.083	-54.4853	11.7125	8.8512	-52.2057
0.592	8.8733	9.2363	-54.6968	-0.4773	-0.098	6	9.5188	-56.1902	11.7466	8.9538	-53.2035
0.608	9.1312	9.801	-55.0581	-0.3864	-0.1668	5.6687	10.3839	-56.4868	12.5938	9.2181	-53.6295
0.624	8.9943	9.6596	-55.8635	-0.5454	-0.2454	6.2955	10.3355	-57.5516	11.693	8.9837	-54.1754
0.64	10.2923	10.3165	-57.4438	-0.3843	-0.2157	7.0982	11.0163	-58.7663	13.4865	9.6166	-56.1213

Ma14

time	pos(x)	pos(y)	pos(z)	el	az	x1	y1	z1	x2	y2	z2
0.656	11.984	10.2737	-59.3626	-0.3507	-0.2103	8.2124	11.0788	-60.7734	15.7555	9.4686	-57.9519
0.672	11.8323	10.545	-60.1421	-0.3573	-0.1859	8.4009	11.1903	-61.4455	15.2637	9.8997	-58.8386
0.688	12.6639	10.8993	-61.1859	-0.3093	-0.2642	9.0883	11.8665	-62.3697	16.2396	9.9322	-60.0021
0.704	13.0261	10.9841	-63.0213	-0.423	-0.2285	9.8084	11.7326	-64.5085	16.2438	10.2357	-61.534
0.72	14.0314	11.0377	-64.4934	-0.4391	-0.2098	10.9044	11.7034	-65.995	17.1583	10.3719	-62.9917
0.736	14.3285	11.4914	-65.8072	-0.4527	-0.2063	11.2402	12.1378	-67.3417	17.4168	10.8449	-64.2726
0.752	14.8114	11.8733	-66.8541	-0.4469	-0.1885	11.9158	12.4257	-68.2668	17.7071	11.321	-65.4415
0.768	16.2647	12.0028	-68.6938	-0.4978	-0.175	13.0139	12.5775	-70.4877	19.5154	11.428	-66.8998
0.784	17.4378	12.7167	-70.0463	-0.4168	-0.1315	13.9778	13.1744	-71.5917	20.8979	12.259	-68.5009
0.8	18.3048	12.8243	-71.6576	-0.6154	-0.0441	15.4364	12.951	-73.6877	21.1733	12.6976	-69.6274
0.816	20.0691	13.0293	-74.2556	-0.6591	-0.0509	17.5436	13.1579	-76.2144	22.5945	12.9007	-72.2969
0.832	21.2975	13.0682	-76.0501	-0.5225	-0.0581	18.2891	13.2433	-77.7856	24.3059	12.8931	-74.3146
0.848	22.1291	13.5625	-77.7869	-0.4495	-0.0863	18.7908	13.8513	-79.4035	25.4674	13.2737	-76.1702
0.864	23.6695	15.1158	-78.2709	-0.1436	-0.3226	20.8514	16.0577	-78.7006	26.4876	14.1739	-77.8412
0.88	24.5019	14.8126	-80.8121	-0.31	0.0523	20.6155	14.609	-82.0587	28.3884	15.0162	-79.5654
0.896	24.7085	15.5306	-82.8479	0.09	-0.0295	20.8799	15.6436	-82.5024	28.5371	15.4176	-83.1935
0.912	25.8448	15.6189	-84.2934	0.053	0.007	22.1845	15.5934	-84.099	29.505	15.6444	-84.4877
0.928	25.0051	16.3378	-86.4903	0.1751	0.1505	22.1439	15.9039	-85.9785	27.8663	16.7716	-87.0022
0.944	26.0851	16.8074	-88.3498	0.7411	0.2174	23.5648	16.2508	-85.988	28.6054	17.3641	-90.7116
0.96	26.2467	17.062	-90.2827	0.8454	0.2062	23.9936	16.5908	-87.6866	28.4999	17.5332	-92.8787
0.976	26.5208	17.8948	-92.1365	0.9606	-0.0881	24.683	18.0571	-89.4978	28.3586	17.7325	-94.7752
0.992	25.8442	17.8613	-94.1961	1.0812	0.437	24.6477	17.3024	-91.7181	27.0406	18.4201	-96.674
1.008	24.9558	17.782	-95.5504	1.3772	2.3878	25.3838	17.3801	-92.5558	24.5277	18.1838	-98.5449
1.024	24.3633	18.521	-97.5195	1.2944	2.3735	25.0028	17.9032	-94.3841	23.7237	19.1388	-100.6548
1.04	23.1215	18.4779	-98.5088	0.9914	2.4166	24.4734	17.2802	-95.7482	21.7696	19.6755	-101.2694
1.056	22.271	18.8583	-98.9554	0.7963	2.6633	24.3174	17.7972	-96.5994	20.2246	19.9193	-101.3114
1.072	21.4829	19.3265	-99.5258	0.5377	2.8113	24.1981	18.3957	-97.8143	18.7677	20.2574	-101.2373
1.088	21.086	20.4575	-99.827	0.5015	2.7212	23.6453	19.3134	-98.29	18.5266	21.6016	-101.364
1.104	20.917	20.9031	-100.8954	0.3961	2.7721	24.2516	19.6116	-99.4	17.5824	22.1946	-102.3907
1.12	20.116	20.6319	-101.1497	0.1482	2.9766	23.7164	20.0326	-100.6052	16.5175	21.2313	-101.6942
1.136	19.5442	20.9652	-101.865	0.122	2.9162	24.0021	19.9431	-101.3045	15.0863	21.9873	-102.4256
1.152	19.0692	21.0386	-102.4816	0.07	3.0025	23.3089	20.4449	-102.1815	14.8294	21.6323	-102.7817
1.168	19.4637	21.2701	-103.3856	0.1052	2.9478	23.04	20.5681	-103.0009	15.8873	21.972	-103.7702
1.184	19.6286	21.2307	-104.7024	0.1852	2.9548	22.5916	20.6707	-104.1375	16.6655	21.7908	-105.2672
1.2	19.8235	22.3959	-106.2207	0.0939	3.0059	23.7126	21.8648	-105.851	15.9343	22.927	-106.5903
1.216	19.4288	22.5645	-106.9684	0.0591	2.9176	22.9404	21.7646	-106.7551	15.9172	23.3644	-107.1816
1.232	19.1353	23.5267	-108.0055	-0.0362	2.9921	23.375	22.8879	-108.161	14.8956	24.1655	-107.8501
1.248	19.4177	23.2935	-109.315	-0.0294	3.0168	23.3589	22.799	-109.432	15.4766	23.788	-109.198
1.264	18.8545	23.5019	-110.9417	-0.0315	2.9928	22.8421	22.9043	-111.0688	14.867	24.0995	-110.8147
1.28	18.2924	24.6078	-112.6004	-0.0252	2.9941	22.9272	23.9194	-112.7186	13.6576	25.2963	-112.4821
1.296	18.0459	24.8785	-113.8688	-0.0482	3.0225	22.722	24.3188	-114.0962	13.3698	25.4382	-113.6415
1.312	18.5108	25.2707	-115.3148	-0.1377	3.0775	23.033	24.9803	-115.9428	13.9887	25.561	-114.6868
1.328	17.6527	25.4126	-117.458	0.0626	3.0353	21.9558	24.9533	-117.1866	13.3497	25.8718	-117.7295
1.344	17.9736	26.1631	-118.3756	-0.075	3.0366	22.5517	25.6809	-118.7215	13.3955	26.6453	-118.0297
1.36	16.1464	26.9455	-120.7274	-0.0208	3.0047	21.6026	26.1941	-120.8422	10.6902	27.6969	-120.6125
1.376	16.5828	26.664	-122.5425	-0.0509	2.9813	22.0195	25.7853	-122.8228	11.1462	27.5427	-122.2622
1.392	16.2707	27.772	-124.5353	-0.0933	3.0182	21.0863	27.1748	-124.9894	11.4551	28.3692	-124.0812
1.408	15.8137	28.1398	-126.5035	-0.0515	2.9393	20.3316	27.2129	-126.7411	11.2958	29.0666	-126.2659
1.424	15.1088	28.3397	-128.382	0.0187	2.9639	20.3133	27.405	-128.283	9.9043	29.2744	-128.481
1.44	14.9627	28.76	-130.9821	0.2117	2.9154	19.5711	27.6994	-129.9658	10.3542	29.8206	-131.9983
1.456	14.9704	29.0875	-133.2427	0.2746	2.9356	19.5826	28.1236	-131.9152	10.3582	30.0515	-134.5702
1.472	14.2206	29.2551	-136.1664	0.4376	2.8407	18.1912	28.0228	-134.2215	10.25	30.4874	-138.1113
1.488	15.2625	29.6587	-137.8593	0.4705	2.6864	18.475	28.0861	-136.0402	12.05	31.2312	-139.6783
1.504	14.9052	29.8853	-140.8272	0.704	2.7298	17.9168	28.57	-138.0367	11.8937	31.2006	-143.6177
1.52	15.7855	30.2595	-142.7749	0.943	2.5034	17.6235	28.896	-139.6217	13.9475	31.6229	-145.9281
1.536	16.1498	30.9864	-144.8185	1.1995	2.1536	16.9332	29.798	-141.1632	15.3665	32.1748	-148.4739
1.552	18.6829	31.2137	-146.946	1.2597	2.0252	19.154	30.2494	-143.6085	18.2118	32.1781	-150.2835
1.568	20.2236	31.2619	-148.0318	1.2947	1.0399	19.7315	30.4239	-144.6016	20.7156	32.1	-151.4621
1.584	23.4811	29.8804	-148.8552	0.7816	0.1086	20.071	29.5086	-145.4507	26.8912	30.2521	-152.2598
1.6	23.5697	30.5093	-149.467	0.7377	0.1576	20.7096	30.0546	-146.835	26.4298	30.9639	-152.0991
1.616	25.3839	31.6305	-150.3452	0.7708	0.0673	22.1348	31.4116	-147.1827	28.6329	31.8495	-153.5077
1.632	25.4914	31.6146	-151.2383	0.6258	-0.0194	21.8764	31.6848	-148.625	29.1064	31.5445	-153.8516
1.648	26.0757	31.6037	-151.431	0.5352	0.0352	22.1241	31.4645	-149.0867	30.0272	31.7429	-153.7753
1.664	26.2232	31.736	-151.9317	0.3968	0.0608	21.7979	31.4664	-150.0737	30.6484	32.0056	-153.7896
1.68	26.013	32.0278	-152.1953	0.1775	-0.0328	22.1781	32.1535	-151.507	29.848	31.9021	-152.8837
1.696	27.3233	31.6176	-152.9861	0.0424	-0.0412	22.6752	31.8094	-152.7887	31.9713	31.4258	-153.1835

Ma14

time	pos(x)	pos(y)	pos(z)	el	az	x1	y1	z1	x2	y2	z2
1.712	27.7633	31.7496	-153.9086	-0.0318	-0.0461	23.5398	31.9446	-154.0433	31.9868	31.5546	-153.774
1.728	28.0401	31.8868	-154.6026	-0.1752	-0.0775	22.9786	32.2798	-155.501	33.1016	31.4939	-153.7042
1.744	28.8321	31.6366	-155.8717	-0.2065	0.013	23.9558	31.5733	-156.8933	33.7083	31.6998	-154.8501
1.76	29.2115	31.4448	-156.8411	-0.3237	0.0049	24.7883	31.423	-158.3251	33.6346	31.4666	-155.3571
1.776	29.803	31.6981	-158.3407	-0.356	-0.1021	25.2198	32.1676	-160.0535	34.3861	31.2286	-156.6278
1.792	31.0235	31.8854	-159.6239	-0.4205	-0.1736	26.5078	32.6775	-161.6738	35.5392	31.0933	-157.574
1.808	30.9839	31.8289	-161.1463	-0.6059	-0.1763	27.2875	32.4875	-163.7478	34.6803	31.1703	-158.5448
1.824	33.4608	31.5441	-162.0781	-0.4547	-0.1545	28.9321	32.2495	-164.3189	37.9895	30.8388	-159.8373
1.84	33.4162	31.9516	-162.9941	-0.6303	-0.1817	29.5804	32.6561	-165.8392	37.2519	31.247	-160.1489
1.856	34.208	32.1764	-164.8187	-0.5341	-0.1863	30.5281	32.8699	-167.0335	37.8879	31.4828	-162.604
1.872	35.2984	31.9502	-166.5246	-0.7094	-0.2238	32.4652	32.5951	-169.0191	38.1315	31.3052	-164.0301
1.888	36.2406	32.3712	-168.2939	-0.69	-0.2512	33.1424	33.1664	-170.9336	39.3388	31.5761	-165.6541
1.904	36.1771	32.5977	-168.7081	-0.6979	-0.2739	33.2285	33.426	-171.2769	39.1257	31.7693	-166.1393
1.92	38.0805	32.651	-170.1961	-0.9511	-0.3012	36.1041	33.265	-173.097	40.0569	32.037	-172.2952
1.936	39.8384	32.8204	-172.0736	-0.8306	-0.1553	36.6649	33.3171	-175.5905	43.012	32.3237	-168.5567
1.952	40.5128	32.658	-173.0604	-0.7458	-0.0757	37.1261	32.9147	-176.1982	43.8996	32.4012	-169.9227
1.968	42.683	32.6641	-173.7539	-0.8077	-0.1577	39.8026	33.122	-176.8035	45.5633	32.2062	-170.7042
1.984	43.4857	33.3619	-175.6276	-0.9129	-0.1577	40.8694	33.778	-179.056	46.102	32.9457	-172.1991
2	44.1076	33.873	-177.249	-1.1621	-0.4632	42.6182	34.6169	-181.0928	45.597	33.129	-173.4051
2.016	47.267	33.7738	-178.3241	-1.1777	-0.2707	45.9427	34.1414	-181.6382	48.5914	33.4063	-175.01
2.032	48.3666	33.919	-179.3629	-1.3988	-0.3509	47.7267	34.1533	-183.2851	49.0066	33.6848	-175.4407
2.048	49.9874	33.5858	-180.9231	-1.4052	-0.2485	49.3275	33.7533	-184.9955	50.6472	33.4184	-176.8507
2.064	52.4258	33.8952	-181.7575	-1.4955	-2.4858	52.6456	34.0643	-185.4334	52.206	33.7261	-178.0816
2.08	54.6733	32.9715	-182.6756	-1.5243	-1.2048	54.6084	33.1409	-186.5756	54.7382	32.802	-178.7755
2.096	55.0947	32.6416	-183.6696	-1.5174	2.0364	55.1818	32.4681	-187.3023	55.0075	32.815	-180.037
2.112	57.2555	32.5927	-184.042	-1.4856	2.357	57.4692	32.3794	-187.5771	57.0418	32.8061	-180.5069
2.128	60.6574	34.9798	-185.4007	-1.4887	-2.0335	60.7662	35.1979	-188.362	60.5486	34.7617	-182.4393
2.144	61.6031	34.7779	-186.0822	-1.3317	-3.0081	62.3919	34.8838	-189.3476	60.8144	34.672	-182.8167
2.16	63.9137	35.0664	-186.34	-1.5518	-2.4353	63.9664	35.1113	-189.9855	63.861	35.0214	-182.6946
2.176	64.3557	35.0636	-186.6715	-1.2899	3.0275	65.3615	34.9483	-190.1795	63.35	35.1788	-183.1636
2.192	65.7195	34.8044	-188.0082	-1.1127	-2.8684	67.2776	35.2411	-191.2899	64.1614	34.3677	-184.7266
2.208	68.4985	35.3824	-188.4361	-1.0611	-3.0486	70.3869	35.5585	-191.829	66.6102	35.2064	-185.0432
2.224	68.7143	35.482	-188.2954	-0.9415	-3.059	71.043	35.6748	-191.5051	66.3856	35.2891	-185.0857
2.24	69.055	34.68	-188.9537	-0.916	-2.9486	71.3542	35.1293	-192.0051	66.7558	34.2306	-185.9022
2.256	69.8244	35.3297	-189.5682	-0.7222	-3.0574	73.0779	35.6043	-192.4444	66.5709	35.0551	-186.692
2.272	70.5329	35.8221	-190.9722	-0.7479	-3.0632	73.0087	36.0165	-193.2759	68.057	35.6277	-188.6685
2.288	72.2421	35.9485	-192.0995	-0.7884	-3.0862	74.2346	36.059	-194.1072	70.2496	35.838	-190.0917
2.304	73.281	35.9364	-192.3038	-0.7603	-3.093	75.7232	36.0552	-194.6292	70.8388	35.8175	-189.9785
2.32	74.891	36.4308	-192.8561	-0.6245	-2.9599	77.7041	36.9476	-194.9176	72.078	35.914	-190.7946
2.336	75.771	37.2204	-194.0483	-0.6825	-3.0832	78.2537	37.3656	-196.0698	73.2882	37.0753	-192.0267
2.352	74.9805	37.3175	-196.0592	-0.1606	3.0167	79.7489	36.7187	-196.8379	70.2121	37.9163	-195.2805
2.368	75.4009	37.4688	-196.365	-0.4482	3.0717	79.4616	37.1844	-198.3223	71.3401	37.7532	-194.4078
2.384	76.583	37.393	-197.5335	-0.4456	-3.1393	80.8036	37.4028	-199.5496	72.3624	37.3831	-195.5174
2.4	76.9815	37.5782	-197.8486	-0.5357	3.0994	80.8218	37.4161	-200.1304	73.1413	37.7404	-195.5669
2.416	79.4665	37.6831	-199.1169	-0.6301	3.137	83.4065	37.6649	-201.99	75.5266	37.7013	-196.2439
2.432	78.8954	38.264	-200.0041	-0.4841	3.0262	82.8863	37.8014	-202.1169	74.9045	38.7266	-197.8913
2.448	80.0021	38.8578	-200.715	-0.6074	3.049	83.3441	38.5475	-203.0479	76.66	39.1681	-198.3821
2.464	79.9182	38.1568	-201.7647	-0.4835	3.0304	84.3457	37.6622	-204.1039	75.4907	38.6513	-199.4255
2.48	80.307	38.5503	-201.7255	-0.6327	3.1165	84.5322	38.4444	-204.8247	76.0818	38.6561	-198.6263
2.496	80.1645	39.0493	-203.5292	-0.5771	3.0791	84.7561	38.7618	-206.5241	75.573	39.3368	-200.5344
2.512	81.6137	38.1284	-203.5361	-0.6469	-3.061	85.4638	38.4393	-206.4538	77.7636	37.8175	-200.6183
2.528	80.9589	38.8187	-205.0141	-0.5395	3.0198	85.6783	38.2412	-207.8611	76.2396	39.3963	-202.167
2.544	81.2513	39.0877	-203.63	-0.6686	-3.0909	85.0484	39.2804	-206.6332	77.4542	38.8951	-200.6267
2.56	83.0055	39.1769	-205.3055	-0.5716	3.1408	87.4572	39.1734	-208.169	78.5537	39.1804	-202.442
2.576	83.9563	38.6288	-207.2205	-0.6277	-3.0219	88.7551	39.2059	-210.7278	79.1574	38.0518	-203.7132
2.592	82.9474	38.9326	-208.0513	-0.8028	-2.9195	86.3653	39.7046	-211.6792	79.5295	38.1607	-204.4234
2.608	83.5088	39.0625	-209.3025	-0.7043	-2.9788	87.6352	39.7404	-212.8556	79.3825	38.3846	-205.7493
2.624	83.032	39.0833	-210.8588	-1.0008	-2.7475	85.4029	40.0692	-214.8651	80.661	38.0975	-206.8526
2.64	83.2037	40.1379	-211.6717	-1.1389	-2.6785	85.1395	41.1045	-216.3659	81.2678	39.1712	-206.9776
2.656	83.6192	40.0357	-212.414	-1.1484	-2.5042	85.2299	41.2285	-216.8739	82.0084	38.8429	-207.954
2.672	82.3871	39.166	-214.4411	-1.1737	-2.5674	84.093	40.2696	-219.2859	80.6812	38.0623	-209.5962
2.688	83.0334	39.7107	-215.7614	-1.1464	-2.5802	84.7193	40.7711	-220.1693	81.3475	38.6504	-211.3536
2.704	83.1053	40.31	-216.5727	-1.1438	-2.4679	84.5149	41.4353	-220.5372	81.6957	39.1846	-212.6081
2.72	83.2376	39.9366	-218.236	-1.0665	-2.4111	84.8123	41.3472	-222.0667	81.6629	38.5259	-214.4052
2.736	83.6657	41.1285	-219.4751	-1.0196	-2.5144	85.5061	42.4626	-223.1728	81.8253	39.7944	-215.7774
2.752	84.2443	39.9256	-221.2195	-1.1213	-2.6123	85.897	40.8925	-225.1885	82.5915	38.9588	-217.2505

Ma14

time	pos(x)	pos(y)	pos(z)	el	az	x1	y1	z1	x2	y2	z2
2.768	83.5512	41.0931	-222.0179	-1.1434	-1.7635	83.8579	42.6651	-225.534	83.2445	39.5211	-218.5019
2.784	83.5741	41.388	-222.0164	-1.0975	-1.8968	84.2237	43.3093	-225.9773	82.9245	39.4666	-218.0556
2.8	83.7067	41.0357	-223.4398	-1.1349	-1.6956	83.9221	42.752	-227.1538	83.4914	39.3194	-219.7259
2.816	83.3286	41.118	-224.9193	-1.0239	-1.8644	84.0076	43.3635	-228.772	82.6497	38.8725	-221.0667
2.832	83.8536	41.9937	-225.4111	-1.2233	-1.8965	84.305	43.3303	-229.3055	83.4023	40.6571	-221.5167
2.848	83.5356	40.785	-225.7392	-1.3045	-1.8412	83.8245	41.8274	-229.7044	83.2466	39.7426	-221.774
2.864	83.7314	40.7893	-227.9259	-1.3096	-1.7013	83.8658	41.8132	-231.7887	83.597	39.7654	-224.0632
2.88	84.7624	41.4213	-228.8263	-0.9367	-1.9505	85.7039	43.7805	-232.2801	83.8208	39.0622	-225.3724
2.896	84.9844	41.7043	-231.01	-0.9198	-2.0418	86.038	43.7734	-234.0579	83.9309	39.6351	-227.9622
2.912	85.4114	42.0806	-231.8455	-0.9855	-1.7437	85.807	44.3466	-235.3161	85.0158	39.8147	-228.3748
2.928	83.1635	41.9301	-233.2434	-0.8938	-1.5279	83.0347	44.9296	-236.9788	83.2923	38.9306	-229.5079
2.944	83.4116	41.2965	-233.5344	-0.9775	-1.389	82.9659	43.7211	-237.1903	83.8573	38.8718	-229.8785
2.96	82.5468	40.771	-234.8216	-1.1356	-1.3262	82.078	42.649	-238.9845	83.0156	38.8929	-230.6588
2.976	82.4528	41.4256	-235.6866	-0.8015	-1.0843	81.0332	44.1099	-238.8224	83.8724	38.7414	-232.5507
2.992	82.8964	40.1773	-236.4069	-1.0541	-1.4011	82.5493	42.2032	-240.0246	83.2435	38.1514	-232.7892
3.008	83.9135	41.5857	-238.3399	-0.9425	-1.547	83.8584	43.8976	-241.5232	83.9686	39.2739	-235.1566
3.024	83.1454	40.5565	-238.5669	-1.0782	-0.907	82.0642	41.9387	-241.8367	84.2267	39.1743	-235.2971
3.04	83.0622	42.6595	-240.5616	-1.1743	-1.1612	82.4643	44.0369	-244.1479	83.6602	41.2822	-236.9754
3.056	83.2094	41.4845	-241.6394	-1.0444	-1.0788	82.1606	43.4411	-245.4595	84.2581	39.5278	-237.8194
3.072	83.3711	40.0898	-242.2547	-1.1089	-0.4181	81.9064	40.7406	-245.4746	84.8358	39.439	-239.0347
3.088	83.7642	40.9462	-244.2182	-1.0963	-0.6255	82.3429	41.9727	-247.6314	85.1856	39.9196	-240.8051
3.104	83.4609	40.4194	-245.0238	-1.0958	-0.6824	82.0793	41.5422	-248.4856	84.8426	39.2966	-241.562
3.12	83.2625	39.9582	-245.8395	-1.3085	-0.7408	83.5395	40.6195	-249.4886	83.9856	39.2969	-242.1904
3.136	84.3589	39.893	-247.6181	-1.1597	-1.2514	83.7909	41.6102	-251.7675	84.9268	38.1757	-243.4687
3.152	83.4197	40.0627	-248.4268	-1.1449	-1.4001	83.1685	41.5199	-251.6866	83.6709	38.6055	-245.1669
3.168	84.3313	39.0254	-249.2237	-0.9621	-0.1189	82.1666	39.2841	-252.3518	86.496	38.7667	-246.0955
3.184	84.7589	37.576	-251.4621	-1.1369	-0.0733	83.0929	37.6983	-255.0672	86.4249	37.4537	-247.8569
3.2	86.2302	37.9818	-252.5564	-1.0737	0.0152	84.4303	37.9544	-255.8744	88.0301	38.0091	-249.2384
3.216	86.5314	37.4355	-252.8978	-1.212	0.1779	85.2628	37.2074	-256.3346	87.8	37.6636	-249.461
3.232	86.3701	37.178	-252.9424	-0.8851	0.1354	83.8285	36.8317	-256.0779	88.9116	37.5243	-249.807
3.248	84.9847	36.7821	-254.5227	-1.1837	0.3625	83.5631	36.243	-258.252	86.4063	37.3212	-250.7935
3.264	85.141	36.9484	-255.6045	-1.108	0.4806	83.5383	36.1127	-259.2272	86.7436	37.784	-251.9819
3.28	82.6718	37.3425	-255.8935	-1.1618	0.6538	81.1714	36.1929	-260.2546	84.1723	38.4921	-251.5325
3.296	83.8446	36.7361	-257.4084	-1.0076	0.6891	82.049	35.2569	-261.0929	85.6402	38.2152	-253.724
3.312	83.5093	36.0461	-259.0678	-1.2225	0.6591	82.3787	35.1703	-263.0066	84.6398	36.9219	-255.1291
3.328	84.5773	35.9784	-259.9857	-1.0271	0.6997	83.0267	34.6733	-263.3387	86.1278	37.2836	-256.6327
3.344	83.4433	36.5646	-260.9216	-1.1779	0.7815	82.3398	35.4697	-264.6721	84.5468	37.6596	-257.1711
3.36	84.4321	36.2804	-262.3992	-1.0644	0.7722	82.9742	34.8606	-266.0684	85.8899	37.7003	-258.73
3.376	83.7524	35.8738	-263.1738	-0.9603	0.8586	82.2765	34.1641	-266.402	85.2283	37.5835	-259.9455
3.392	86.0981	35.9273	-264.3363	-0.8774	0.78	84.4639	34.3106	-267.1024	87.7324	37.544	-261.5701
3.408	84.6084	36.0764	-265.685	-0.9883	0.8562	83.1607	34.4075	-269.0386	86.0562	37.7453	-262.3315
3.424	86.5551	36.4045	-266.7542	-0.924	0.9582	85.1742	34.4394	-269.935	87.936	38.3695	-263.5734
3.44	86.4541	35.6925	-267.5169	-1.1955	0.7438	85.4142	34.7357	-271.1039	87.494	36.6493	-263.9299
3.456	87.3163	35.9895	-268.5507	-1.0812	0.9562	86.1386	34.3208	-272.384	88.494	36.6581	-264.7175
3.472	88.2644	35.862	-269.6685	-0.9505	0.967	86.9944	34.0207	-272.7999	89.5345	37.7034	-266.5372
3.488	88.7767	35.9893	-271.2592	-1.0329	1.0278	87.9646	34.6437	-273.894	89.5887	37.335	-268.6245
3.504	88.24	35.4645	-272.1642	-0.9874	1.024	87.269	33.8694	-274.9935	89.2109	37.0597	-269.3349
3.52	88.0308	34.886	-272.7133	-1.183	1.1513	87.5173	33.7346	-275.7995	88.5442	36.0373	-269.6271
3.536	87.9394	33.0177	-272.6172	-1.1401	1.1968	87.4264	31.7105	-275.6734	88.4524	34.3249	-269.561
3.552	86.7694	34.4577	-274.8533	-0.9882	1.9785	87.4036	32.9894	-277.2809	86.1353	35.9261	-272.4256
3.568	88.3334	35.1605	-276.1062	-0.8911	1.9659	89.1057	33.3085	-278.589	87.5611	37.0124	-273.6234
3.584	88.8055	34.6717	-277.1621	-0.8161	2.2137	90.103	32.9397	-279.4633	87.508	36.4036	-274.8609
3.6	87.3154	34.1514	-277.1308	-0.7708	2.0338	88.5123	31.7537	-279.7333	86.1186	36.549	-274.5284
3.616	88.2575	32.4277	-278.6354	-0.9867	2.5422	89.5682	31.5322	-281.0365	86.9469	33.3233	-276.2343
3.632	89.4554	32.7136	-280.0757	-1.0218	2.2585	90.3389	31.638	-282.3511	88.5718	33.7893	-277.8004
3.648	90.329	32.9458	-280.6002	-0.9018	2.5758	91.9956	31.8874	-283.0974	88.6623	34.0042	-278.103
3.664	90.1502	32.6338	-281.2712	-1.084	1.978	90.7634	31.212	-284.1968	89.5369	34.0556	-278.3457
3.68	91.2144	33.2943	-282.2516	-1.0706	2.237	92.2339	31.9972	-285.2704	90.1948	34.5915	-279.2328
3.696	92.2099	33.2756	-283.2424	-0.9272	2.5568	94.09	32.0309	-286.2482	90.3297	34.5202	-280.2366
3.712	90.6592	33.676	-285.1472	-1.2295	2.5903	91.6306	33.0787	-288.3573	89.6878	34.2733	-281.9371
3.728	91.4839	33.2285	-286.4604	-0.988	2.4616	93.2494	31.8008	-289.9047	89.7184	34.6562	-283.0161
3.744	92.905	31.4983	-287.3964	-0.8026	2.6034	94.7361	30.4053	-289.6034	91.074	32.5914	-285.1894
3.76	93.9057	31.8633	-289.7177	-1.0151	3.1317	95.871	31.8437	-292.8826	91.9403	31.8828	-286.5529
3.776	92.9937	32.1467	-290.8307	-0.9812	2.8671	94.554	31.7073	-293.2539	91.4334	32.5861	-288.4076
3.792	93.9806	32.6212	-291.2825	-0.8788	2.9305	96.1754	32.1508	-293.9914	91.7858	33.0917	-288.5737
3.808	93.6706	33.2343	-290.6216	-1.0192	2.7263	95.3365	32.4998	-293.5809	92.0046	33.9689	-287.6622

Ma14

time	pos(x)	pos(y)	pos(z)	el	az	x1	y1	z1	x2	y2	z2
3.824	95.043	34.0658	-291.9491	-1.0613	2.657	96.7924	33.1449	-295.488	93.2937	34.9868	-288.4102
3.84	95.8008	34.6018	-293.4021	-0.9908	2.6073	97.5677	33.5562	-296.5359	94.0338	35.6474	-290.2684
3.856	95.685	35.2718	-294.2006	-0.9596	2.9979	98.1915	34.9092	-297.8148	93.1785	35.6344	-290.5864
3.872	96.0363	34.0431	-294.8173	-0.8099	3.1325	99.372	34.0128	-298.3204	92.7006	34.0734	-291.3141
3.888	95.9659	33.1889	-295.6656	-0.892	3.0078	98.7156	32.8189	-299.1048	93.2162	33.5589	-292.2265
3.904	97.0259	34.7198	-297.2908	-0.7441	3.0748	99.9303	34.5255	-299.9706	94.1214	34.914	-294.611
3.92	97.5866	33.6261	-299.3817	-0.7496	2.9555	100.1953	33.135	-301.8529	94.9779	34.1172	-296.9106
3.936	98.3762	33.7465	-299.8794	-0.8042	-3.0651	101.7693	34.0066	-303.4131	94.9831	33.4863	-296.3457
3.952	99.6741	36.0757	-302.4717	-0.8506	3.1303	102.1771	36.0473	-305.3244	97.171	36.104	-299.6191
3.968	97.7618	34.2202	-301.9111	-0.9047	2.8813	100.4503	33.5042	-305.4515	95.0734	34.9362	-298.3708
3.984	99.0617	34.9428	-303.8393	-0.9283	2.9412	101.093	34.5302	-306.6089	97.0304	35.3553	-301.0697
4	99.2424	35.1693	-304.2744	-0.8677	2.937	101.6034	34.6793	-307.119	96.8814	35.6593	-301.4297
4.016	99.8196	36.0349	-306.1793	-1.1167	3.1156	101.6917	35.9863	-310.0161	97.9476	36.0836	-302.3426
4.032	99.4103	33.4931	-306.0194	-0.9187	-2.9801	101.8708	33.8939	-309.2843	96.9499	33.0923	-302.7545
4.048	98.854	34.4121	-307.694	-1.1221	2.5632	99.7278	33.8416	-309.8614	97.9801	34.9826	-305.5266
4.064	98.3635	33.6043	-308.1358	-1.195	2.7771	99.4584	33.1866	-311.1057	97.2686	34.0221	-305.1658
4.08	99.959	33.7503	-309.7527	-1.2007	2.3193	100.6745	32.98	-312.4626	99.2435	34.5206	-307.0428
4.096	100.076	33.9596	-310.6494	-1.1262	2.5541	101.2271	33.193	-313.5522	98.9249	34.7261	-307.7466
4.112	99.7636	34.5917	-312.2938	-1.2217	2.789	100.8769	34.182	-315.553	98.6503	35.0013	-309.0345
4.128	99.9643	33.5902	-311.5989	-1.2308	-2.9489	101.0632	33.8047	-314.7637	98.8654	33.3758	-308.4341
4.144	99.5891	33.9801	-313.1524	-1.3601	2.7559	100.2838	33.698	-316.6581	98.8944	34.2622	-309.6467
4.16	99.6643	33.5303	-314.1797	-1.3701	-2.4503	100.1563	33.9374	-317.3193	99.1723	33.1231	-311.0401
4.176	98.8774	32.9531	-314.5171	-1.2219	-2.5744	99.9053	33.6078	-317.8671	97.8495	32.2984	-311.167
4.192	98.2445	32.6204	-314.9199	-1.131	-2.397	99.3626	33.6507	-318.1515	97.1264	31.5901	-311.6883
4.208	97.9049	32.5032	-316.0592	-1.0789	-2.5068	99.36	33.5747	-319.432	96.4499	31.4316	-312.6865
4.224	98.2397	32.3311	-317.6409	-1.0974	-2.543	99.6753	33.3103	-321.0336	96.8041	31.3518	-314.2482
4.24	97.539	31.804	-318.7946	-1.3556	-1.9299	97.7768	32.4374	-321.8903	97.3012	31.1705	-315.6989
4.256	96.4755	31.1535	-319.4059	-1.3957	-1.7917	96.6073	31.7403	-322.8062	96.3437	30.5666	-316.0056
4.272	95.9767	30.7295	-320.8815	-1.4172	-1.7151	96.0554	31.271	-324.4154	95.898	30.188	-317.3475
4.288	96.5633	30.8061	-321.9587	-1.3757	-2.0588	96.9142	31.4672	-325.7468	96.2123	30.1449	-318.1707
4.304	95.2233	30.2437	-322.3781	-1.4443	-0.2084	94.8019	30.3328	-325.7665	95.6448	30.1545	-318.9898
4.32	95.1464	29.9393	-323.8139	-1.4845	0.2655	94.8765	29.8659	-327.0479	95.4163	30.0127	-320.5798
4.336	94.7692	29.127	-324.3906	-1.5634	1.7054	94.7725	29.102	-327.7816	94.7658	29.1519	-320.9996
4.352	94.5682	29.6127	-325.4568	-1.4998	1.2703	94.494	29.3733	-328.9838	94.6424	29.8522	-321.9299

Manta

time	pos(x)	pos(y)	pos(z)	el	az	x1	y1	z1	x2	y2	z2
0.016	-1.2788	-0.0674	-5.6217	0.3606	0.1186	-4.3621	-0.4348	-4.4509	1.8046	0.3	-6.7926
0.032	-2.3205	1.016	-10.2357	0.4503	0.2362	-4.9142	0.3917	-8.9461	0.2731	1.6403	-11.5253
0.048	-3.5896	1.2289	-13.0123	0.5302	0.3682	-5.7119	0.41	-11.6789	-1.4672	2.0477	-14.3458
0.064	-4.7347	1.8045	-15.379	0.9864	2.3272	-3.9362	0.9583	-13.62	-5.5333	2.6508	-17.138
0.08	-6.3385	1.7298	-17.7552	0.0716	2.7863	-3.473	0.6665	-17.536	-9.2039	2.793	-17.9745
0.096	-6.9036	1.9856	-20.3218	0.1015	2.91	-3.0685	1.0812	-19.9205	-10.7387	2.89	-20.7231
0.112	-7.4732	1.33	-23.9284	0.3398	-3.1147	-3.5489	1.4354	-22.5407	-11.3974	1.2245	-25.3161
0.128	-8.0658	1.42	-25.933	0.0063	3.1239	-3.9476	1.3471	-25.907	-12.184	1.4928	-25.9589
0.144	-8.571	1.4846	-26.9641	-0.0732	-2.9611	-5.313	2.079	-27.2069	-11.829	0.8902	-26.7213
0.16	-8.7838	1.6009	-29.0237	-0.1583	-3.0355	-5.3874	1.9625	-29.5688	-12.1801	1.2393	-28.4786
0.176	-9.6884	1.8866	-30.7918	-0.1222	-2.8909	-6.645	2.666	-31.1776	-12.7317	1.1071	-30.406
0.192	-10.9438	2.9149	-32.3769	-0.2108	-2.9159	-8.3319	3.5147	-32.9504	-13.5557	2.315	-31.8035
0.208	-11.5512	2.9337	-33.873	-0.2263	-2.8142	-9.2892	3.7019	-34.4232	-13.8132	2.1654	-33.3229
0.224	-12.9329	3.4064	-35.6837	-0.1891	-2.978	-9.8324	3.9181	-36.285	-16.0334	2.8948	-35.0824
0.24	-13.3665	3.4388	-37.9466	-0.1293	-3.1164	-10.4801	3.5116	-38.3219	-16.2528	3.3661	-37.5713
0.256	-14.739	4.1405	-40.0411	-0.0485	3.0696	-10.3832	3.8266	-40.2531	-19.0948	4.4545	-39.8292
0.272	-15.3907	4.5409	-42.12	-0.0452	2.8243	-11.9765	3.4197	-42.2827	-18.8048	5.662	-41.9572
0.288	-15.9903	4.6371	-43.9096	0.0125	2.9328	-11.6336	3.714	-43.8538	-20.347	5.5602	-43.9655
0.304	-16.2694	4.3416	-46.415	0.3453	2.9482	-12.4459	3.593	-45.0135	-20.0929	5.0902	-47.8165
0.32	-15.934	4.4292	-48.6217	0.4828	2.7518	-13.0758	3.255	-47.002	-18.7921	5.6034	-50.2414
0.336	-14.9655	5.154	-50.4712	0.7899	2.7271	-12.9115	4.2502	-48.2066	-17.0195	6.0578	-52.7357
0.352	-14.9051	5.1335	-51.5187	1.1237	2.5416	-13.8893	4.4386	-48.9515	-15.9209	5.8284	-54.0858
0.368	-13.9731	5.0484	-53.1223	1.4135	1.2303	-14.1243	4.6218	-50.2689	-13.822	5.475	-55.9758
0.384	-13.8707	5.7729	-53.9051	1.1947	1.0143	-14.4197	4.8903	-51.2729	-13.3216	6.6555	-56.5374
0.4	-13.0478	6.0348	-54.1443	0.7788	0.3406	-15.0681	5.3187	-52.0289	-11.0276	6.7509	-56.2597
0.416	-12.2891	6.3265	-54.8691	0.7027	-0.0183	-15.4346	6.3842	-52.2044	-9.1435	6.2689	-57.5339
0.432	-11.102	6.5766	-55.5216	0.603	0.0479	-14.0721	6.4342	-53.474	-8.1319	6.7191	-57.5691

Ma15

time	pos(x)	pos(y)	pos(z)	el	az	x1	y1	z1	x2	y2	z2
0.448	-10.8867	6.5894	-55.9126	0.3554	0.2066	-13.8117	5.9764	-54.8034	-7.9617	7.2023	-57.0218
0.464	-10.2833	7.0999	-56.5136	0.1351	0.1741	-13.9215	6.4599	-56.0113	-6.6452	7.7399	-57.0159
0.48	-9.6111	6.968	-57.3237	0.1517	0.1879	-13.0254	6.3187	-56.7925	-6.1967	7.6174	-57.8549
0.496	-10.008	7.2957	-57.4929	0.0718	0.1224	-13.2917	6.8919	-57.2551	-6.7244	7.6996	-57.7307
0.512	-9.5799	7.4363	-58.658	0.0018	0.1658	-12.8792	6.8842	-58.652	-6.2806	7.9885	-58.664
0.528	-9.1871	7.4232	-59.3849	-0.0509	0.1808	-13.0484	6.7173	-59.585	-5.3258	8.129	-59.1848
0.544	-8.6736	6.8564	-59.9737	-0.0301	0.1412	-11.8609	6.4033	-60.0706	-5.4863	7.3095	-59.8767
0.56	-9.0348	7.3387	-61.3119	0.0215	0.0471	-13.1368	7.1455	-61.2237	-4.9328	7.532	-61.4002
0.576	-8.8803	7.827	-61.3269	0.0249	0.0009	-13.0802	7.8231	-61.2224	-4.6805	7.8309	-61.4315
0.592	-8.7764	8.2052	-62.5544	-0.029	0.1858	-12.3611	7.5314	-62.6602	-5.1916	8.879	-62.4486
0.608	-8.0185	8.0953	-64.3204	-0.0593	0.1181	-11.8784	7.6374	-64.551	-4.1586	8.5532	-64.0898
0.624	-7.714	8.3957	-65.1276	-0.0435	0.1596	-11.9312	7.7169	-65.3134	-3.4968	9.0745	-64.9418
0.64	-7.9439	8.3535	-66.6165	0.0015	0.3086	-11.3883	7.2553	-66.6112	-4.4995	9.4517	-66.6218
0.656	-7.8751	8.7315	-67.6043	-0.0174	0.1581	-11.1086	8.216	-67.6613	-4.6417	9.2469	-67.5474
0.672	-7.28	9.4153	-68.6757	0.1204	0.3707	-10.4018	8.2021	-68.2704	-4.1582	10.6285	-69.081
0.688	-7.3666	9.388	-70.6048	0.1749	0.4501	-9.9641	8.133	-70.095	-4.7692	10.643	-71.1146
0.704	-8.5086	9.9267	-72.0272	0.1923	0.5693	-10.7563	8.4883	-71.5077	-6.2608	11.3651	-72.5467
0.72	-8.5255	9.837	-73.4449	0.3298	0.3324	-10.8959	9.0188	-72.5864	-6.1552	10.6552	-74.3034
0.736	-8.4052	10.0954	-74.7505	0.5073	0.3108	-10.8716	9.3033	-73.3105	-5.9387	10.8876	-76.1905
0.752	-8.4577	10.6189	-75.7508	0.6116	0.3526	-11.2702	9.5841	-73.6492	-5.6452	11.6538	-77.8523
0.768	-9.3591	11.0526	-76.7833	0.8405	0.4804	-10.9822	10.2067	-74.7393	-7.736	11.8985	-78.8273
0.784	-8.719	11.9519	-77.579	0.7391	0.4696	-10.9482	10.8206	-75.3006	-6.4899	13.0833	-79.8573
0.8	-9.6158	11.9016	-79.0466	0.9464	0.4304	-11.289	11.1334	-76.4912	-7.9426	12.6698	-81.6019
0.816	-10.1739	12.05	-80.728	1.0404	0.6606	-11.485	11.0311	-77.8968	-8.8627	13.0689	-83.5592
0.832	-11.0614	12.6552	-81.7308	1.0722	1.1546	-11.6351	11.357	-79.1241	-10.4876	13.9534	-84.3375
0.848	-12.2161	12.8693	-82.994	1.0808	1.6048	-12.1658	11.3914	-80.2218	-12.2664	14.3472	-85.7662
0.864	-13.4016	12.7723	-84.3356	1.0782	2.0288	-12.7913	11.5342	-81.7636	-14.012	14.0103	-86.9075
0.88	-13.8275	12.5824	-85.8052	1.0093	2.4357	-12.6293	11.561	-83.3025	-15.0257	13.6038	-88.3079
0.896	-15.2145	12.9176	-85.846	0.84	2.6089	-13.1257	11.6862	-83.1408	-17.3034	14.1491	-88.5512
0.912	-15.1184	13.1258	-87.1636	0.8067	2.8259	-12.8196	12.3749	-84.6398	-17.4172	13.8767	-89.6873
0.928	-15.1988	12.9243	-87.9738	0.6305	2.8654	-12.0624	12.0354	-85.5943	-18.3352	13.8131	-90.3533
0.944	-16.0079	13.286	-88.6903	0.5213	2.9442	-12.1234	12.5092	-86.4154	-19.8924	14.0628	-90.9653
0.96	-16.3876	13.4743	-89.9538	0.5026	2.9844	-12.7558	12.8985	-87.9325	-20.0194	14.0501	-91.9751
0.976	-17.1943	13.8802	-90.6413	0.4817	2.8165	-12.9255	12.4413	-88.2862	-21.4631	15.3191	-92.9965
0.992	-17.7787	14.5539	-91.1355	0.4106	2.9345	-13.3215	13.6175	-89.1526	-22.2359	15.4904	-93.1184
1.008	-17.6237	14.1595	-92.6687	0.3415	3.0085	-12.9212	13.5299	-90.9824	-22.3262	14.789	-94.355
1.024	-18.547	13.8343	-93.5715	0.276	3.0827	-13.6915	13.5481	-92.1938	-23.4025	14.1204	-94.9493
1.04	-18.9239	13.8166	-92.5578	0.0364	2.9789	-14.5641	13.1009	-92.397	-23.2836	14.5323	-92.7187
1.056	-19.3604	14.142	-93.8732	0.0016	3.1167	-14.7965	14.0281	-93.8657	-23.9242	14.2558	-93.8807
1.072	-19.8635	14.3024	-94.9573	0.004	3.1284	-16.2752	14.2552	-94.9429	-23.4518	14.3496	-94.9716
1.088	-19.626	14.3176	-95.8471	-0.1007	-2.9957	-16.0897	14.8373	-96.2081	-23.1623	13.7979	-95.486
1.104	-20.7775	14.7763	-96.9711	-0.2884	-2.7895	-17.7978	15.871	-97.9128	-23.7573	13.6816	-96.0294
1.12	-20.3361	14.5104	-98.361	-0.1894	-2.7118	-17.9505	15.6039	-98.864	-22.7217	13.4169	-97.858
1.136	-21.048	14.0859	-99.3933	-0.2861	-2.7549	-18.4752	15.1335	-100.2106	-23.6208	13.0384	-98.576
1.152	-21.4625	14.6363	-100.0575	-0.3123	-2.7547	-19.3107	15.5131	-100.8077	-23.6144	13.7595	-99.3072
1.168	-21.6407	14.9709	-101.6354	-0.4686	-2.7539	-18.8262	16.1203	-103.1742	-24.4552	13.8215	-100.0965
1.184	-21.7777	14.922	-102.6815	-0.5493	-2.6259	-19.5068	16.2094	-104.2795	-24.0486	13.6346	-101.0835
1.2	-21.504	15.5114	-103.2638	-0.6732	-2.5488	-19.4791	16.8755	-105.2109	-23.529	14.1473	-101.3168
1.216	-22.8039	15.8988	-103.8614	-0.8546	-2.5476	-21.06	17.0767	-106.2791	-24.5478	14.721	-101.4436
1.232	-24.5989	16.7458	-104.1804	-0.873	-2.5592	-22.75	17.9634	-106.8204	-26.4478	15.5282	-101.5404
1.248	-24.0536	16.0567	-104.6762	-1.2365	-1.686	-23.9316	17.1114	-107.7333	-24.1756	15.0021	-101.6192
1.264	-25.1357	17.0283	-105.6467	-1.1985	-1.1078	-25.6994	18.1576	-108.8785	-24.572	15.899	-102.4149
1.28	-25.9087	17.2598	-107.3774	-1.3775	-0.8607	-26.3027	17.718	-110.4639	-25.5148	16.8016	-104.291
1.296	-26.3835	17.3231	-107.4611	-1.4365	-1.0961	-26.564	17.6745	-110.3841	-26.2029	16.9717	-104.538
1.312	-27.2952	17.6278	-108.4149	-1.1969	-0.7516	-28.0221	18.3072	-110.9509	-26.5683	16.9485	-105.879
1.328	-27.0047	17.9509	-109.3739	-1.0433	-0.2893	-28.5526	18.4116	-112.1465	-25.4568	17.4901	-106.6014
1.344	-27.2894	18.3154	-110.3481	-0.8835	-0.1837	-29.6326	18.7507	-113.2517	-24.9463	17.8801	-107.4445
1.36	-28.7203	18.8524	-110.6696	-0.9222	-0.2255	-30.8163	19.3331	-113.5064	-26.6243	18.3717	-107.8327
1.376	-28.7286	19.5077	-111.6698	-1.0656	-0.1081	-30.3628	19.6849	-114.6421	-27.0944	19.3304	-108.6975
1.392	-28.8546	19.9562	-112.5048	-0.9455	-0.167	-30.8177	20.2871	-115.2623	-26.8915	19.6254	-109.7474
1.408	-28.3584	19.3806	-113.5174	-0.843	-0.0002	-30.8376	19.3812	-116.3002	-25.8792	19.3801	-110.7347
1.424	-28.5293	20.1411	-114.512	-0.941	0.1107	-30.7296	19.8964	-117.5494	-26.3289	20.3857	-111.4745
1.44	-30.1324	20.2171	-115.9356	-0.8072	-0.0377	-32.81	20.3182	-118.7345	-27.4548	20.1161	-113.1368
1.456	-30.3024	19.7704	-116.6784	-0.7368	-0.1943	-33.6737	20.4337	-119.7955	-26.931	19.1071	-113.5613
1.472	-30.3953	20.4929	-116.8818	-0.7978	-0.076	-33.6694	20.7422	-120.2481	-27.1212	20.2435	-113.5154
1.488	-31.0119	20.2644	-117.7321	-0.7713	-0.106	-34.2119	20.6049	-120.8608	-27.8119	19.9239	-114.6034

Ma15

time	pos(x)	pos(y)	pos(z)	el	az	x1	y1	z1	x2	y2	z2
1.504	-31.7182	20.7764	-118.7051	-0.7478	-0.0979	-35.1817	21.1164	-121.9332	-28.2547	20.4364	-115.477
1.52	-31.3131	21.2831	-119.0439	-0.6744	-0.1683	-35.0738	21.9223	-122.0934	-27.5524	20.644	-115.9944
1.536	-31.9083	21.8887	-120.061	-0.7314	-0.126	-34.9728	22.277	-122.8333	-28.8438	21.5004	-117.2887
1.552	-32.0995	22.2445	-121.1942	-0.7662	-0.1631	-35.3414	22.7779	-124.356	-28.8575	21.7112	-118.0325
1.568	-31.964	22.3105	-122.5224	-0.7161	-0.2375	-35.3004	23.118	-125.5093	-28.6276	21.503	-119.5355
1.584	-33.0708	22.8927	-123.6687	-0.5926	-0.3787	-36.7165	24.3432	-126.3105	-29.425	21.4422	-121.0269
1.6	-32.6088	23.2521	-123.763	-0.6473	-0.3194	-36.182	24.4336	-126.6081	-29.0356	22.0705	-120.9178
1.616	-31.6209	23.6491	-124.8954	-0.6607	-0.3433	-35.0488	24.8743	-127.7244	-28.1931	22.4238	-122.0664
1.632	-32.8484	24.3213	-125.8743	-0.5757	-0.3826	-36.9758	25.9822	-128.762	-28.721	22.6605	-122.9866
1.648	-33.4403	25.0697	-126.0447	-0.6051	-0.3274	-37.0422	26.293	-128.6755	-29.8384	23.8464	-123.414
1.664	-33.5354	25.6852	-127.243	-0.633	-0.4091	-37.0825	27.2231	-130.0798	-29.9882	24.1474	-124.4063
1.68	-32.9226	25.8602	-127.8861	-0.5572	-0.3745	-36.5908	27.3021	-130.342	-29.2544	24.4182	-125.4301
1.696	-33.8954	26.6329	-128.5394	-0.7157	-0.4997	-36.8621	28.2526	-131.4782	-30.9286	25.0132	-125.6007
1.712	-33.658	26.7177	-129.4479	-0.7021	-0.5652	-36.6985	28.6459	-132.4935	-30.6174	24.7895	-126.4023
1.728	-33.4663	27.4935	-129.9912	-0.7055	-0.569	-36.1267	29.1949	-132.6807	-30.8059	25.792	-127.3016
1.744	-33.9605	27.9451	-130.9211	-0.7048	-0.5058	-36.5368	29.3718	-133.4258	-31.3842	26.5183	-128.4165
1.76	-33.588	28.7836	-132.5303	-0.7657	-0.6401	-35.9114	30.5137	-135.3151	-31.2647	27.0535	-129.7455
1.776	-32.7991	28.4037	-133.0203	-0.7693	-0.7129	-34.5633	29.9289	-135.2787	-31.0349	26.8784	-130.7619
1.792	-32.7628	29.6936	-133.2382	-0.6793	-0.831	-34.6776	31.7915	-135.5317	-30.848	27.5957	-130.9448
1.808	-33.4585	30.5159	-134.5256	-0.7574	-0.7407	-35.4974	32.3802	-137.1377	-31.4197	28.6515	-131.9134
1.824	-33.3277	30.6015	-135.1938	-0.748	-0.8703	-35.3356	32.983	-138.084	-31.3197	28.22	-132.3036
1.84	-32.3713	31.0541	-136.3394	-0.6854	-0.9287	-34.0661	33.3203	-138.6531	-30.6765	28.7879	-134.0257
1.856	-32.5138	31.6957	-136.5456	-0.6718	-0.8029	-34.8223	34.0866	-139.1883	-30.2053	29.3047	-133.903
1.872	-32.366	31.5234	-137.0339	-0.7495	-0.9588	-33.928	33.749	-139.5642	-30.8041	29.2979	-134.5037
1.888	-31.0806	31.3164	-138.5321	-0.7788	-1.4487	-31.3624	33.613	-140.8157	-30.7988	29.0197	-136.2486
1.904	-30.7151	31.7196	-139.0101	-0.7781	-1.273	-31.4465	34.1027	-141.4669	-29.9837	29.3365	-136.5533
1.92	-30.8403	32.746	-139.8984	-0.8188	-1.4549	-31.1215	35.1617	-142.4985	-30.5591	30.3303	-137.2982
1.936	-30.904	33.8125	-140.5871	-0.8499	-1.526	-31.006	36.0892	-143.1809	-30.8021	31.5359	-137.9933
1.952	-29.38	34.008	-141.5119	-0.7616	-1.8852	-28.6675	36.199	-143.7087	-30.0926	31.817	-139.315
1.968	-29.3083	34.2399	-142.3619	-0.7026	-1.7969	-28.6366	37.16	-144.8992	-29.9799	31.3198	-139.8245
1.984	-28.7422	34.1886	-143.1012	-0.8257	-1.9403	-27.9133	36.3288	-145.5895	-29.571	32.0483	-140.613
2	-28.8517	34.809	-143.0369	-0.9418	-2.0851	-27.9022	36.4894	-145.6898	-29.8013	33.1286	-140.384
2.016	-28.4011	34.6547	-144.4811	-0.7777	-2.2614	-26.7848	36.6108	-146.9798	-30.0175	32.6986	-141.9824
2.032	-27.1584	34.8172	-145.4223	-0.799	-2.2034	-25.6703	36.8471	-148.0087	-28.6464	32.7874	-142.8359
2.048	-27.0903	35.3155	-145.6071	-0.8545	-2.4488	-25.0825	36.9822	-148.6047	-29.0981	33.6488	-142.6096
2.064	-26.6905	36.2101	-146.5018	-0.8938	-2.5037	-24.6571	37.7173	-149.6511	-28.724	34.7029	-143.3524
2.08	-26.2897	36.6631	-147.9253	-0.6535	-2.1612	-24.5201	39.304	-150.3597	-28.0593	34.0223	-145.491
2.096	-26.235	36.972	-148.3817	-0.6828	-2.6592	-23.0149	38.6583	-151.3377	-29.455	35.2858	-145.4257
2.112	-25.508	35.9422	-149.0179	-0.6966	-2.729	-22.7977	37.1284	-151.4926	-28.2182	34.7559	-146.5433
2.128	-24.998	36.0985	-150.4425	-0.7373	-2.6581	-22.5578	37.3798	-152.9457	-27.4383	34.8172	-147.9392
2.144	-24.2945	36.0347	-150.8966	-0.6999	-2.6458	-21.2361	37.689	-153.8246	-27.353	34.3805	-147.9687
2.16	-25.3993	36.6785	-151.7796	-0.4618	-3.0162	-20.492	37.2969	-154.2412	-30.3066	36.0601	-149.3181
2.176	-26.6797	37.7216	-151.3571	-0.5029	-2.8989	-22.9814	38.6373	-153.4528	-30.3781	36.8059	-149.2614
2.192	-24.7013	37.6922	-152.8312	-0.5728	-2.8908	-20.1824	38.8497	-155.8394	-29.2202	36.5348	-148.823
2.208	-25.0482	37.7984	-154.3515	-0.6368	-2.9652	-20.7649	38.562	-157.5692	-29.3316	37.0348	-151.1339
2.224	-25.4979	37.7066	-155.3693	-0.5566	-2.9957	-21.2964	38.3242	-158.0115	-29.6993	37.0891	-152.7271
2.24	-25.1352	38.3341	-156.2501	-0.6753	-2.8707	-21.4728	39.3512	-159.2946	-28.7975	37.3169	-153.2056
2.256	-24.5089	38.8928	-157.1282	-0.6972	-2.996	-20.3316	39.5051	-160.6641	-28.6862	38.2804	-153.5922
2.272	-24.4794	39.2999	-159.0415	-0.5909	3.1333	-20.0364	39.2628	-162.0222	-28.9224	39.3369	-156.0608
2.288	-23.8666	38.4318	-159.4045	-0.6737	-3.0086	-19.4233	39.0264	-162.9829	-28.3099	37.8372	-155.8261
2.304	-25.6897	39.1567	-160.521	-0.7322	-2.9346	-21.6923	39.996	-164.1924	-29.6872	38.3173	-156.8497
2.32	-24.9131	38.8741	-161.4916	-0.7852	-2.9017	-21.3886	39.7361	-165.1184	-28.4375	38.0122	-157.8649
2.336	-25.3031	39.2093	-162.4981	-0.8958	-2.9825	-22.3048	39.6904	-166.2919	-28.3013	38.7281	-158.7042
2.352	-25.0259	39.2414	-163.5723	-0.8287	-3.0563	-21.427	39.5489	-167.5113	-28.6248	38.9339	-159.6334
2.368	-24.6928	38.8199	-164.5472	-0.7123	3.1341	-20.4356	38.7881	-168.2237	-28.9499	38.8517	-160.8708
2.384	-25.5992	38.9308	-164.4093	-0.8061	-3.0612	-21.9706	39.2233	-168.2038	-29.2279	38.6383	-160.6148
2.4	-22.1558	37.5067	-167.0328	-1.2109	-2.959	-21.1784	37.6872	-169.6747	-23.1333	37.3262	-164.3908
2.416	-23.5139	38.8379	-167.7695	-1.1101	3.1261	-21.9233	38.8133	-170.9743	-25.1044	38.8625	-164.5647
2.432	-23.1135	40.9158	-167.6786	-0.9178	2.9552	-20.5527	40.433	-171.0852	-25.6744	41.3986	-164.272
2.448	-24.1587	40.4011	-169.8046	-1.013	3.1382	-21.8316	40.3933	-173.5351	-26.4858	40.409	-166.0741
2.464	-25.6433	41.1496	-170.5595	-1.2385	3.0464	-24.3551	41.0266	-174.3091	-26.9314	41.2725	-166.8099
2.48	-26.5197	40.3467	-171.5962	-1.2958	2.9334	-25.4967	40.1306	-175.3019	-27.5428	40.5628	-167.8906
2.496	-27.4137	41.2422	-171.5815	-1.2079	2.9719	-25.9328	40.9884	-175.5379	-28.8945	41.496	-167.6251
2.512	-26.5147	40.9814	-173.3124	-1.4569	-2.0909	-26.3283	41.3069	-176.5921	-26.7011	40.6559	-170.0326
2.528	-28.4841	41.8154	-173.9153	-1.3937	2.7103	-27.8655	41.5307	-177.7211	-29.1027	42.1	-170.1095
2.544	-28.8405	42.0018	-175.5989	-1.4498	-0.0493	-29.2062	42.0198	-178.6107	-28.4747	41.9838	-172.5871

Ma15

time	pos(x)	pos(y)	pos(z)	el	az	x1	y1	z1	x2	y2	z2
2.56	-28.936	41.6627	-175.881	-1.2778	1.5261	-28.9834	40.6021	-179.4	-28.8886	42.7233	-172.362
2.576	-29.7907	41.2114	-176.9636	-1.2108	0.1716	-30.8813	41.0224	-179.9037	-28.7001	41.4004	-174.0235
2.592	-30.909	42.2576	-178.5615	-1.0301	1.7894	-30.4878	40.3614	-181.7967	-31.3302	44.1538	-175.3262
2.608	-30.8497	43.7207	-179.4806	-0.9893	0.7697	-32.3651	42.2522	-182.6908	-29.3342	45.1892	-176.2703
2.624	-31.8747	43.2785	-179.5884	-1.2194	1.1251	-32.3651	42.2522	-182.6908	-31.3844	44.3048	-176.4861
2.64	-31.692	41.2667	-180.4177	-0.9971	0.4462	-33.2916	40.5016	-183.1617	-30.0924	42.0319	-177.6736
2.656	-32.7216	41.8596	-182.0756	-1.072	0.9966	-33.5924	40.5136	-185.0182	-31.8509	43.2055	-179.1331
2.672	-32.3496	42.233	-182.491	-0.8819	0.4175	-34.1012	41.456	-184.818	-30.5979	43.01	-180.1641
2.688	-32.4448	40.171	-183.2977	-1.0249	0.5692	-33.9698	39.1952	-186.2782	-30.9199	41.1467	-180.3173
2.704	-31.8989	40.4037	-184.5205	-0.9594	0.5416	-33.4329	39.4808	-187.0744	-30.3648	41.3266	-181.9665
2.72	-33.1187	41.2255	-185.247	-0.9124	0.6506	-34.7506	39.9834	-187.8983	-31.4869	42.4675	-182.5957
2.736	-32.8425	41.3445	-186.1778	-1.1043	0.8597	-33.8757	40.1451	-189.3216	-31.8093	42.5439	-183.0339
2.752	-32.8163	41.1682	-187.305	-0.8607	0.5599	-35.0325	39.779	-190.3472	-30.6	42.5573	-184.2628
2.768	-32.2034	41.0867	-188.7627	-0.7681	0.4305	-34.7623	39.9117	-191.4824	-29.6446	42.2617	-186.0429
2.784	-33.4857	41.3909	-188.9999	-0.7752	0.5836	-35.6799	39.9421	-191.576	-31.2916	42.8397	-186.4238
2.8	-34.4526	42.3535	-190.7922	-0.8733	0.6223	-36.5012	40.884	-193.8005	-32.404	43.8231	-187.784
2.816	-34.3132	42.3869	-192.329	-0.8291	0.6445	-36.4843	40.7552	-195.293	-32.1422	44.0185	-189.365
2.832	-33.727	41.7313	-192.999	-0.8122	0.6007	-36.0538	40.1371	-195.9749	-31.4002	43.3256	-190.0231
2.848	-33.1163	41.7256	-194.325	-0.7088	0.558	-35.7442	40.0853	-196.9814	-30.4884	43.3659	-191.6685
2.864	-33.9463	42.0072	-195.2297	-0.819	0.5612	-36.4366	40.4418	-198.3756	-31.456	43.5726	-192.0838
2.88	-33.6276	41.8819	-196.7721	-0.91	0.6585	-35.5189	40.4186	-199.8485	-31.7362	43.3452	-193.6957
2.896	-33.0162	42.7238	-197.922	-0.9035	0.6332	-35.073	41.2141	-201.1605	-30.9595	44.2334	-194.6835
2.912	-33.9733	42.8622	-198.5482	-0.793	0.3753	-37.0141	41.6642	-201.8669	-30.9325	44.0601	-195.2296
2.928	-33.6674	42.8785	-199.9704	-0.8383	0.4877	-36.0728	41.6024	-202.9979	-31.262	44.1545	-196.9429
2.944	-34.0698	43.3349	-200.3157	-0.8858	0.4828	-36.4841	42.0693	-203.6524	-31.6556	44.6005	-196.9789
2.96	-33.7946	43.5054	-202.3255	-1.0171	0.4101	-35.6681	42.691	-205.6297	-31.9211	44.3198	-199.0212
2.976	-32.4341	44.864	-203.1674	-0.8246	-0.0288	-35.6094	44.9553	-206.6036	-29.2588	44.7726	-199.7312
2.992	-33.7173	44.9007	-204.4982	-0.8204	-0.1673	-36.9824	45.452	-208.0499	-30.4523	44.3495	-200.9465
3.008	-31.8353	44.8934	-204.3887	-0.7334	-0.0944	-35.6975	45.259	-207.8845	-27.973	44.5279	-200.8929
3.024	-31.9113	45.3341	-206.0032	-0.7948	-0.1108	-35.7916	45.7657	-209.9813	-28.031	44.9024	-202.0251
3.04	-31.399	45.9666	-207.2471	-0.6478	-0.2555	-36.0628	47.185	-210.8946	-26.7353	44.7482	-203.5995
3.056	-32.1819	46.7944	-207.7146	-0.6958	-0.2799	-36.2232	47.956	-211.226	-28.1407	45.6329	-204.2033
3.072	-33.5212	47.3376	-209.9048	-0.9566	-0.285	-36.221	48.1286	-213.8946	-30.8214	46.5467	-205.915
3.088	-31.5914	47.4428	-211.2301	-1.0501	-0.3556	-33.6421	48.2044	-215.0448	-29.5406	46.6812	-207.4154
3.104	-30.9958	47.8073	-211.0477	-1.2006	-0.2889	-32.3358	48.2056	-214.6503	-29.6557	47.409	-207.4452
3.12	-31.011	47.8813	-213.1159	-0.8392	-0.5561	-33.8663	49.6558	-216.8606	-28.1557	46.1067	-209.3711
3.136	-32.4924	49.1194	-214.1898	-0.8994	-0.388	-35.2707	50.2551	-217.9673	-29.7141	47.9837	-210.4123
3.152	-32.6471	49.8555	-214.7749	-0.7728	-0.4926	-35.5381	51.4072	-217.9745	-29.7561	48.3039	-211.5753
3.168	-32.8461	50.2696	-215.8431	-0.9435	-0.5169	-35.1564	51.583	-219.5085	-30.5359	48.9562	-212.1777
3.184	-32.4446	50.6939	-216.914	-0.784	-0.428	-35.9536	52.2949	-220.7604	-28.9356	49.0929	-213.0675
3.2	-32.3342	50.3307	-217.6117	-0.8551	-0.5566	-34.857	51.9006	-221.0293	-29.8113	48.7609	-214.194
3.216	-32.6488	50.4467	-219.026	-0.953	-0.6175	-34.8166	51.9861	-222.7679	-30.481	48.9073	-215.2841
3.232	-30.9775	51.2755	-219.7644	-1.0833	-0.6587	-32.6041	52.5345	-223.6442	-29.3509	50.0165	-215.8846
3.248	-30.5839	52.013	-220.4044	-1.2264	-0.9858	-31.357	53.1803	-224.3072	-29.8107	50.8457	-216.5016
3.264	-29.85	51.6699	-221.2074	-1.1756	-1.2595	-30.3486	53.2194	-225.1094	-29.3514	50.1203	-217.3053
3.28	-29.6837	51.6822	-222.3433	-0.9714	-1.2513	-30.4979	54.1431	-226.1374	-28.8694	49.2213	-218.5492
3.296	-28.533	51.5754	-223.259	-1.0792	-1.1054	-29.3846	53.2711	-226.8028	-27.6815	49.8796	-219.7153
3.312	-28.6138	52.4722	-224.3535	-1.0974	-1.6314	-28.4909	54.4988	-228.3169	-28.7367	50.4456	-220.3901
3.328	-28.4738	52.7261	-224.9862	-1.1588	-1.5832	-28.4545	54.2885	-228.5614	-28.4931	51.1637	-221.4109
3.344	-27.8941	52.1438	-226.44	-1.0526	-1.4707	-28.0978	54.1732	-230.0172	-27.6903	50.1144	-222.8628
3.36	-28.1406	52.9413	-227.3091	-1.0383	-1.5614	-28.159	54.8881	-230.6128	-28.1223	50.9944	-224.0053
3.376	-26.7258	52.6642	-228.2148	-0.9685	-1.5479	-26.7774	54.9158	-231.4906	-26.6742	50.4127	-224.939
3.392	-26.967	53.4082	-229.1458	-1.176	-1.9571	-26.3894	54.8282	-232.8243	-27.5446	51.9883	-225.4672
3.408	-26.2287	54.1325	-230.1076	-1.0115	-2.1442	-25.1911	55.7392	-233.1631	-27.2663	52.5258	-227.052
3.424	-25.8642	52.9398	-231.1646	-1.2365	-2.0893	-25.2554	54.0068	-234.7016	-26.4731	51.8728	-227.6275
3.44	-25.7699	53.5263	-231.944	-1.1488	-2.0202	-25.0268	55.0669	-235.7538	-26.5131	51.9856	-228.1343
3.456	-25.9091	53.753	-233.1983	-1.1187	-2.1221	-25.0037	55.2255	-236.7574	-26.8145	52.2804	-229.6392
3.472	-24.0355	53.5418	-233.7958	-1.1054	-2.4441	-22.5762	54.7648	-237.5874	-25.4949	52.3187	-230.0041
3.488	-24.8874	53.9433	-235.2052	-1.0157	-2.7674	-22.8494	54.7436	-238.7358	-26.9254	53.143	-231.6747
3.504	-23.4842	53.6017	-236.3729	-0.9233	-2.9031	-20.7458	54.2675	-240.0991	-26.2226	52.9359	-232.6467
3.52	-23.0938	53.2462	-236.831	-0.8244	-2.5575	-20.5247	54.9443	-240.1608	-25.6628	51.5482	-233.5013
3.536	-22.7032	52.6813	-238.3904	-0.8359	-2.9038	-19.6817	53.4137	-241.8302	-25.7248	51.9489	-234.9506
3.552	-22.1987	53.2927	-239.4779	-1.0381	-2.6303	-20.3348	54.3385	-243.1032	-24.0626	52.2468	-235.8527
3.568	-23.0875	54.11	-240.4985	-1.0744	-2.6179	-21.4114	55.0778	-244.0723	-24.7637	53.1421	-236.9247
3.584	-22.6087	53.6548	-241.6974	-0.9581	-2.541	-20.3377	55.2105	-245.6138	-24.8798	52.0991	-237.781
3.6	-22.3548	54.3822	-242.7485	-0.8929	-2.6799	-19.6951	55.7055	-246.4379	-25.0145	53.059	-239.0592

Ma15

time	pos(x)	pos(y)	pos(z)	el	az	x1	y1	z1	x2	y2	z2
3.616	-21.6209	53.6997	-243.5989	-0.83	-2.7772	-18.9458	54.72	-246.7295	-24.2961	52.6794	-240.4683
3.632	-21.4964	52.9554	-244.8677	-0.7851	-2.8837	-18.1196	53.8461	-248.358	-24.8732	52.0647	-241.3773
3.648	-21.6867	53.2765	-246.1634	-0.8349	-2.8743	-18.8225	54.0609	-249.4426	-24.5508	52.4921	-242.8843
3.664	-22.2352	54.2261	-246.9921	-0.718	-2.8978	-18.8946	55.057	-249.9993	-25.5758	53.3952	-243.9848
3.68	-21.4389	53.0521	-247.9685	-0.7556	-2.9125	-18.4478	53.7495	-250.8618	-24.4299	52.3548	-245.0752
3.696	-21.8832	52.5908	-248.3412	-0.7838	-2.9636	-18.704	53.1626	-251.5613	-25.0624	52.0189	-245.1211
3.712	-21.2712	52.1522	-250.4221	-0.899	-2.8305	-18.9415	52.9013	-253.4994	-23.601	51.4031	-247.3447
3.728	-22.0251	52.4188	-251.5573	-0.8987	-2.5957	-19.9754	53.6639	-254.5714	-24.0749	51.1736	-248.5433
3.744	-22.5225	52.5766	-252.784	-1.0331	-2.889	-20.4396	53.1143	-256.3913	-24.6054	52.0389	-249.1767
3.76	-22.7501	51.7196	-253.202	-1.009	-2.8504	-20.7024	52.3334	-256.598	-24.7977	51.1058	-249.806
3.776	-22.2723	51.0305	-254.3279	-1.0056	-2.9583	-20.2501	51.4054	-257.5707	-24.2945	50.6556	-251.0851
3.792	-23.3265	52.643	-255.1349	-1.0568	3.0955	-21.4083	52.5546	-258.5355	-25.2447	52.7314	-251.7343
3.808	-24.5544	51.8414	-256.2967	-1.1322	3.0536	-22.9406	51.699	-259.7504	-26.1683	51.9839	-252.8431
3.824	-24.2851	51.5659	-257.0615	-1.2173	3.1173	-22.8484	51.531	-260.9563	-25.7217	51.6007	-253.1667
3.84	-25.3572	51.2539	-257.6575	-1.3894	2.9703	-24.7611	51.1508	-260.9549	-25.9533	51.3571	-254.36
3.856	-25.5769	51.5771	-258.8467	-1.0398	2.5872	-24.0338	50.6217	-261.9371	-27.1199	52.5325	-255.7563
3.872	-25.58	51.6323	-259.8327	-1.013	2.5292	-24.003	50.5244	-262.9216	-27.157	52.7402	-256.7438
3.888	-23.381	49.538	-262.6098	-0.9767	2.4603	-21.7791	48.2391	-265.6627	-24.983	50.8368	-259.5569
3.904	-24.0945	49.8295	-262.8338	-0.8397	2.5244	-21.8081	48.207	-265.9594	-26.381	51.452	-259.7082
3.92	-23.8463	48.5627	-263.5654	-0.6133	2.5801	-20.1265	46.2229	-266.6587	-27.5661	50.9024	-260.4721
3.936	-27.6366	47.9048	-264.1518	-0.9193	2.7447	-25.413	46.9729	-267.3136	-29.8601	48.8368	-260.9901
3.952	-26.6686	47.1365	-265.906	-0.9114	2.4524	-25.0978	45.8421	-268.532	-28.2395	48.4309	-263.28
3.968	-24.2422	47.0476	-265.9646	-1.169	1.7681	-24.0146	45.9088	-268.6979	-24.4698	48.1864	-263.2313
3.984	-26.2037	47.6977	-267.2669	-1.0775	1.3019	-26.5802	46.3317	-269.9021	-25.8273	49.0636	-264.6317
4	-25.5528	47.615	-268.1832	-0.8921	0.9478	-26.6241	46.1238	-270.4598	-24.4815	49.1062	-265.9066
4.016	-26.1891	47.3706	-269.0126	-0.9699	1.3771	-26.53	45.633	-271.5961	-25.8483	49.1082	-266.4291
4.032	-26.3311	46.1458	-271.1539	-0.8976	0.9675	-27.3879	44.6118	-273.4897	-25.2743	47.6797	-268.818
4.048	-25.763	46.3676	-271.6128	-0.832	1.3859	-26.1329	44.3899	-273.8218	-25.393	48.3454	-269.4039
4.064	-29.0921	46.717	-272.1287	-0.896	1.7965	-28.4774	44.04	-275.5615	-29.7069	49.394	-268.696
4.08	-27.0276	45.8134	-272.6131	-0.7623	1.4724	-27.2652	43.4069	-274.9221	-26.79	48.2199	-270.3041
4.096	-27.2377	44.3844	-274.0694	-0.7176	0.8858	-28.3918	42.9718	-275.6615	-26.0836	45.7971	-272.4773
4.112	-30.4036	46.1045	-274.3432	-0.8371	1.0545	-31.5329	44.1149	-276.8808	-29.2743	48.0941	-271.8057
4.128	-29.5804	46.0419	-275.6141	-0.742	0.7608	-31.3638	44.3441	-277.8715	-27.797	47.7396	-273.3567
4.144	-30.6156	45.6432	-276.9854	-0.7738	1.2836	-31.3718	43.0831	-279.5934	-29.8594	48.2033	-274.3773
4.16	-31.9457	45.4015	-278.2177	-0.8936	1.3729	-32.3529	43.371	-280.7935	-31.5386	47.4321	-275.6418
4.176	-30.4788	44.7562	-279.0524	-0.9052	0.8179	-31.947	43.1894	-281.7872	-29.0107	46.323	-276.3175
4.192	-30.824	44.3168	-279.7487	-0.7274	0.9456	-32.132	42.5047	-281.7382	-29.5161	46.129	-277.7592
4.208	-31.8111	44.0091	-280.7446	-0.7514	1.4197	-32.1609	41.7116	-282.9158	-31.4613	46.3067	-278.5734
4.224	-31.5941	43.6176	-282.4496	-0.759	0.8734	-33.2546	41.6357	-284.9022	-29.9337	45.5994	-279.9969
4.24	-31.9919	43.1235	-282.6171	-0.7023	1.041	-33.2093	41.045	-284.6553	-30.7746	45.202	-280.5789
4.256	-32.121	44.03	-284.2925	-0.7023	0.9572	-33.6013	41.9283	-286.4677	-30.6407	46.1317	-282.1173
4.272	-32.4475	43.7332	-285.1395	-0.6782	1.0354	-33.5456	41.8822	-286.8736	-31.3494	45.5843	-283.4054
4.288	-33.7858	43.9994	-286.6579	-0.5798	1.138	-34.8162	41.769	-288.2669	-32.7553	46.2297	-285.049
4.304	-32.5706	43.1793	-287.3319	-0.6667	0.8444	-34.276	41.2598	-289.3523	-30.8652	45.0989	-285.3114
4.32	-32.4451	42.9894	-288.2984	-0.6427	1.1073	-33.4947	40.8891	-290.0563	-31.3954	45.0897	-286.5405
4.336	-32.0568	42.2908	-289.7172	-0.627	0.9606	-33.5678	40.1299	-291.6277	-30.5457	44.4518	-287.8068
4.352	-33.7566	42.5205	-290.7983	-0.593	0.8094	-35.7621	40.4164	-292.7572	-31.7512	44.6246	-288.8394
4.368	-33.8585	42.644	-291.943	-0.5845	0.875	-35.8966	40.2035	-294.0468	-31.8204	45.0845	-289.8392
4.384	-30.8098	42.9186	-293.5506	-0.5451	0.9417	-32.7403	40.2661	-295.5398	-28.8794	45.5711	-291.5613
4.4	-31.013	42.0764	-293.4378	-0.6301	0.8319	-33.2337	39.6391	-295.8424	-28.7923	44.5137	-291.0332
4.416	-33.6567	42.21	-294.7398	-0.5589	0.9666	-35.4091	39.6715	-296.669	-31.9043	44.7485	-292.8106
4.432	-32.4396	41.7816	-296.3814	-0.5724	0.8263	-34.6906	39.3383	-298.5222	-30.1886	44.2249	-294.2406
4.448	-31.7658	42.3597	-298.2579	-0.7851	0.6155	-33.8977	40.8521	-300.8673	-29.6339	43.8674	-295.6486
4.464	-30.5417	41.7225	-298.9492	-0.6601	0.4845	-33.4504	40.1916	-301.5009	-27.633	43.2534	-296.3974
4.48	-31.3414	41.7655	-299.955	-0.9116	0.4218	-33.7952	40.6644	-303.426	-28.8877	42.8666	-296.4839
4.496	-30.1978	41.9842	-300.6218	-0.7854	0.4108	-33.3258	40.6216	-304.0337	-27.0697	43.3468	-297.21
4.512	-33.2254	42.7559	-301.6963	-0.9365	0.5464	-35.4613	41.3962	-305.2532	-30.9895	44.1155	-298.1394
4.528	-29.5484	43.1596	-302.3221	-0.7946	0.1869	-33.1544	42.4776	-306.06	-25.9424	43.8416	-298.5842
4.544	-30.5919	42.7993	-303.3825	-1.217	0.4045	-31.7254	42.314	-306.7204	-29.4584	43.2845	-300.0445
4.56	-31.2885	43.456	-304.3471	-0.8923	0.0136	-34.2856	43.4151	-308.0648	-28.2914	43.4968	-300.6294
4.576	-31.546	44.7752	-305.448	-1.1358	-0.1827	-33.3338	45.1055	-309.3603	-29.7582	44.4449	-301.5358
4.592	-35.873	45.4619	-307.2165	-1.3826	0.3208	-36.657	45.2015	-311.5529	-35.0891	45.7224	-302.88
4.608	-33.6968	44.1826	-308.3444	-1.2386	0.1487	-35.1771	43.9608	-312.6828	-32.2165	44.4045	-304.006
4.624	-33.5791	44.9601	-309.7042	-1.1067	-0.1656	-35.3717	45.2596	-313.335	-31.7864	44.6605	-306.0733
4.64	-33.7056	44.703	-310.3905	-1.1933	0.5541	-35.0774	43.8542	-314.4594	-32.3338	45.5517	-306.3216
4.656	-33.2961	44.2062	-311.4133	-1.0899	0.2405	-35.466	43.6741	-315.6953	-31.1263	44.7383	-307.1314

Ma15											
time	pos(x)	pos(y)	pos(z)	el	az	x1	y1	z1	x2	y2	z2
4.672	-33.5046	44.3202	-311.9891	-1.1869	0.8428	-34.5248	43.1755	-315.7851	-32.4844	45.4648	-308.1931

Rockan Data Table

Rockan1	v1= 2.341										
time	pos(x)	pos(y)	pos(z)	el	az	x1	y1	z1	x2	y2	z2
0	0	0	0	-1.0909	0.4347	-3.1778	-1.4754	-6.7322	3.1778	1.4754	6.7322
0.016	-1.5213	-0.0212	-3.4633	-0.8896	0.1011	-6.0533	-0.481	-9.0828	3.0108	0.4386	2.1562
0.032	-1.7519	-0.417	-7.4916	-0.81	0.2263	-6.9983	-1.6252	-13.1475	3.4945	0.7911	-1.8358
0.048	-2.6044	0.1186	-9.3175	-0.533	0.1463	-8.8762	-0.8054	-13.0579	3.6674	1.0426	-5.5771
0.064	-3.6215	-1.4616	-15.1765	-0.0921	0.2488	-9.8771	-3.0511	-15.7726	2.634	0.1279	-14.5804
0.08	-3.6834	-1.7827	-18.187	-0.2723	0.6157	-8.2812	-5.0351	-19.7595	0.9144	1.4697	-16.6144
0.096	-3.9242	-0.6185	-19.5502	-0.1968	0.7226	-7.5435	-3.8098	-20.5124	-0.3048	2.5727	-18.5879
0.112	-4.6364	-1.2403	-21.6567	0.5977	0.6737	-6.9396	-3.0789	-19.6506	-2.3331	0.5984	-23.6629
0.128	-4.3339	-1.0147	-22.1719	0.9957	0.49	-6.9372	-2.4031	-17.6204	-1.7306	0.3737	-26.7235
0.144	-3.1408	-0.2103	-23.2864	1.1896	0.4863	-4.7739	-1.0735	-18.6776	-1.5077	0.6529	-27.8952
0.16	-3.2817	-0.4748	-24.4951	1.2512	0.5543	-4.663	-1.33	-19.5865	-1.9004	0.3804	-29.4036
0.176	-3.7457	-0.2614	-26.8867	1.263	0.6821	-4.9605	-1.248	-21.9646	-2.5309	0.7252	-31.8088
0.192	-4.2005	-0.7538	-28.7352	1.3913	0.0348	-5.3969	-0.7954	-22.1391	-3.0042	-0.7121	-35.3314
0.208	-3.9435	-0.4356	-29.6526	1.455	0.9374	-4.3629	-1.0066	-23.564	-3.5242	0.1355	-35.7413
0.224	-4.1369	0.1579	-30.2958	1.4091	-0.2091	-5.2384	0.3916	-23.3909	-3.0353	-0.0759	-37.2008
0.24	-3.7495	0.026	-31.4908	1.4458	-0.5643	-4.5482	0.5315	-23.9682	-2.9509	-0.4795	-39.0134
0.256	-3.798	0.3704	-32.5785	1.4722	-1.0921	-4.1724	1.0918	-24.3626	-3.4237	-0.3509	-40.7943
0.272	-4.5104	0.7902	-33.8725	1.4597	-1.1782	-4.8662	1.6495	-25.5342	-4.1545	-0.069	-42.2107
0.288	-4.2266	-0.5842	-37.4886	1.5447	-0.9605	-4.334	-0.4306	-30.3133	-4.1192	-0.7378	-44.6638
0.304	-4.3668	-0.9652	-40.4257	1.4846	-0.8079	-4.8206	-0.4904	-32.8248	-3.913	-1.4399	-48.0265
0.32	-4.1352	-0.8931	-42.1855	1.5355	-0.972	-4.2825	-0.6773	-34.7903	-3.9879	-1.109	-49.5808
0.336	-3.5598	-1.1408	-44.3497	1.504	-1.768	-3.4625	-0.6541	-36.9345	-3.6571	-1.6276	-51.765
0.352	-3.5342	-1.1692	-47.2226	1.4282	-1.2148	-3.9059	-0.1694	-39.7953	-3.1624	-2.1689	-54.6499
0.368	-3.3777	-0.6251	-48.2336	1.4032	-1.2459	-3.8166	0.678	-40.1061	-2.9388	-1.9282	-56.3611
0.384	-3.8575	-0.8137	-50.1982	1.4455	-2.0339	-3.4471	0.0082	-42.9066	-4.2679	-1.6355	-57.4898
0.4	-3.6475	-0.7767	-52.8022	1.4117	-1.7329	-3.4411	0.4852	-44.835	-3.8539	-2.0387	-60.7693
0.416	-3.2481	-1.3744	-55.1803	1.411	-1.9798	-2.7806	-0.2959	-47.8853	-3.7156	-2.453	-62.4754
0.432	-3.4403	-1.5723	-57.1153	1.3476	-1.81	-3.0031	0.2203	-48.987	-3.8776	-3.3649	-65.2437
0.448	-3.6626	-1.4236	-58.9339	1.3382	-1.9695	-2.9187	0.3424	-50.8461	-4.4065	-3.1896	-67.0217
0.464	-3.3577	-1.9399	-61.5024	1.3258	-2.114	-2.3449	-0.2624	-53.6659	-4.3705	-3.6174	-69.3388
0.48	-3.4172	-2.1143	-63.8959	1.292	-2.0446	-2.4411	-0.2108	-56.4216	-4.3932	-4.0178	-71.3702
0.496	-3.4587	-2.1565	-65.9425	1.2282	-2.1978	-1.7643	0.1818	-57.8458	-5.153	-4.4948	-74.0392
0.512	-3.5062	-2.6519	-68.6342	1.2167	-2.2186	-1.7917	-0.3866	-60.95	-5.2206	-4.9172	-76.3185
0.528	-3.5281	-2.7994	-70.6906	1.1735	-2.2646	-1.6503	-0.5416	-63.6922	-5.4059	-5.0572	-77.689
0.544	-3.7263	-3.5113	-73.3905	1.12	-2.1853	-1.6683	-0.595	-66.0161	-5.7844	-6.4276	-80.765
0.56	-4.5268	-3.3716	-75.1217	1.0388	-2.5049	-1.5071	-1.1388	-68.7409	-7.5466	-5.6043	-81.5025
0.576	-4.0862	-4.0197	-77.3362	1.0281	-2.3687	-1.1906	-1.1956	-70.6299	-6.9819	-6.8438	-84.0425
0.592	-4.5922	-3.5721	-79.572	1.0056	-2.5	-1.4041	-1.1903	-73.2971	-7.7803	-5.9539	-85.8468
0.608	-4.7884	-4.0551	-82.0393	0.9517	-2.5132	-1.361	-1.5643	-76.0926	-8.2157	-6.5458	-87.9859
0.624	-4.6145	-4.4555	-84.5696	0.8996	-2.5406	-0.7112	-1.7795	-78.6103	-8.5178	-7.1314	-90.529
0.64	-5.1355	-4.7063	-86.3251	0.8652	-2.4912	-1.1952	-1.7084	-80.5132	-9.0757	-7.7042	-92.137
0.656	-5.2134	-4.7716	-87.9308	0.8622	-2.4516	-1.3815	-1.6094	-82.1341	-9.0452	-7.9338	-93.7276
0.672	-5.2769	-5.7056	-90.7561	0.7984	-2.4465	-1.052	-2.1823	-85.11	-9.5018	-9.2289	-96.4021
0.688	-5.4289	-6.3009	-93.0159	0.6939	-2.4591	-0.9145	-2.6314	-88.1764	-9.9433	-9.9703	-97.8554
0.704	-5.1828	-6.1956	-94.4562	0.6428	-2.5283	-0.3852	-2.8191	-90.0626	-9.9805	-9.5721	-98.8497
0.72	-5.6923	-7.0454	-96.4758	0.5785	-2.5101	-0.5738	-3.3013	-92.3346	-10.8109	-10.7895	-100.6171
0.736	-5.5007	-7.3769	-98.3468	0.5547	-2.5137	-0.5187	-3.7605	-94.5327	-10.4827	-10.9934	-102.1609
0.752	-5.4559	-7.5256	-99.7408	0.4476	-2.5493	0.0368	-3.8293	-96.5623	-10.9487	-11.2219	-102.9192
0.768	-5.4684	-8.5166	-102.0428	0.4085	-2.5837	0.2026	-4.978	-99.1493	-11.1395	-12.0551	-104.9362
0.784	-5.8331	-8.8415	-103.3637	0.339	-2.6082	-0.2886	-5.5676	-101.0935	-11.3776	-12.1155	-105.634
0.8	-5.9118	-9.4808	-104.844	0.3064	-2.6343	0.0275	-6.1795	-102.694	-11.8511	-12.7822	-106.9941
0.816	-5.4834	-10.0144	-106.1955	0.2394	-2.6688	0.3765	-7.0173	-104.5887	-11.3434	-13.0115	-107.8023
0.832	-5.9488	-10.5212	-107.7477	0.1601	-2.7585	0.3205	-7.9946	-106.6559	-12.2182	-13.0478	-108.8395
0.848	-5.842	-11.0395	-109.2615	0.1173	-2.894	0.6137	-9.4074	-108.4765	-12.2977	-12.6717	-110.0464
0.864	-6.678	-11.0558	-110.1315	0.0852	-2.9285	0.0324	-9.6036	-109.5455	-13.3884	-12.5079	-110.7176
0.88	-6.447	-11.0704	-111.0218	0.1214	-2.959	0.2678	-9.8307	-110.1891	-13.1617	-12.3101	-111.8545

Rock1 time	pos(x)	pos(y)	pos(z)	el	az	x1	y1	z1	x2	y2	z2
0.896	-6.1755	-11.922	-112.7567	-0.0241	3.0997	0.3689	-12.196	-112.9148	-12.7198	-11.648	-112.5986
0.912	-5.9651	-12.5257	-113.6903	0.0477	3.0127	0.5286	-13.3671	-113.378	-12.4589	-11.6843	-114.0026
0.928	-6.0022	-13.5801	-115.4455	0.0767	3.0972	0.4592	-13.8669	-114.9483	-12.4637	-13.2933	-115.9428
0.944	-6.1228	-14.0824	-116.0267	0.1342	2.9924	0.4338	-15.0681	-115.1314	-12.6793	-13.0967	-116.922
0.96	-6.4236	-14.656	-116.8472	0.1541	3.0092	-0.9065	-15.3905	-115.9825	-11.9406	-13.9216	-117.7119
0.976	-6.4841	-14.8022	-116.8185	0.1257	2.9038	-0.3998	-16.2772	-116.0275	-12.5683	-13.3272	-117.6095
0.992	-6.3109	-15.1897	-117.8553	0.2276	2.9198	-0.3587	-16.5318	-116.4421	-12.2632	-13.8475	-119.2684
1.008	-6.5001	-15.2552	-118.1959	0.161	2.7233	-0.7767	-17.7995	-117.1787	-12.2235	-12.7108	-119.2132
1.024	-6.315	-15.5718	-119.5588	0.3157	2.5792	-1.3836	-18.6802	-117.6549	-11.2463	-12.4634	-121.4628
1.04	-6.3139	-16.3069	-120.3411	0.3786	2.5179	-1.5408	-19.7414	-118.0017	-11.0871	-12.8724	-122.6805
1.056	-6.4749	-17.3163	-120.7869	0.4726	2.5324	-1.8744	-20.5258	-117.9194	-11.0755	-14.1068	-123.6545
1.072	-5.8941	-17.7298	-121.6826	0.594	2.6237	-1.5638	-20.1972	-118.3165	-10.2244	-15.2625	-125.0486
1.088	-6.4183	-17.7805	-122.1757	0.4971	2.4393	-2.2306	-21.3239	-119.1996	-10.606	-14.2371	-125.1518
1.104	-6.8771	-17.9415	-122.6942	0.4498	2.3819	-2.5997	-22.0047	-119.8461	-11.1546	-13.8783	-125.5424
1.12	-6.7184	-18.4201	-123.7173	0.5173	2.419	-2.5896	-22.0605	-120.5852	-10.8471	-14.7797	-126.8495
1.136	-6.9681	-18.7645	-124.0384	0.6651	2.5378	-3.1378	-21.4065	-120.3891	-10.7983	-16.1225	-127.6877
1.152	-6.9849	-19.068	-124.2413	0.7557	2.5063	-3.4481	-21.6758	-120.1005	-10.5218	-16.4602	-128.3821
1.168	-6.7617	-19.5369	-126.1889	0.6797	2.3759	-3.5122	-22.6605	-122.546	-10.0112	-16.4132	-129.8319
1.184	-7.1015	-19.4999	-126.3705	0.6095	2.3689	-3.7491	-22.7683	-123.1016	-10.4539	-16.2315	-129.6395
1.2	-7.1828	-19.1819	-127.276	0.6823	2.1976	-4.6846	-22.6316	-123.8151	-9.681	-15.7322	-130.7368
1.216	-7.3107	-19.5746	-128.3429	0.9278	2.3741	-4.8683	-21.9312	-123.8131	-9.753	-17.2179	-132.8726
1.232	-7.8092	-20.6021	-128.196	0.7623	2.1746	-5.1743	-24.4225	-123.7647	-10.4441	-16.7818	-132.6274
1.248	-7.4398	-20.0033	-128.8844	0.8481	2.2453	-5.0747	-22.9609	-124.5905	-9.8049	-17.0457	-133.1784
1.264	-7.7402	-20.1382	-130.1644	0.8744	2.1937	-5.5352	-23.2081	-125.6444	-9.9452	-17.0683	-134.6843
1.28	-8.1677	-20.723	-130.4068	0.7732	2.1991	-5.6315	-24.2139	-126.1959	-10.704	-17.2321	-134.6177
1.296	-7.9166	-20.92	-131.3259	0.7323	2.1119	-5.605	-24.7665	-127.291	-10.2282	-17.0735	-135.3608
1.312	-8.1937	-20.2016	-132.048	0.643	2.0671	-5.474	-25.2245	-127.7685	-10.9134	-15.1787	-136.3276
1.328	-8.1645	-21.4348	-133.8848	0.8603	2.0739	-6.1646	-25.0687	-129.0638	-10.1645	-17.8009	-138.7058
1.344	-8.2085	-21.3502	-134.4428	0.8751	1.9714	-6.5745	-25.2081	-129.4249	-9.8424	-17.4924	-139.4606
1.36	-8.4959	-21.2934	-135.472	0.8099	2.0936	-6.3052	-25.0949	-130.8638	-10.6865	-17.4919	-140.0802
1.376	-8.758	-21.311	-136.4477	0.6934	2.0879	-6.305	-25.6244	-132.3236	-11.2109	-16.9976	-140.5718
1.392	-8.4054	-21.2452	-137.6305	0.6747	2.0239	-6.1433	-25.891	-133.4967	-10.6675	-16.5994	-141.17642
1.408	-8.6133	-21.1541	-138.5449	0.6426	2.0419	-6.2378	-25.818	-134.6264	-10.9888	-16.4903	-142.4634
1.424	-8.4692	-20.9569	-139.4281	0.6392	1.9879	-6.3702	-25.6937	-135.5768	-10.5681	-16.2201	-143.2794
1.44	-8.506	-20.9353	-140.1989	0.6115	2.0183	-6.0712	-26.0085	-136.2532	-10.9408	-15.8622	-144.1447
1.456	-8.7724	-20.7957	-141.5964	0.5727	1.9946	-6.4228	-26.0041	-137.9124	-11.1221	-15.5873	-145.2805
1.472	-8.3898	-20.5692	-142.3467	0.5223	1.9963	-5.8799	-26.1067	-138.8473	-10.8996	-15.0317	-145.846
1.488	-8.7852	-20.4721	-143.1323	0.5719	2.0064	-6.4609	-25.466	-139.5868	-11.1095	-15.4783	-146.6779
1.504	-8.9909	-20.057	-144.3874	0.5128	1.9496	-6.7756	-25.6222	-141.0149	-11.2061	-14.4919	-147.7599
1.52	-8.8836	-19.2335	-144.8972	0.4326	1.9043	-6.7953	-25.2618	-141.9508	-10.972	-13.2051	-147.8436
1.536	-9.0866	-18.3301	-145.6037	0.3861	1.9553	-6.5851	-24.5121	-142.8925	-11.588	-12.1481	-148.3149
1.552	-9.341	-17.8219	-146.6324	0.3536	2.0199	-6.198	-24.3435	-143.9601	-12.484	-11.3002	-149.3046
1.568	-9.0322	-17.7509	-147.5815	0.2864	1.9496	-6.2667	-24.6981	-145.3793	-11.7977	-10.8038	-149.7838
1.584	-9.1001	-17.6147	-148.355	0.2911	1.9198	-6.52	-24.7059	-146.0938	-11.6803	-10.5235	-150.6163
1.6	-8.8333	-15.5844	-149.0973	0.3463	1.9559	-6.3424	-21.7287	-146.7049	-11.3242	-9.4401	-151.4896
1.616	-9.8128	-14.4509	-149.9968	0.3561	2.0052	-7.0165	-20.4774	-147.5256	-12.6091	-8.4244	-152.4679
1.632	-9.1752	-14.5117	-150.0845	0.3418	1.9971	-6.6219	-20.1334	-147.8877	-11.7284	-8.89	-152.2814
1.648	-9.8839	-12.4437	-150.7174	0.3317	2.1404	-6.8527	-17.1768	-148.7818	-12.9151	-7.7106	-152.6531
1.664	-9.4039	-12.6439	-150.9865	0.3395	2.1945	-6.1094	-17.2231	-148.9944	-12.6984	-8.0648	-152.9786
1.68	-10.5058	-11.6298	-151.7655	0.2999	2.3091	-5.7124	-16.8969	-149.563	-15.2992	-6.3626	-153.9679
1.696	-9.4996	-10.9476	-152.1075	0.1291	2.3353	-2.732	-18.004	-150.8381	-16.2672	-3.8911	-153.3769
1.712	-9.9605	-10.4505	-152.6403	0.1296	2.3496	-3.4832	-17.0131	-151.4384	-16.4378	-3.8878	-153.8423
1.728	-10.1884	-10.1026	-152.8818	0.1293	2.306	-3.8996	-17.0564	-151.6631	-16.4772	-3.1487	-154.1005
1.744	-10.9245	-8.7394	-153.2103	0.1007	2.2921	-4.7426	-15.7696	-152.2648	-17.1064	-1.7092	-154.1558
1.76	-12.3344	-7.6521	-153.1012	0.0591	2.3525	-5.9096	-14.1243	-152.5617	-18.7592	-1.1799	-153.6406
1.776	-12.6015	-7.166	-153.3353	-0.082	2.2898	-7.2211	-13.3128	-154.007	-17.9819	-1.0192	-152.6637
1.792	-12.6716	-7.3309	-154.0214	-0.0655	2.2819	-7.2057	-13.6753	-154.5703	-18.1374	-0.9866	-153.4725
1.808	-13.2301	-6.6821	-154.3067	-0.0677	2.3567	-7.8319	-12.0753	-154.8239	-18.6284	-1.289	-153.7896
1.824	-14.2933	-5.7209	-154.4667	-0.0681	2.2966	-9.1447	-11.5234	-154.9959	-19.4419	0.0817	-153.9374
1.84	-14.7271	-4.9941	-155.0315	-0.122	2.2937	-9.1926	-11.2679	-156.0576	-20.2616	1.2797	-154.0054
1.856	-15.3105	-3.7703	-155.2486	-0.1257	2.3167	-10.2455	-9.252	-156.1915	-20.3754	1.7113	-154.3056
1.872	-16.1937	-3.3539	-155.4958	-0.1756	2.3342	-11.1106	-8.6705	-156.8012	-21.2813	1.9626	-154.1904
1.888	-16.7869	-2.403	-155.5235	-0.2046	2.3312	-11.9341	-7.5046	-156.9849	-21.6398	2.6985	-154.0621
1.904	-16.9394	-3.4339	-156.2878	-0.3105	2.3774	-11.9693	-8.1973	-158.497	-21.9094	1.3295	-154.0785
1.92	-17.5828	-1.9889	-156.0843	-0.36	2.3914	-13.3106	-5.9703	-158.2823	-21.855	1.9924	-153.8862
1.936	-18.7645	-0.955	-156.093	-0.3628	2.2598	-14.8846	-5.6652	-158.4097	-22.6443	3.7552	-153.7763

Rock1	time	pos(x)	pos(y)	pos(z)	el	az	x1	y1	z1	x2	y2	z2
	1.952	-19.0841	-0.4624	-156.2781	-0.3997	2.2302	-15.0537	-5.6619	-159.0573	-23.1146	4.7371	-153.4989
	1.968	-19.5448	-0.9623	-156.7548	-0.3792	2.214	-15.196	-6.7644	-159.644	-23.8937	4.8399	-153.8655
	1.984	-19.8821	-0.274	-156.936	-0.3845	2.235	-15.3145	-6.1081	-159.9343	-24.4498	5.5601	-153.9376
	2	-20.9775	1.4605	-156.2549	-0.4562	2.1283	-16.8569	-5.1486	-160.0772	-25.0982	8.0696	-152.4327
	2.016	-21.131	0.2602	-156.8483	-0.463	2.2028	-17.2033	-5.104	-160.1671	-25.0588	5.6244	-153.5294
	2.032	-21.3932	1.3944	-157.2475	-0.4887	2.1801	-17.594	-4.0495	-160.7774	-25.1925	6.8383	-153.7177
	2.048	-21.4846	1.9035	-157.1318	-0.5138	2.1787	-17.2338	-4.2053	-161.332	-25.7353	8.0123	-152.9316
	2.064	-21.7194	1.8471	-156.8613	-0.5446	2.1467	-17.9829	-3.907	-161.0167	-25.4559	7.6012	-152.7059
	2.08	-21.8239	1.8014	-157.7565	-0.5676	2.1432	-17.912	-4.2699	-162.3614	-25.7357	7.8727	-153.1516
	2.096	-22.3211	2.2843	-158.1094	-0.5782	2.1625	-18.1657	-3.8989	-162.9711	-26.4764	8.4676	-153.2477
	2.112	-23.5246	2.4491	-158.7689	-0.628	2.1959	-19.4076	-3.256	-163.8774	-27.6417	8.1542	-153.6604
	2.128	-23.6716	3.0529	-159.074	-0.6341	2.1563	-19.911	-2.6185	-164.0788	-27.4323	8.7244	-154.0692
	2.144	-24.1904	3.1859	-159.146	-0.6349	2.2154	-19.9477	-2.4579	-164.3475	-28.4331	8.8298	-153.9444
	2.16	-24.4385	4.1033	-159.2201	-0.631	2.1607	-20.4338	-1.8797	-164.4803	-28.4433	10.0863	-153.9599
	2.176	-24.3486	3.7848	-159.3407	-0.6748	2.182	-20.505	-1.7006	-164.6995	-28.1922	9.2702	-153.982
	2.192	-24.8834	4.1825	-159.9791	-0.6984	2.1069	-21.692	-1.1892	-165.2253	-28.0749	9.5542	-154.733
	2.208	-24.3133	4.5816	-160.2061	-0.6538	2.238	-19.9909	-0.9054	-165.5583	-28.6358	10.0686	-154.854
	2.224	-25.4472	5.1119	-160.4907	-0.6827	2.151	-21.9424	-0.2352	-165.6888	-28.9519	10.459	-155.2925
	2.24	-25.4286	5.0317	-161.0897	-0.6804	2.1727	-21.7208	-0.3656	-166.3888	-29.1363	10.4291	-155.7906
	2.256	-25.3322	4.9774	-161.4265	-0.7028	2.1882	-21.5639	-0.3296	-166.9401	-29.1004	10.2844	-155.9129
	2.272	-25.7095	5.3329	-162.231	-0.7211	2.2213	-21.8973	0.3238	-167.7641	-29.5217	10.342	-156.6978
	2.288	-25.8011	5.4462	-162.3391	-0.7743	2.1493	-22.4586	0.3279	-168.3181	-29.1436	10.5646	-156.3602
	2.304	-25.5715	5.3235	-162.8519	-0.7944	2.1254	-22.4369	0.2635	-168.912	-28.706	10.3834	-156.7918
	2.32	-25.8553	5.5452	-163.4057	-0.7636	2.1465	-22.4616	0.316	-169.3736	-29.2489	10.7743	-157.4378
	2.336	-26.2024	6.1374	-164.0271	-0.7986	2.135	-23.059	1.1699	-170.0632	-29.3458	11.1048	-157.9911
	2.352	-26.2146	6.4765	-164.5895	-0.8329	2.173	-23.0818	1.9187	-170.6719	-29.3473	11.0343	-158.5071
	2.368	-26.1488	6.5903	-165.3029	-0.8316	2.1392	-23.0307	1.7082	-171.6574	-29.2669	11.4724	-158.9483
	2.384	-26.2798	6.7295	-165.8973	-0.8902	2.2088	-23.3109	2.7254	-172.0536	-29.2488	10.7337	-159.741
	2.4	-25.9724	6.5946	-166.5333	-0.81	2.1385	-22.8624	1.7182	-172.6088	-29.0823	11.4711	-160.4577
	2.416	-26.1876	6.8347	-167.377	-0.7831	2.2115	-22.2893	1.6065	-173.8682	-30.0859	12.0629	-160.8858
	2.432	-25.8949	6.8996	-167.7805	-0.8005	2.1566	-22.5325	1.8317	-174.0487	-29.2573	11.9674	-161.5124
	2.448	-26.1126	7.1558	-168.4385	-0.7408	2.1929	-22.0954	1.5542	-174.7432	-30.1298	12.7574	-162.1337
	2.464	-25.9744	7.2652	-169.3369	-0.6977	2.2156	-21.7527	1.6514	-175.2262	-30.1961	12.879	-163.4477
	2.48	-26.2293	7.171	-169.8732	-0.6902	2.1646	-22.1922	1.1905	-175.8314	-30.2665	13.1515	-163.915
	2.496	-26.2559	6.5284	-171.0226	-0.7006	2.1965	-22.0798	0.7488	-177.0353	-30.432	12.308	-165.0098
	2.512	-25.8006	7.2253	-171.567	-0.6214	2.1859	-21.4242	1.0309	-176.9972	-30.177	13.4196	-166.1368
	2.528	-25.0989	6.7128	-172.4366	-0.598	2.1914	-20.5232	0.3115	-177.7966	-29.6747	13.1141	-167.0766
	2.544	-25.2192	6.7605	-173.6856	-0.6033	2.2182	-20.6146	0.6707	-178.9459	-29.8238	12.8502	-168.4253
	2.56	-24.6259	7.8076	-174.0603	-0.5722	2.1852	-20.0301	1.2929	-179.1953	-29.2217	14.3223	-168.9253
	2.576	-25.062	7.5757	-175.2113	-0.4959	2.2496	-19.2841	0.4138	-180.1891	-30.8399	14.7376	-170.2335
	2.592	-24.2613	7.1623	-175.633	-0.5027	2.2087	-18.777	-0.2364	-180.6964	-29.7455	14.5611	-170.5697
	2.608	-24.7532	8.3129	-177.3247	-0.4739	2.2246	-19.275	1.1637	-181.9443	-30.2313	15.462	-172.7051
	2.624	-24.8641	9.0512	-177.9525	-0.4594	2.3626	-19.9498	4.1998	-181.3684	-29.7784	13.9027	-174.5366
	2.64	-24.6928	9.0532	-178.6506	-0.4408	2.2896	-19.7858	3.4448	-182.1665	-29.5998	14.6617	-175.1346
	2.656	-24.0511	8.7042	-178.7044	-0.2567	2.3278	-18.5289	2.8592	-180.8151	-29.5733	14.5493	-176.5936
	2.672	-24.0459	8.5298	-179.6959	-0.2215	2.2493	-18.4491	1.5871	-181.7038	-29.6428	15.4725	-177.6879
	2.688	-24.567	9.1405	-180.9508	-0.1484	2.2676	-19.2761	2.8176	-182.1837	-29.8578	15.4635	-179.7179
	2.704	-24.1562	9.4656	-181.5721	-0.1071	2.2198	-19.0806	2.7753	-182.4746	-29.2318	16.156	-180.6696
	2.72	-24.1671	9.0188	-182.2908	-0.0564	2.2487	-18.8047	2.3587	-182.7732	-29.5295	15.6789	-181.8083
	2.736	-24.4572	9.3548	-183.0458	-0.0482	2.255	-19.0834	2.7658	-183.4556	-29.8309	15.9438	-182.6359
	2.752	-24.3067	9.6133	-183.9685	-0.0081	2.2158	-19.32	2.9846	-184.0357	-29.2934	16.2419	-183.9014
	2.768	-23.6909	9.1149	-184.7094	-0.0483	2.2561	-18.5312	2.8028	-185.1036	-28.8506	15.4271	-184.3152
	2.784	-23.7673	9.4122	-185.1819	0.0099	2.2616	-18.6065	3.1692	-185.1014	-28.9281	15.6552	-185.2625
	2.8	-23.5448	9.5935	-187.4231	0.1861	2.312	-17.4629	2.9484	-185.7266	-29.6267	16.2387	-189.1196
	2.816	-21.9742	8.9351	-187.222	0.1989	2.3429	-14.0812	0.8291	-184.9416	-29.8673	17.041	-189.5023
	2.832	-21.4062	8.401	-187.4794	0.1862	2.3238	-14.0362	0.5379	-185.449	-28.7761	16.264	-189.5098
	2.848	-20.6577	8.1439	-188.5132	0.2515	2.3414	-12.4329	-0.3273	-185.48	-28.8826	16.6151	-191.5465
	2.864	-20.9867	8.3879	-189.0823	0.2182	2.2859	-14.0136	0.3588	-186.7248	-27.9598	16.417	-191.4399
	2.88	-22.1163	8.5996	-189.7467	0.2317	2.4041	-14.5391	1.7152	-187.3312	-29.6936	15.4839	-192.1621
	2.896	-21.6016	8.974	-191.0395	0.2535	2.392	-13.3662	1.3082	-188.1242	-29.8369	16.6398	-193.9547
	2.912	-21.4251	8.651	-191.8762	0.2203	2.3817	-13.3142	0.9441	-189.3709	-29.536	16.3579	-194.3815
	2.928	-21.9364	8.9034	-192.8693	0.2425	2.3676	-13.4446	0.6036	-189.9321	-30.4281	17.2033	-195.8064
	2.944	-22.4193	9.6257	-193.778	0.2386	2.3929	-14.4542	2.2242	-191.1333	-30.3843	17.0272	-196.4228
	2.96	-22.0074	9.4332	-194.8084	0.2783	2.4369	-13.5209	2.2169	-191.625	-30.494	16.6494	-197.9918
	2.976	-22.2004	10.0788	-195.5618	0.3127	2.4006	-14.3906	2.9338	-192.1395	-30.0101	17.2238	-198.984
	2.992	-22.4149	10	-196.7526	0.2568	2.4256	-14.1839	2.8386	-193.8881	-30.6459	17.1614	-199.6172

Rock1 time	pos(x)	pos(y)	pos(z)	el	az	x1	y1	z1	x2	y2	z2
3.008	-22.2183	10.5434	-196.9924	0.2575	2.4138	-13.4124	2.6985	-193.8869	-31.0243	18.3883	-200.0979
3.024	-21.1801	10.5147	-198.0186	0.2821	2.4011	-12.6716	2.7379	-194.6783	-29.6885	18.2915	-201.359
3.04	-22.436	11.9243	-199.2303	0.267	2.4419	-14.1516	4.9514	-196.2689	-30.7204	18.8973	-202.1917
3.056	-25.3536	12.1428	-201.0144	0.3142	2.2467	-20.4361	6.0106	-198.4604	-30.2711	18.275	-203.5685
3.072	-22.7111	11.8585	-202.389	0.305	2.1735	-18.956	6.4016	-200.3036	-26.4662	17.3154	-204.4744
3.088	-24.796	13.5257	-202.7317	0.2313	2.2137	-21.0174	8.4815	-201.2474	-28.5746	18.5698	-204.2161
3.104	-22.8833	12.4287	-202.6123	0.0998	1.9587	-19.0693	3.0951	-201.603	-26.6972	21.7622	-203.6217
3.12	-24.7133	13.249	-203.2909	0.1713	1.9073	-21.904	5.2187	-201.8188	-27.5226	21.2793	-204.763
3.136	-24.9799	12.1268	-203.6802	0.1354	1.9107	-21.7705	3.051	-202.3691	-28.1894	21.2026	-204.9913
3.152	-25.7556	12.4288	-204.8523	0.1452	1.9117	-22.6962	3.8045	-203.5138	-28.8149	21.053	-206.1908
3.168	-25.6846	13.7876	-205.867	0.131	1.9036	-22.519	4.6305	-204.5905	-28.8501	22.9448	-207.1435
3.184	-26.3253	13.7706	-206.4706	0.1106	1.9075	-23.033	4.3641	-205.3641	-29.6176	23.1771	-207.577
3.2	-26.6051	13.3784	-206.6215	0.0687	1.8499	-24.0079	4.3177	-205.9731	-29.2022	22.439	-207.2699
3.216	-26.1048	12.9824	-207.4618	0.0599	1.8855	-22.9999	3.4445	-206.8603	-29.2098	22.5202	-206.6033
3.232	-26.3996	13.3768	-208.548	0.0293	1.8917	-23.4432	4.4838	-208.2731	-29.356	22.2697	-208.823
3.248	-26.4039	13.0591	-208.7252	0.0211	1.881	-23.5394	4.1216	-208.5274	-29.2684	21.9967	-208.9231
3.264	-26.7509	14.1502	-209.9784	0.0523	1.8503	-24.2947	5.593	-209.5125	-29.2072	22.7075	-210.4443
3.28	-26.8595	13.7375	-210.5507	0.0207	1.8507	-24.3879	5.1376	-210.3654	-29.3312	22.3374	-210.736
3.296	-28.0079	14.8388	-211.4067	0.0271	1.859	-25.3108	5.7394	-211.1496	-30.7051	23.9383	-211.6638
3.312	-27.3007	13.8652	-211.991	0.0601	1.8541	-24.6762	4.851	-211.4257	-29.9253	22.8793	-212.5562
3.328	-27.9725	14.5855	-212.682	0.0212	1.8771	-24.9535	5.0387	-212.4699	-30.9915	24.1323	-212.894
3.344	-27.8307	14.9419	-213.4232	0.0387	1.8553	-25.0813	5.5395	-213.0442	-30.5802	24.3444	-213.8023
3.36	-29.0208	14.9481	-214.0748	-0.0545	1.9045	-26.351	7.2469	-214.5193	-31.6906	22.6493	-213.6303
3.376	-28.9573	14.998	-214.7961	-0.0932	1.932	-25.7756	6.5747	-215.638	-32.139	23.4214	-213.9543
3.392	-28.8679	15.5927	-214.9315	-0.1203	1.7644	-27.2978	7.5843	-215.9183	-30.438	23.601	-213.9446
3.408	-28.8881	15.2247	-215.8626	-0.1593	1.7506	-27.4774	7.4656	-217.1294	-30.2987	22.9838	-214.5957
3.424	-28.4434	15.5771	-216.4958	-0.1344	1.7615	-26.9285	7.731	-217.5763	-29.9583	23.4231	-215.4154
3.44	-28.7503	15.6298	-217.4069	-0.1981	1.7171	-27.6657	8.2702	-218.9003	-29.8349	22.9894	-215.9135
3.456	-28.8445	15.637	-218.6069	-0.1453	1.6971	-27.9375	8.4965	-219.6603	-29.7515	22.7775	-217.5535
3.472	-29.281	16.4596	-219.3319	-0.1533	1.7281	-28.1596	9.3898	-220.4378	-30.4024	23.5293	-218.2261
3.488	-29.3062	16.1009	-220.2213	-0.2746	1.7341	-28.2516	9.7019	-222.0482	-30.3609	22.5	-218.3944
3.504	-29.0182	16.7971	-220.8809	-0.2771	1.6658	-28.3899	10.2019	-222.7651	-29.6465	23.3923	-218.9968
3.52	-29.7155	17.2994	-221.5694	-0.2903	1.7123	-28.8267	11.0612	-223.4521	-30.6043	23.5376	-219.6867
3.536	-29.9725	17.3717	-222.3139	-0.3819	1.6718	-29.3596	11.3256	-224.7543	-30.5853	23.4179	-219.8735
3.552	-30.1151	17.6544	-223.1272	-0.3872	1.6182	-29.8318	11.6775	-225.567	-30.3983	23.6314	-220.6874
3.568	-29.8271	17.9261	-224.0766	-0.4534	1.71	-29.0419	12.3235	-226.8328	-30.6123	23.5286	-221.3203
3.584	-30.0576	18.7147	-224.8403	-0.4395	1.677	-29.3686	12.2524	-227.8958	-30.7465	25.177	-221.7847
3.6	-29.1203	18.5499	-225.305	-0.514	1.5611	-29.18	12.4062	-228.7743	-29.0607	24.6936	-221.8357
3.616	-29.7595	18.5426	-226.0598	-0.5848	1.7134	-28.935	12.802	-229.8991	-30.5839	24.2832	-222.2204
3.632	-30.17	19.2659	-226.7618	-0.6212	1.7464	-29.1771	13.6699	-230.8292	-31.163	24.8619	-222.6945
3.648	-29.7968	19.0841	-227.8951	-0.6062	1.7711	-28.6599	13.4855	-231.856	-30.9336	24.6828	-223.9341
3.664	-30.3575	19.4665	-228.172	-0.6331	1.8531	-28.6619	13.6213	-232.6381	-32.0532	25.3116	-223.706
3.68	-29.8942	19.4268	-229.0798	-0.5919	1.8786	-27.8735	13.0694	-233.5645	-31.915	25.7842	-224.5951
3.696	-29.4519	18.3672	-229.506	-0.7695	1.8693	-27.9072	13.3472	-234.5936	-30.9966	23.3872	-224.4183
3.712	-29.6834	18.3893	-230.2927	-0.7447	2.0235	-27.2793	13.4462	-235.3589	-32.0876	23.3324	-225.2264
3.728	-29.4405	19.5454	-231.0931	-0.6806	2.0138	-26.7376	13.849	-236.1977	-32.1435	25.2418	-225.9885
3.744	-28.9837	19.0961	-231.7973	-0.7618	2.0759	-26.0095	13.7172	-237.6605	-31.9578	24.4749	-225.9341
3.76	-29.1256	19.1756	-232.4284	-0.7471	2.1343	-25.8787	14.0364	-238.0589	-32.3725	24.3148	-226.7979
3.776	-29.1145	19.1281	-233.9203	-0.7593	2.1928	-25.8435	14.5656	-239.2491	-32.3854	23.6907	-228.5915
3.792	-28.9147	19.156	-234.903	-0.7586	2.3292	-24.7857	14.7978	-240.5928	-33.0436	23.5143	-229.2132
3.808	-29.1274	19.4433	-235.6558	-0.7033	2.346	-24.5288	14.7497	-241.2274	-33.7261	24.1368	-230.0843
3.824	-29.4839	19.4641	-236.4899	-0.6632	2.4129	-24.0744	14.6355	-242.1552	-34.8933	24.2927	-230.8247
3.84	-29.466	19.4101	-237.2966	-0.6472	2.4125	-24.0536	14.5754	-242.7818	-34.8783	24.2447	-231.8114
3.856	-28.7559	19.7126	-238.4834	-0.5577	2.5057	-22.3745	15.002	-243.4306	-35.1372	24.4232	-233.5361
3.872	-28.8814	18.8788	-239.4932	-0.5791	2.5805	-22.1298	14.6356	-244.7069	-35.6331	23.122	-234.2795
3.888	-29.5284	19.5216	-240.5334	-0.4923	2.5765	-21.9168	14.6957	-245.3668	-37.14	24.3475	-235.7
3.904	-29.1591	19.7295	-241.1125	-0.4813	2.5212	-21.9356	14.5688	-245.7485	-36.3825	24.8901	-236.4764
3.92	-28.9376	19.9248	-241.9607	-0.4704	2.5727	-21.3497	15.0726	-246.5408	-36.5255	24.7771	-237.3807
3.936	-28.9849	19.9193	-242.9461	-0.3892	2.5942	-20.4098	14.6928	-247.0645	-37.5599	25.1458	-238.8276
3.952	-29.5188	20.1613	-244.1416	-0.3866	2.6054	-21.4933	15.3921	-247.9426	-37.5444	24.9305	-240.3406
3.968	-28.4662	19.2852	-245.3459	-0.347	2.6576	-20.3044	14.995	-248.6805	-36.6281	23.5754	-242.0113
3.984	-28.5006	19.8219	-245.6105	-0.2761	2.6467	-19.586	15.0109	-248.4802	-37.4152	24.6329	-242.7408
4	-29.0171	19.3645	-246.8914	-0.2222	2.6936	-19.7617	14.9164	-249.2112	-38.2725	23.8125	-244.5716
4.016	-27.8708	18.5186	-248.5346	-0.1769	2.7283	-17.6493	14.0359	-250.5304	-38.0923	23.0012	-246.5389
4.032	-27.4981	18.3198	-248.5673	-0.1875	2.6795	-18.8341	14.0046	-250.4036	-36.1621	22.6349	-246.731
4.048	-28.1928	18.889	-249.7301	-0.1555	2.7511	-19.0138	15.111	-251.2858	-37.3718	22.667	-248.1745

Rock1	time	pos(x)	pos(y)	pos(z)	el	az	x1	y1	z1	x2	y2	z2
	4.064	-27.6679	18.7841	-251.1099	-0.1294	2.8847	-19.5217	16.6439	-252.2059	-35.8141	20.9244	-250.014
	4.08	-29.5081	19.0607	-252.1316	-0.055	2.9616	-21.9034	17.677	-252.5572	-37.1127	20.4443	-251.7061
	4.096	-29.7919	19.3724	-253.3925	-0.0023	3.0112	-21.8133	18.3265	-253.4111	-37.7705	20.4183	-253.3739
	4.112	-29.1558	17.9558	-253.569	0.1434	2.9273	-22.1863	16.4392	-252.5391	-36.1253	19.4724	-254.5989
	4.128	-29.4982	18.4722	-254.6058	0.1523	3.05	-22.4727	17.8271	-253.5227	-36.5237	19.1172	-255.6889
	4.144	-29.3401	18.1006	-255.7143	0.2605	3.0338	-22.6445	17.3762	-253.919	-36.0358	18.8251	-257.5095
	4.16	-28.7115	18.224	-256.4909	0.2229	-3.1223	-22.473	18.3444	-255.0764	-34.9499	18.1036	-257.9053
	4.176	-29.6144	19.5119	-258.8118	0.3961	2.968	-22.9038	18.335	-255.9623	-36.3251	20.6888	-261.6613
	4.192	-27.6536	18.5017	-259.4209	0.4486	3.0806	-22.6791	18.1977	-257.0222	-32.6282	18.8056	-261.8195
	4.208	-27.1528	18.3507	-260.2809	0.4441	2.8761	-21.4037	16.7874	-257.4463	-32.9019	19.914	-263.1155
	4.224	-27.6566	18.4061	-261.3917	0.5004	2.9459	-22.4991	17.3838	-258.5165	-32.8142	19.4285	-264.2669
	4.24	-28.065	18.278	-261.5577	0.5673	3.097	-23.6391	18.0803	-258.7347	-32.4908	18.4757	-264.3807
	4.256	-28.4128	17.7131	-261.8739	0.5718	3.0783	-22.6132	17.3452	-258.1345	-34.2124	18.0809	-265.6133
	4.272	-28.2486	17.1526	-262.4467	0.676	3.079	-22.7796	16.81	-258.0514	-33.7176	17.4953	-266.842
	4.288	-28.5165	17.4914	-263.7174	0.6674	-3.1135	-23.5241	17.6319	-259.7821	-33.5088	17.351	-267.6527
	4.304	-29.298	17.2132	-264.7948	0.5681	3.1316	-22.1539	17.1418	-260.2347	-36.442	17.2845	-269.355
	4.32	-27.9074	16.8876	-265.08	0.5783	-3.102	-20.9994	17.1615	-260.567	-34.8154	16.6138	-269.593
	4.336	-28.3343	16.852	-266.3173	0.557	-3.0236	-22.2051	17.5789	-262.4734	-34.4634	16.1251	-270.1612
	4.352	-28.0403	16.9793	-267.2432	0.5183	-3.0652	-21.5311	17.4774	-263.5197	-34.5496	16.4812	-270.9666
	4.368	-28.032	16.4423	-267.4595	0.4487	-2.928	-21.2115	17.9218	-264.0998	-34.8524	14.9629	-270.8192
	4.384	-28.819	16.4063	-268.1961	0.3989	-3.0427	-20.9327	17.1888	-264.8558	-36.7053	15.6237	-271.5364
	4.4	-29.5024	16.6563	-269.383	0.3552	-3.0477	-21.0748	17.4499	-266.2436	-37.9299	15.8628	-272.5225
	4.416	-28.5978	15.3688	-269.7225	0.2442	3.1219	-18.6972	15.1737	-267.2548	-38.4985	15.5638	-272.1902
	4.432	-29.2141	15.5765	-270.4162	0.2647	-3.0996	-20.3621	15.9488	-268.0143	-38.066	15.2041	-272.8182
	4.448	-27.8121	14.0084	-271.7978	0.2738	-3.1086	-18.6291	14.3114	-269.2174	-36.9951	13.7054	-274.3782
	4.464	-30.0946	15.9679	-273.3271	0.2005	-3.0172	-21.827	17.002	-271.6339	-38.3622	14.9338	-275.0203
	4.48	-30.8841	15.2268	-273.7645	0.1498	-3.1098	-22.4537	15.4951	-272.4916	-39.3145	14.9585	-275.0375
	4.496	-30.1454	14.4573	-274.1413	0.1543	-3.1262	-21.9089	14.5838	-272.8604	-38.382	14.3309	-275.4223
	4.512	-31.6274	14.6775	-275.3024	0.1969	3.1183	-22.4889	14.4642	-273.4793	-40.766	14.8908	-277.1255
	4.528	-31.3662	14.4742	-276.2815	0.3501	2.604	-20.4717	7.9787	-271.6499	-42.2607	20.9697	-280.9132

Rockan2	v1=	time	pos(x)	pos(y)	pos(z)	el	az	x1	y1	z1	x2	y2	z2
	2.805	0	0	0	0	-1.3431	-0.4583	-1.0736	0.5296	-5.166	1.0736	-0.5296	5.166
		0.016	2.1797	-0.0715	-5.5765	-0.8129	0.0319	-2.5339	-0.2221	-10.5596	6.8934	0.0791	-0.5933
		0.032	1.1232	-0.4032	-8.9761	-0.6223	-0.0129	-4.0965	-0.3357	-12.7208	6.3428	-0.4706	-5.2315
		0.048	0.0413	-0.9228	-12.4968	-0.2442	-0.0368	-6.2738	-0.6902	-14.0711	6.3564	-1.1554	-10.9224
		0.064	-0.6934	-0.7405	-14.747	0.1678	-0.0507	-7.6373	-0.3879	-13.5692	6.2505	-1.0931	-15.9247
		0.08	-2.6173	-1.271	-17.3072	0.3813	0.0663	-8.1222	-1.6365	-15.0956	2.8875	-0.9055	-19.5188
		0.096	-2.7506	-1.1265	-18.2462	0.5453	0.1041	-7.7679	-1.6508	-15.1855	2.2667	-0.6023	-21.3069
		0.112	-3.0753	-0.4809	-18.1435	-0.7153	0.8413	-6.2722	-4.0571	-22.3109	0.1216	3.0952	-13.9761
		0.128	-2.8128	-1.2347	-21.1172	-0.7036	1.2122	-4.3282	-5.2784	-24.7814	-1.2973	2.809	-17.453
		0.144	-2.7269	-1.0314	-22.4216	-0.7442	1.4651	-3.2107	-5.5892	-26.6419	-2.2431	3.5264	-18.2012
		0.16	-2.0879	-1.3665	-24.0922	-0.7414	1.7782	-1.1347	-5.8973	-28.332	-3.0412	3.1642	-19.8524
		0.176	-3.0125	-0.8699	-26.5891	-0.6675	1.6381	-2.7208	-5.1987	-30.0086	-3.3042	3.4589	-23.1696
		0.192	-2.8262	-0.996	-28.4409	-0.692	1.6547	-2.4592	-5.3611	-32.0709	-3.1931	3.3691	-24.8109
		0.208	-2.8488	-1.2312	-30.278	-0.7108	1.6648	-2.4199	-5.7808	-34.2118	-3.2777	3.3184	-26.3442
		0.224	-2.3318	-1.7686	-32.1265	-0.7576	1.6951	-1.7248	-6.6254	-36.7567	-2.9388	3.0883	-27.4964
		0.24	-2.5402	-1.6581	-33.6099	-0.6397	1.7175	-1.8801	-6.1255	-36.9698	-3.2004	2.8093	-30.25
		0.256	-1.9066	-1.4124	-35.1895	-0.7189	1.7806	-0.9958	-5.6903	-39.0174	-2.8173	2.8656	-31.3617
		0.272	-1.769	-0.8763	-36.7144	-0.6989	1.6051	-1.6063	-5.6209	-40.7043	-1.9318	3.8682	-32.7245
		0.288	-1.8482	-0.493	-37.0767	-1.4997	-0.798	-2.1923	-0.1402	-30.1597	-1.5041	-0.8459	-43.9938
		0.304	-1.6433	-0.9425	-38.0218	1.5263	-0.7851	-1.845	-0.741	-31.6196	-1.4416	-1.1441	-44.4239
		0.32	-1.5706	-0.647	-41.1625	1.5362	-0.3873	-1.7755	-0.5634	-34.7673	-1.3657	-0.7306	-47.5577
		0.336	-1.2297	-0.3052	-41.7954	1.4419	-0.4562	-2.0847	0.1143	-34.4457	-0.3747	-0.7248	-49.1451
		0.352	-0.6188	-1.1529	-45.7055	1.4527	-0.191	-1.47	-0.9884	-38.3969	0.2325	-1.3175	-53.0141
		0.368	-0.15	-1.3104	-46.9582	1.4762	-0.1209	-0.7645	-1.2358	-40.4361	0.4645	-1.3851	-53.4803
		0.384	-0.5716	-1.109	-48.9961	1.4848	0.7096	-0.9443	-1.4291	-43.2939	-0.1988	-0.7889	-54.6983
		0.4	-0.9051	-1.0927	-50.6733	1.4921	0.6576	-1.2819	-1.3837	-44.633	-0.5283	-0.8017	-56.7136
		0.416	0.6459	-1.1551	-52.7745	1.4697	0.3915	0.0333	-1.408	-46.2439	1.2585	-0.9022	-59.3051
		0.432	0.9058	-0.9314	-54.1428	1.5172	0.2751	0.5646	-1.0277	-47.5381	1.2469	-0.8351	-60.7475
		0.448	0.5873	-0.8354	-56.1152	1.4625	0.8273	0.1733	-1.2856	-50.4899	1.0012	-0.3852	-61.7405
		0.464	1.176	-1.3643	-58.2937	1.4601	-0.1918	0.4363	-1.2206	-51.5141	1.9158	-1.508	-65.0733
		0.48	1.6925	-1.8485	-60.6146	1.4124	-0.2944	0.5654	-1.5067	-53.2403	2.8196	-2.1903	-67.9889
		0.496	2.7639	-1.9614	-62.7716	1.4591	-0.6823	2.115	-1.4342	-55.3192	3.4127	-2.4886	-70.2241

Rock2	time	pos(x)	pos(y)	pos(z)	el	az	x1	y1	z1	x2	y2	z2
	0.512	3.0833	-1.9527	-64.7442	1.4606	0.0218	2.3142	-1.9694	-57.7927	3.8524	-1.936	-71.6957
	0.528	3.5523	-2.1612	-66.9893	1.498	-0.3659	3.0526	-1.9698	-59.6488	4.0519	-2.3527	-74.3298
	0.544	3.7741	-1.7881	-68.6673	1.4576	-0.0167	2.9683	-1.7746	-61.5752	4.5799	-1.8016	-75.7593
	0.56	4.6958	-2.083	-70.7614	1.4928	0.1207	4.1195	-2.1529	-63.335	5.2721	-2.0131	-78.1878
	0.576	4.7868	-2.3284	-73.1812	1.4658	-0.1087	4.0276	-2.2455	-65.9332	5.546	-2.4113	-80.4291
	0.592	5.0605	-2.1087	-74.8058	1.5214	-0.0682	4.7174	-2.0853	-67.8498	5.4035	-2.1321	-81.7618
	0.608	5.9184	-2.3517	-76.7311	1.4719	0.1778	5.2913	-2.4644	-70.3088	6.5454	-2.239	-83.1534
	0.624	6.1005	-2.4038	-79.2082	1.3784	-0.4901	4.8133	-1.7171	-71.7184	7.3877	-3.0905	-86.698
	0.64	6.6715	-2.4105	-81.5774	1.4261	-0.4415	5.6706	-1.9374	-73.9819	7.6725	-2.8837	-89.1729
	0.656	7.0525	-2.3532	-83.1162	1.4501	-0.6079	6.3216	-1.8446	-75.7728	7.7833	-2.8618	-90.4597
	0.672	7.1918	-2.3127	-85.4411	1.48	-0.8257	6.7365	-1.8192	-78.0683	7.6471	-2.8063	-92.814
	0.688	7.3164	-2.2739	-87.3414	1.4918	-1.3568	7.2011	-1.7433	-80.4822	7.4317	-2.8046	-94.2007
	0.704	7.983	-2.378	-89.2011	1.3629	-0.6046	6.7378	-1.5177	-82.026	9.2283	-3.2383	-96.3762
	0.72	8.3914	-2.8989	-91.8619	1.3366	-0.686	7.0826	-1.8275	-84.7723	9.7001	-3.9702	-98.9516
	0.736	8.9542	-3.0748	-94.0596	1.3148	-0.7839	7.6011	-1.7256	-86.7585	10.3074	-4.4239	-101.3607
	0.752	8.9618	-3.3699	-95.6824	1.3239	-0.7502	7.7425	-2.2336	-89.0683	10.1811	-4.5062	-102.2965
	0.768	9.8499	-3.4766	-98.273	1.2693	-0.727	8.132	-1.9484	-90.8787	11.5678	-5.0047	-105.6674
	0.784	10.8263	-5.1892	-100.4319	1.244	-0.9142	9.2401	-3.131	-92.766	12.4126	-7.2475	-108.0979
	0.8	10.6911	-5.2705	-102.0358	1.0844	-0.9301	8.5501	-2.3992	-95.2628	12.8321	-8.1417	-108.8089
	0.816	10.3293	-5.5768	-103.812	1.0078	-0.9218	7.9871	-2.4895	-97.6722	12.6715	-8.6642	-109.9519
	0.832	10.5806	-6.058	-106.2252	0.9208	-0.9237	7.819	-2.403	-100.199	13.3423	-9.7131	-112.2514
	0.848	11.9649	-6.6432	-108.4168	0.919	-0.9318	9.4109	-3.2057	-102.8044	14.5188	-10.0807	-114.0293
	0.864	11.9321	-6.5753	-110.6514	0.8048	-0.9148	8.8094	-2.5182	-105.3296	15.0547	-10.6323	-115.9732
	0.88	11.9694	-7.2946	-112.4698	0.7742	-0.8511	8.5075	-3.3453	-107.3339	15.4312	-11.244	-117.6057
	0.896	13.0769	-7.6528	-114.4695	0.7691	-1.0033	10.5953	-3.7596	-110.0008	15.5584	-11.5461	-118.9381
	0.912	12.8736	-7.8992	-116.0223	0.7299	-1.059	10.295	-3.3089	-111.3111	15.4523	-12.4895	-120.7335
	0.928	13.6882	-8.4622	-118.4807	0.6723	-1.1653	11.465	-3.2831	-113.9943	15.9113	-13.6414	-122.9667
	0.944	13.896	-8.5814	-120.3605	0.5839	-1.2154	12.0731	-3.6697	-116.899	15.7189	-13.4932	-123.8219
	0.96	14.3089	-8.9757	-122.3149	0.5358	-1.2365	12.4322	-3.5724	-118.9191	16.1856	-14.379	-125.7107
	0.976	14.2424	-9.0459	-123.8046	0.4841	-1.2881	12.5287	-3.1454	-120.5739	15.9561	-14.9465	-127.0353
	0.992	14.5004	-9.6843	-125.7119	0.3985	-1.3133	12.9861	-3.9341	-123.2087	16.0147	-15.4346	-128.2152
	1.008	15.0681	-10.3297	-127.41	0.4098	-1.3263	13.4862	-3.9888	-124.5715	16.6499	-16.6705	-130.2486
	1.024	15.4023	-10.6674	-128.8404	0.3149	-1.3459	14.0361	-4.6965	-126.845	16.7685	-16.6384	-130.8358
	1.04	15.6528	-10.9695	-130.5534	0.2627	-1.4394	14.8026	-4.5341	-128.8078	16.503	-17.405	-132.2991
	1.056	16.2397	-11.287	-131.7528	0.167	-1.5188	15.902	-4.7996	-130.6575	16.5774	-17.7744	-132.8481
	1.072	17.0031	-11.1249	-133.0535	0.1114	-1.5572	16.9166	-4.7458	-132.3397	17.0896	-17.5039	-133.7673
	1.088	17.6662	-11.9856	-134.9478	0.1298	-1.6676	18.2948	-5.5144	-134.0989	17.0375	-18.4569	-135.7967
	1.104	18.0624	-12.0424	-135.9494	0.0894	-1.7101	18.9774	-5.5157	-135.3585	17.1474	-18.5692	-136.5403
	1.12	19.5633	-12.1738	-137.1369	0.0174	-1.9567	22.3482	-5.3192	-137.0083	16.7785	-19.0284	-137.2655
	1.136	19.8553	-12.6163	-138.1697	0.0144	-1.9752	22.7793	-5.7845	-138.063	16.9313	-19.4481	-138.2764
	1.152	22.3065	-13.2917	-139.7667	0.0115	-2.1533	26.4331	-7.0276	-139.6804	18.1798	-19.5558	-139.853
	1.168	22.8787	-13.189	-140.3717	0.0275	-2.222	27.6767	-6.8937	-140.1538	18.0808	-19.4843	-140.5896
	1.184	24.0145	-13.6648	-141.6785	0.0205	-2.2391	29.2999	-6.9698	-141.5037	18.7291	-20.3599	-141.8533
	1.2	23.3318	-13.3591	-142.0363	0.0089	-2.1234	27.3918	-6.7758	-141.9673	19.2718	-19.9425	-142.1053
	1.216	24.5827	-13.136	-142.6574	0.0028	-2.2042	29.1979	-6.8516	-142.6358	19.9674	-19.4204	-142.679
	1.232	25.5967	-13.9051	-143.9272	0.088	-2.3518	31.9882	-7.4568	-143.1258	19.2053	-20.3535	-144.7286
	1.248	26.1236	-13.8567	-144.6751	0.1144	-2.4344	33.1867	-7.8198	-143.6073	19.0606	-19.8937	-145.7429
	1.264	26.2627	-14.9108	-145.504	0.1318	-2.4494	33.4066	-8.9881	-144.2738	19.1188	-20.8335	-146.7343
	1.28	26.4778	-14.7243	-145.6929	0.1638	-2.4402	33.1806	-9.0631	-144.2427	19.775	-20.3854	-147.1431
	1.296	26.8372	-14.9356	-146.38	0.2187	-2.4149	33.2172	-9.2635	-144.4826	20.4572	-20.6077	-148.2775
	1.312	27.3124	-14.4473	-147.0123	0.3617	-2.5436	34.1474	-9.7917	-143.8838	20.4775	-19.103	-150.1408
	1.328	27.573	-15.0503	-147.7352	0.4126	-2.5252	34.2893	-10.2917	-144.1321	20.8566	-19.809	-151.3384
	1.344	27.763	-14.5417	-148.0178	0.4186	-2.5615	34.2415	-10.2962	-144.5716	21.2845	-18.7873	-151.4639
	1.36	28.4186	-13.8178	-148.149	0.4443	-2.586	35.1714	-9.6252	-144.3653	21.6658	-18.0103	-151.9327
	1.376	28.7682	-14.2913	-148.5955	0.5561	-2.5278	34.8712	-9.9916	-143.9555	22.6652	-18.591	-153.2355
	1.392	29.5513	-14.6557	-149.0274	0.5534	-2.5535	35.8011	-10.4884	-144.3872	23.3015	-18.823	-153.6677
	1.408	29.4397	-15.3687	-149.5133	0.5878	-2.5112	35.4146	-11.0088	-144.5845	23.4649	-19.7286	-154.4422
	1.424	29.7723	-14.5038	-149.8142	0.5745	-2.5558	36.0211	-10.3578	-144.9601	23.5235	-18.6499	-154.6683
	1.44	30.0419	-15.1373	-150.6558	0.664	-2.4908	35.6332	-10.8794	-145.1559	24.4506	-19.3951	-155.1557
	1.456	30.2221	-15.4045	-151.1334	0.6923	-2.5713	35.8812	-11.7746	-145.558	24.563	-19.0344	-156.7088
	1.472	30.4658	-15.3299	-151.563	0.7243	-2.5942	35.9551	-11.9836	-145.8756	24.9765	-18.6761	-157.2503
	1.488	30.6751	-15.3896	-152.2017	0.7254	-2.5101	35.8072	-11.6359	-146.564	25.543	-19.1433	-157.8394
	1.504	30.777	-15.4076	-152.673	0.7062	-2.5699	36.5491	-11.6937	-146.818	25.0049	-19.1215	-158.5279
	1.52	30.683	-15.4651	-153.3095	0.7084	-2.6116	36.3933	-12.1197	-147.6394	24.9726	-18.8104	-158.9797
	1.536	31.2614	-16.2962	-154.4484	0.7499	-2.5814	36.5089	-13.0049	-148.679	26.0138	-19.5875	-160.2178
	1.552	31.1551	-16.3498	-155.3165	0.7855	-2.6082	36.3949	-13.2558	-149.23	25.9154	-19.4438	-161.403

Rock2

time	pos(x)	pos(y)	pos(z)	el	az	x1	y1	z1	x2	y2	z2
1.568	31.4165	-16.0622	-155.644	0.8175	-2.565	36.2463	-12.9215	-149.5	26.5867	-19.2029	-161.7879
1.584	31.0413	-16.8502	-156.3107	0.8382	-2.6333	36.052	-14.0588	-149.9347	26.0307	-19.6417	-162.6867
1.6	31.2013	-17.292	-157.2139	0.7892	-2.7102	36.8623	-14.6864	-150.9344	25.5403	-19.8977	-163.4933
1.616	31.0986	-17.5938	-158.2884	0.7942	-2.7173	36.8824	-14.9807	-151.8284	25.3147	-20.2069	-164.7485
1.632	32.1679	-17.5314	-158.7532	0.7229	-2.711	38.2017	-14.7602	-152.8951	26.1341	-20.3027	-164.6113
1.648	30.7548	-18.1445	-160.0962	0.7879	-2.5596	35.5624	-14.9811	-154.312	25.9471	-21.308	-165.8803
1.664	30.9962	-17.5687	-160.7405	0.7674	-2.6183	36.0308	-14.664	-155.1333	25.9616	-20.4734	-166.3477
1.68	30.8336	-18.0304	-161.5656	0.7775	-2.6865	36.1535	-15.427	-155.7355	25.5136	-20.6338	-167.3956
1.696	30.3035	-18.2057	-162.373	0.7415	-2.6437	35.8222	-15.206	-156.6208	24.7848	-21.2053	-168.1251
1.712	30.8976	-18.0005	-163.3767	0.7143	-2.664	36.4707	-15.1164	-157.9358	25.3244	-20.8846	-168.8177
1.728	30.8094	-18.6015	-164.6387	0.7092	-2.7608	36.7243	-16.2334	-159.171	24.8945	-20.9696	-170.1064
1.744	29.9702	-18.5319	-165.6735	0.6886	-2.6759	35.8931	-15.5557	-160.2184	24.0472	-21.5082	-171.1286
1.76	30.8555	-18.9293	-166.7303	0.6235	-2.7127	37.5144	-15.8845	-161.4643	24.1965	-21.9741	-171.9964
1.776	30.0527	-18.1924	-167.3458	0.6594	-2.6153	35.7531	-14.881	-162.2363	24.3524	-21.5038	-172.4553
1.792	29.6884	-19.2154	-168.6107	0.6632	-2.7539	36.2077	-16.5529	-163.1095	23.1691	-21.8779	-174.112
1.808	29.5845	-18.8602	-169.4137	0.5913	-2.66	35.9628	-15.5264	-164.5814	23.2063	-22.194	-174.246
1.824	29.8095	-19.0223	-170.2152	0.576	-2.6968	36.2335	-15.9601	-165.5936	23.3855	-22.0845	-174.8368
1.84	29.0555	-19.1421	-171.0191	0.5943	-2.7436	35.4535	-16.452	-166.3288	22.6575	-21.8321	-175.7095
1.856	28.6416	-19.1982	-171.7632	0.5349	-2.718	35.2771	-16.206	-167.45	22.0061	-22.1905	-176.0764
1.872	28.681	-18.8861	-173.0224	0.4704	-2.7724	35.4271	-16.2762	-169.3444	21.935	-21.496	-176.7004
1.888	27.5941	-18.9235	-173.7888	0.4158	-2.7371	34.9055	-15.7939	-170.2775	20.2827	-22.0531	-177.3001
1.904	26.816	-19.3355	-174.4362	0.3985	-2.7681	34.2098	-16.4383	-171.0929	19.4222	-22.2328	-177.7795
1.92	26.5683	-18.2668	-175.3546	0.3835	-2.7988	33.6186	-15.7504	-172.3345	19.518	-22.7832	-178.3748
1.936	25.8676	-19.1223	-176.1795	0.3461	-2.9128	32.6136	-17.5515	-173.6813	19.1216	-20.6931	-178.6777
1.952	25.585	-19.0378	-176.7751	0.2261	-2.9841	32.7756	-17.896	-175.1007	18.3944	-20.1797	-178.4496
1.968	25.1286	-19.0673	-177.5651	0.2051	-2.928	32.3744	-17.4958	-176.0228	17.8828	-20.6388	-179.1075
1.984	25.1536	-18.7423	-177.4792	0.0885	-2.9292	32.5204	-17.1533	-176.8106	17.7869	-20.3312	-178.1478
2	23.0306	-20.1762	-177.4785	0.0502	-3.012	29.9592	-19.2729	-177.1271	16.1019	-21.0794	-177.8299
2.016	22.7326	-21.0789	-177.8252	-0.0864	-2.9415	29.0698	-19.7934	-178.3855	16.3954	-22.3644	-177.2649
2.032	21.7703	-21.8276	-178.2557	-0.1285	-2.9516	28.3788	-20.5569	-179.1255	15.1617	-23.0983	-177.3859
2.048	22.2242	-19.9059	-179.0072	-0.1305	-2.6917	29.4612	-16.4113	-180.0616	14.9872	-23.4006	-177.9527
2.064	21.7683	-19.8019	-179.6302	-0.1633	-2.7071	29.1951	-16.3555	-180.9795	14.3415	-23.2484	-178.2808
2.08	21.3468	-19.7719	-180.1888	-0.1183	-2.626	28.7251	-15.5901	-181.1969	13.9685	-23.9536	-179.1806
2.096	20.3901	-20.9776	-180.3832	-0.1812	-2.5784	27.1695	-16.6973	-181.8525	13.6108	-25.2578	-178.914
2.112	19.8165	-22.2447	-180.5971	-0.2363	-2.5916	26.7459	-17.9961	-182.5546	12.887	-26.4933	-178.6395
2.128	19.6615	-22.3729	-181.2696	-0.2666	-2.5107	26.1491	-17.6333	-183.4641	13.1738	-27.1125	-179.075
2.144	18.9253	-22.5992	-181.5232	-0.2419	-2.4256	24.9094	-17.3934	-183.4799	12.9412	-27.805	-179.5665
2.16	18.146	-23.0712	-182.0039	-0.2624	-2.4633	24.2536	-18.149	-184.1111	12.0383	-27.9934	-179.8967
2.176	17.9151	-23.1222	-182.2481	-0.2892	-2.5154	24.6685	-18.237	-184.7283	11.1616	-28.0073	-179.7679
2.192	18.3278	-23.4566	-182.9654	-0.3361	-2.5559	24.8335	-19.141	-185.6926	11.8221	-27.7722	-180.2382
2.208	18.256	-23.7982	-183.3832	-0.366	-2.6424	24.6137	-20.3316	-186.1583	11.8982	-27.2649	-180.608
2.224	17.5888	-24.7261	-183.4024	-0.3797	-2.5886	24.2491	-20.615	-186.5263	10.9284	-28.8372	-180.2786
2.24	17.1222	-24.4627	-183.4836	-0.3945	-2.5967	23.2237	-20.7649	-186.4542	11.0206	-28.1605	-180.5129
2.256	17.0101	-24.7852	-183.872	-0.4535	-2.64	22.8535	-21.5806	-187.1201	11.1667	-27.9898	-180.624
2.272	16.4214	-24.7655	-184.176	-0.4756	-2.6526	22.2869	-21.6448	-187.5982	10.556	-27.8862	-180.7539
2.288	16.1938	-25.509	-183.8042	-0.469	-2.6513	21.9183	-22.4533	-187.0919	10.4692	-28.5648	-180.5164
2.304	16.2379	-25.5332	-184.5329	-0.4894	-2.6388	21.6186	-22.574	-187.8036	10.8571	-28.4924	-181.2621
2.32	15.5314	-25.0478	-184.8104	-0.4859	-2.6319	20.6252	-22.2009	-187.8923	10.4377	-27.8947	-181.7285
2.336	15.5078	-25.1324	-185.1193	-0.5543	-2.6285	20.4566	-22.3442	-188.6355	10.5591	-27.9207	-181.6031
2.352	15.661	-24.9032	-185.4413	-0.5286	-2.61	21.0275	-21.7476	-189.077	10.2944	-28.0589	-181.8056
2.368	15.2818	-24.8369	-185.7596	-0.5819	-2.5351	20.3024	-21.354	-189.7798	10.2612	-28.3198	-181.7394
2.384	14.869	-25.4696	-186.1652	-0.6029	-2.5758	19.6169	-22.4543	-190.0374	10.1211	-28.4849	-182.2929
2.4	14.7916	-25.1947	-186.505	-0.6247	-2.5486	19.4418	-22.0608	-190.5487	10.1414	-28.3286	-182.4613
2.416	13.6801	-25.0609	-186.7671	-0.6281	-2.5358	18.7354	-21.559	-191.2333	8.6248	-28.5628	-182.3009
2.432	13.5144	-25.6546	-187.2557	-0.6479	-2.5331	18.4518	-22.2145	-191.8101	8.577	-29.0946	-182.7014
2.448	13.4366	-25.4564	-188.0493	-0.6556	-2.5742	18.7637	-22.0612	-192.9074	8.1095	-28.8516	-183.1913
2.464	13.0371	-25.4735	-188.1665	-0.617	-2.5816	18.3279	-22.1563	-192.596	7.7464	-28.7906	-183.737
2.48	13.3493	-26.0612	-188.4251	-0.6383	-2.5585	18.6476	-22.5661	-193.134	8.0509	-29.5563	-183.7163
2.496	13.4745	-25.4677	-189.0933	-0.6955	-2.5947	18.5621	-22.3701	-194.0648	8.387	-28.5653	-184.1218
2.512	13.0786	-25.479	-189.7763	-0.6565	-2.6001	18.1334	-22.4388	-194.3217	8.0237	-28.5192	-185.2308
2.528	12.8996	-25.8836	-190.2561	-0.6113	-2.5492	18.4786	-22.1287	-194.9694	7.3205	-29.6385	-185.5429
2.544	12.8873	-25.7895	-191.1309	-0.6058	-2.5002	17.9558	-22.0052	-195.5126	7.8188	-29.5738	-186.7492
2.56	12.8441	-26.9425	-191.3112	-0.5737	-2.4343	18.1447	-22.4114	-195.8174	7.5436	-31.4736	-186.805
2.576	12.6926	-26.3742	-192.0727	-0.6136	-2.4668	17.7558	-22.3232	-196.6399	7.6294	-30.4252	-187.5055
2.592	12.9045	-26.2355	-192.8481	-0.563	-2.3852	18.117	-21.317	-197.3717	7.692	-31.1541	-188.3244
2.608	13.3479	-25.8661	-193.37	-0.6035	-2.5237	18.6324	-22.1101	-197.8391	8.0634	-29.6222	-188.9009

Rock2

time	pos(x)	pos(y)	pos(z)	el	az	x1	y1	z1	x2	y2	z2
2.624	13.3142	-25.934	-194.1273	-0.5527	-2.4968	18.8482	-21.7725	-198.398	7.7802	-30.0955	-189.8567
2.64	13.4136	-25.4756	-195.1782	-0.5287	-2.5291	19.3783	-21.2844	-199.4371	7.449	-29.6669	-190.9193
2.656	13.7036	-25.3497	-195.6137	-0.5178	-2.5016	19.596	-20.9624	-199.7988	7.8113	-29.7369	-191.4286
2.672	13.8503	-25.637	-196.3586	-0.4921	-2.5582	20.0094	-21.5721	-200.3146	7.6912	-29.7018	-192.4027
2.688	13.8715	-25.6414	-196.7888	-0.4903	-2.6062	19.8856	-22.0741	-200.5212	7.8575	-29.2087	-193.0563
2.704	13.6885	-26.0218	-197.4964	-0.4483	-2.4985	19.7542	-21.4764	-201.142	7.6229	-30.5672	-193.8508
2.72	13.7397	-26.1352	-198.1519	-0.4203	-2.5097	20.3714	-21.2804	-201.8256	7.1081	-30.9899	-194.4782
2.736	13.597	-25.6286	-198.5846	-0.3814	-2.4948	20.3591	-20.5219	-201.9826	6.8349	-30.7354	-195.1866
2.752	13.9095	-25.9378	-199.2366	-0.315	-2.4895	20.9015	-20.5988	-202.1034	6.9174	-31.2768	-196.3697
2.768	14.1642	-25.8111	-199.8886	-0.2824	-2.4345	21.0807	-19.9005	-202.5286	7.2477	-31.7218	-197.2485
2.784	14.1408	-26.0285	-200.7269	-0.2577	-2.4002	21.3522	-19.4256	-203.3039	6.9294	-32.6314	-198.1499
2.8	14.014	-25.8224	-201.4878	-0.2455	-2.4053	21.4448	-19.0872	-204.0001	6.5831	-32.5576	-198.9755
2.816	14.3554	-25.8231	-202.1275	-0.1947	-2.4211	21.2706	-19.7521	-203.942	7.4401	-31.8941	-200.313
2.832	14.5735	-26.181	-202.7663	-0.1569	-2.4025	21.9098	-19.4937	-204.3362	7.2372	-32.8664	-201.1965
2.848	14.2801	-26.2892	-203.2453	-0.1237	-2.4277	22.0429	-19.5646	-204.5225	6.5172	-33.0137	-201.968
2.864	14.6808	-25.7508	-203.9114	-0.0927	-2.4031	22.2279	-18.8811	-204.8601	7.1337	-32.6205	-202.9627
2.88	14.3909	-25.5897	-204.4886	-0.1224	-2.3679	21.4058	-18.7368	-205.6954	7.376	-32.4427	-203.2819
2.896	14.2728	-26.2291	-205.313	-0.0916	-2.3863	21.3312	-19.5834	-206.2033	7.2143	-32.8748	-204.4228
2.912	14.4287	-26.3129	-205.9947	-0.0765	-2.356	21.2007	-19.5381	-206.7293	7.6567	-33.0877	-205.2601
2.928	14.2868	-26.06	-206.4027	-0.0534	-2.4015	21.3327	-19.6249	-206.9129	7.241	-32.4951	-205.8924
2.944	14.2608	-25.3221	-207.2063	-0.0503	-2.3717	21.5188	-18.2852	-207.7153	7.0028	-32.3589	-206.6972
2.96	14.4003	-25.0618	-208.2066	-0.0112	-2.3633	21.7971	-17.7698	-208.3228	7.0034	-32.3538	-208.0903
2.976	14.2927	-24.8327	-208.986	-0.0012	-2.3798	21.4391	-18.0158	-208.9982	7.1462	-31.6496	-208.9739
2.992	13.8178	-24.3135	-209.3738	0.0719	-2.2536	19.7664	-16.9992	-208.6943	7.8693	-31.6279	-210.0532
3.008	13.2275	-25.1299	-210.0649	0.0231	-2.3281	19.1813	-18.8321	-209.8643	7.2737	-31.4277	-210.2654
3.024	12.5613	-25.5487	-210.4222	-0.0137	-2.3325	18.8603	-18.9437	-210.5474	6.2624	-32.1537	-210.2969
3.04	12.4078	-26.2434	-210.9919	0.0237	-2.3219	18.3629	-19.8655	-210.7853	6.4526	-32.6213	-211.1985
3.056	12.4783	-25.9385	-211.7684	0.0402	-2.2509	17.9273	-19.2021	-211.42	7.0294	-32.675	-212.1168
3.072	12.0778	-26.1405	-211.9847	0.06	-2.3147	17.0262	-20.7639	-211.546	7.1293	-31.5171	-212.4234
3.088	11.4294	-26.0823	-212.786	0.0626	-2.3343	16.9687	-20.2945	-212.2837	5.8901	-31.8702	-213.2883
3.104	12.2497	-26.634	-213.085	0.0379	-2.2911	17.4756	-20.6792	-212.7845	7.0237	-32.5889	-213.3854
3.12	12.0817	-26.0997	-213.7246	0.0227	-2.393	17.3457	-21.2097	-213.5616	6.8177	-30.9896	-213.8877
3.136	12.0802	-25.8408	-214.1025	-0.0317	-2.3996	17.0458	-21.2885	-214.3158	7.1145	-30.3932	-213.8891
3.152	11.6574	-25.5059	-214.7948	-0.0178	-2.4599	16.915	-21.2397	-214.9155	6.3997	-29.7722	-214.6741
3.168	11.8387	-25.9606	-215.366	-0.0082	-2.4912	17.213	-21.8721	-215.421	6.4643	-30.0492	-215.3109
3.184	11.4034	-25.9423	-215.9099	-0.0473	-2.531	17.0494	-21.9916	-216.2362	5.7575	-29.8931	-215.5835
3.2	11.773	-25.3499	-216.4632	-0.1113	-2.4723	17.4097	-20.8909	-217.2663	6.1363	-29.8088	-215.6601
3.216	11.4687	-25.2262	-217.1033	-0.115	-2.4815	17.8302	-20.2879	-218.0337	5.1072	-30.1645	-216.1729
3.232	11.1805	-25.1209	-217.8419	-0.0495	-2.5401	17.1046	-21.0547	-218.198	5.2564	-29.187	-217.4859
3.248	11.087	-25.1431	-218.3107	-0.1232	-2.4587	16.9479	-20.3753	-219.2461	5.2261	-29.9109	-217.3753
3.264	11.1169	-24.843	-219.3609	-0.1664	-2.4728	17.1345	-20.0869	-220.6492	5.0993	-29.5991	-218.0725
3.28	10.5022	-25.0094	-220.1652	-0.1194	-2.5087	16.2807	-20.7704	-221.0248	4.7237	-29.2484	-219.3056
3.296	10.577	-24.526	-220.8449	-0.1211	-2.5023	16.5574	-20.0796	-221.7515	4.5966	-28.9724	-219.9383
3.312	10.4364	-25.4765	-221.256	-0.166	-2.4758	16.0868	-21.0386	-222.4597	4.786	-29.9144	-220.0522
3.328	10.6104	-24.3808	-222.0955	-0.171	-2.5058	16.2275	-20.2351	-223.301	4.9933	-28.5265	-220.89
3.344	10.1892	-24.885	-222.4599	-0.1962	-2.5117	16.1935	-20.5082	-223.9363	4.1849	-29.2619	-220.9834
3.36	9.9006	-24.8804	-223.2468	-0.2049	-2.5627	16.615	-20.4916	-224.9137	3.1863	-29.2692	-221.58
3.376	9.7337	-25.2857	-223.7478	-0.1848	-2.5593	16.0434	-21.131	-225.1598	3.4239	-29.4404	-222.3359
3.392	9.3338	-24.5362	-224.3019	-0.2375	-2.6084	15.8408	-20.6953	-226.1306	2.8268	-28.3771	-222.4733
3.408	9.4288	-24.7196	-224.9501	-0.2552	-2.5264	15.8015	-20.216	-226.9857	3.056	-29.2232	-222.9145
3.424	8.9866	-25.1252	-225.6162	-0.283	-2.5328	15.0726	-20.883	-227.7739	2.9007	-29.3675	-223.4586
3.44	9.2763	-24.7043	-226.5118	-0.2818	-2.4914	15.0297	-20.329	-228.6046	3.5229	-29.0796	-224.419
3.456	9.1564	-25.3459	-226.6915	-0.3335	-2.5591	15.2895	-21.3062	-229.2359	3.0234	-29.3857	-224.1472
3.472	9.1226	-24.1011	-228.4261	-0.3759	-2.5148	15.0901	-19.779	-231.334	3.1552	-28.4232	-225.5181
3.488	8.9781	-24.2047	-228.6351	-0.3494	-2.6246	15.0736	-20.7391	-231.1898	2.8825	-27.6702	-226.0804
3.504	8.5256	-24.1332	-229.58	-0.3657	-2.6639	14.4109	-21.0863	-232.1178	2.6403	-27.1802	-227.0421
3.52	8.7621	-24.0523	-230.3211	-0.3974	-2.6313	14.894	-20.6201	-233.2704	2.6302	-27.4845	-227.3718
3.536	8.4896	-24.7874	-230.4728	-0.4258	-2.5568	14.1147	-21.063	-233.5328	2.8644	-28.5118	-227.4127
3.552	8.5515	-23.7557	-231.5298	-0.4056	-2.6949	14.256	-21.0237	-234.2457	2.8471	-26.4877	-228.8139
3.568	8.2472	-24.3059	-231.9672	-0.4368	-2.7058	13.8674	-21.689	-234.8618	2.627	-26.9227	-229.0726
3.584	8.1978	-23.896	-232.8266	-0.46	-2.7002	13.6532	-21.3185	-235.8157	2.7424	-26.4735	-229.8374
3.6	8.0133	-24.3949	-233.0861	-0.5295	-2.6882	13.4365	-21.7525	-236.6171	2.5901	-27.0373	-229.5551
3.616	7.8376	-24.3983	-233.8657	-0.3939	-2.7966	13.6247	-22.3187	-236.4219	2.0505	-26.4778	-231.3095
3.632	8.103	-24.3475	-234.714	-0.4923	-2.7587	13.6321	-22.1206	-237.9114	2.574	-26.5744	-231.5167
3.648	7.8965	-24.0202	-235.5356	-0.5112	-2.7227	12.9793	-21.757	-238.6564	2.8138	-26.2834	-232.4148
3.664	8.0365	-24.3754	-236.3974	-0.4633	-2.8483	13.7973	-22.6354	-239.4036	2.2756	-26.1155	-233.3911

Rock2

time	pos(x)	pos(y)	pos(z)	el	az	x1	y1	z1	x2	y2	z2
3.68	7.4799	-24.1129	-236.807	-0.4794	-2.8971	12.9323	-22.7527	-239.7281	2.0276	-25.4731	-233.8859
3.696	7.9019	-24.6475	-237.5454	-0.5028	-2.8836	13.5274	-23.163	-240.7448	2.2764	-26.1319	-234.3459
3.712	7.5869	-24.404	-238.3053	-0.5193	-2.9206	13.4235	-23.0925	-241.7252	1.7503	-25.7156	-234.8855
3.728	7.5543	-24.4554	-238.6036	-0.4819	-3.047	13.3889	-23.9016	-241.6686	1.7198	-25.0092	-235.5386
3.744	7.6296	-24.7763	-239.0129	-0.6464	-2.8686	13.6662	-23.1704	-243.5079	1.893	-26.3822	-234.518
3.76	7.4735	-24.2154	-239.8358	-0.5318	-2.9498	13.3672	-23.0709	-243.3684	1.5798	-25.3598	-236.3032
3.776	7.605	-24.7997	-240.0836	-0.5517	-2.9905	13.6278	-23.883	-243.8333	1.5823	-25.7164	-236.334
3.792	7.4081	-24.353	-240.8481	-0.5386	-2.9949	13.2606	-23.488	-244.3833	1.5556	-25.218	-237.3128
3.808	7.9263	-24.349	-241.5876	-0.4964	-3.0476	13.9004	-23.786	-244.8381	1.9521	-24.9121	-238.3371
3.824	7.4827	-24.3353	-242.3728	-0.4884	-3.0522	13.8132	-23.768	-245.7497	1.1522	-24.9026	-238.9958
3.84	7.9385	-24.5728	-243.0745	-0.486	-3.0589	13.9152	-24.0773	-246.2426	1.9618	-25.0683	-239.9064
3.856	7.7617	-24.7629	-243.9473	-0.436	-3.0805	14.2302	-24.3674	-246.967	1.2932	-25.1585	-240.9276
3.872	7.2112	-24.6379	-244.6222	-0.3913	-3.0845	13.8361	-24.2596	-247.3599	0.5863	-25.0163	-241.8845
3.888	7.3976	-24.4433	-245.5391	-0.4308	-3.0938	13.4161	-24.1556	-248.3086	1.379	-24.7309	-242.7696
3.904	7.6213	-24.3644	-246.6117	-0.3853	-3.0531	14.1481	-23.7854	-249.2691	1.0945	-24.9435	-243.9542
3.92	7.779	-24.5576	-246.6761	-0.4349	-3.0451	13.9328	-23.9619	-249.548	1.6252	-25.1532	-243.8041
3.936	7.5142	-24.7901	-247.6142	-0.4595	-3.0331	13.7727	-24.1081	-250.7292	1.2556	-25.4721	-244.4992
3.952	7.3499	-24.551	-248.2579	-0.4131	-3.076	13.3461	-24.157	-250.8921	1.3536	-24.9451	-245.6237
3.968	7.9284	-24.7042	-249.0999	-0.3871	-3.0848	14.2506	-24.3448	-251.6816	1.6062	-25.0635	-246.5181
3.984	7.3557	-24.5819	-249.6408	-0.367	-3.1001	13.72	-24.3176	-252.0896	0.9913	-24.8462	-247.1919
4	7.3725	-24.0979	-250.9654	-0.3443	-3.0185	13.9055	-23.2899	-253.326	0.8394	-24.906	-248.6049
4.016	7.5495	-25.0043	-250.8147	-0.3937	-2.9803	13.8941	-23.9721	-253.4846	1.2049	-26.0365	-248.1447
4.032	7.0395	-24.7833	-251.7122	-0.3586	-3.032	13.3318	-24.091	-254.0847	0.7473	-25.4757	-249.3396
4.048	7.9451	-24.7069	-252.3064	-0.3563	-2.9872	14.225	-23.7293	-254.6718	1.6651	-25.6845	-249.941
4.064	7.5757	-24.6064	-253.1034	-0.2964	-3.0451	14.5971	-23.9266	-255.2575	0.5542	-25.2862	-250.9494
4.08	8.0748	-24.6513	-253.8817	-0.2668	-2.9636	14.3962	-23.5142	-255.6373	1.7533	-25.7883	-252.1261
4.096	7.9459	-24.3593	-254.8762	-0.2459	-2.9734	14.7061	-23.2115	-256.5969	1.1856	-25.5071	-253.1555
4.112	7.9406	-24.4137	-255.4761	-0.2391	-3.0015	14.5374	-23.4836	-257.1	1.3439	-25.3438	-253.8521
4.128	8.2655	-24.1852	-256.1933	-0.1958	-3.0221	15.0838	-23.3669	-257.555	1.4472	-25.0036	-254.8316
4.144	7.7792	-24.3123	-256.7495	-0.1602	-3.0297	14.7829	-23.525	-257.8884	0.7755	-25.0995	-255.6106
4.16	8.4677	-24.2464	-257.5229	-0.1922	-3.02	15.6308	-23.3711	-258.9272	1.3046	-25.1218	-256.1187
4.176	7.9083	-23.7646	-258.5877	-0.2209	-2.9616	14.4094	-22.5819	-260.0714	1.4072	-24.9474	-257.1039
4.192	8.0198	-23.8527	-259.1451	-0.2289	-2.9671	14.9321	-22.6344	-260.7807	1.1075	-25.0711	-257.5096
4.208	8.053	-23.9992	-259.882	-0.2777	-2.9608	14.3286	-22.852	-261.7008	1.7774	-25.1465	-258.0631
4.224	8.0019	-23.7653	-260.9167	-0.2306	-2.8759	14.488	-22.0001	-262.495	1.5158	-25.5305	-259.3384
4.24	8.1883	-22.9329	-262.007	-0.1832	-2.9255	15.3124	-21.3689	-263.3583	1.0642	-24.4968	-260.6558
4.256	8.306	-23.0183	-263.0776	-0.1598	-2.9482	15.5593	-21.5976	-264.2688	1.0526	-24.4389	-261.8865
4.272	8.1251	-23.1526	-263.0751	-0.1519	-2.9163	14.5829	-21.6724	-264.0893	1.6673	-24.6329	-262.061
4.288	7.7116	-23.1879	-263.7199	-0.1163	-2.9653	14.3309	-22.0086	-264.5054	1.0923	-24.3672	-262.9344

Rockan3

time	pos(x)	pos(y)	pos(z)	el	az	x1	y1	z1	x2	y2	z2
0	0	0	0	0.3707	-1.3877	-0.651	3.515	1.3893	0.651	-3.515	-1.3893
0.016	0.0457	0.4847	-1.5695	0.3013	-1.4301	-0.3863	3.5357	-0.612	0.4777	-2.5663	-2.527
0.032	-0.2352	-0.2288	-5.1015	0.6249	-1.2618	-1.1413	2.6101	-2.9517	0.6709	-3.0677	-7.2513
0.048	-0.4713	-0.8866	-8.1854	0.633	-1.3041	-1.2098	1.8161	-6.1297	0.2672	-3.5893	-10.2411
0.064	-0.9864	-0.8634	-7.2527	0.2333	-1.3977	-1.5036	2.0952	-6.5389	-0.4692	-3.8219	-7.9664
0.08	-0.3075	-1.2847	-9.617	0.0951	-1.6738	0.0202	1.8864	-9.3129	-0.6351	-4.4558	-9.9212
0.096	-0.8704	-1.8094	-11.1261	0.2516	-1.5082	-1.0778	1.4966	-10.2747	-0.6631	-5.1154	-11.9775
0.112	0.4209	-1.773	-12.0269	0.1338	-1.3121	-0.235	0.7055	-11.6818	1.0768	-4.2514	-12.3719
0.128	1.2038	-2.7289	-13.845	-0.2744	-1.2601	0.4744	-0.4573	-14.5168	1.9332	-5.0006	-13.1733
0.144	1.2351	-2.9027	-14.4237	-0.5513	-1.0039	0.0173	-0.9898	-15.8181	2.4529	-4.8156	-13.0293
0.16	1.2176	-2.8934	-14.5895	-0.3191	-1.2148	0.4651	-0.8696	-15.3029	1.9701	-4.9172	-13.8762
0.176	1.3221	-3.3984	-15.1825	-0.4915	-1.1269	0.3792	-1.4156	-16.3578	2.2649	-5.3813	-14.0073
0.192	1.7846	-3.2715	-14.8524	-0.5614	-1.1305	0.8976	-1.3887	-16.1613	2.6717	-5.1544	-13.5434
0.208	1.4919	-3.5017	-15.3453	-0.5518	-1.1695	0.559	-1.303	-16.8156	2.4248	-5.7004	-13.875
0.224	1.8432	-4.1088	-16.2698	-0.5512	-0.9878	0.5415	-2.1347	-17.7234	3.145	-6.0828	-14.8163
0.24	2.0756	-3.6869	-16.0186	-0.7546	-1.1075	1.1629	-1.8598	-17.939	2.9883	-5.5141	-14.0982
0.256	1.6064	-4.1244	-15.8883	-0.7461	-1.2806	1.0104	-2.1286	-17.8136	2.2025	-6.1202	-13.963
0.272	2.1199	-4.0367	-16.0568	-0.7389	-1.1404	1.29	-2.2289	-17.8691	2.9497	-5.8446	-14.2446
0.288	1.7718	-4.4573	-16.8102	-0.7538	-1.1151	0.9321	-2.7438	-18.6013	2.6115	-6.1707	-15.019
0.304	1.7834	-4.5024	-17.1173	-0.568	-1.3329	1.2523	-2.3119	-18.5557	2.3146	-6.6929	-15.679
0.32	1.6332	-4.518	-16.9551	-0.6296	-1.3059	1.0806	-2.4805	-18.4932	2.1858	-6.5555	-15.417
0.336	2.2626	-4.5723	-17.8396	-0.9619	-1.4134	1.9797	-2.7906	-20.4268	2.5454	-6.3539	-15.2524
0.352	2.3715	-4.5049	-18.3999	-1.0972	-1.2535	1.8465	-2.9063	-21.6832	2.8965	-6.1034	-15.1166

Rock3

time	pos(x)	pos(y)	pos(z)	el	az	x1	y1	z1	x2	y2	z2
0.368	1.8162	-4.7393	-19.5075	-1.1245	-1.4287	1.5913	-3.1673	-22.826	2.041	-6.3112	-16.1889
0.384	2.1161	-5.1999	-20.6253	-1.206	-1.5637	2.1052	-3.6537	-24.6746	2.1271	-6.7462	-16.576
0.4	2.4755	-5.0596	-20.5601	-1.208	-1.3819	2.202	-3.6295	-24.396	2.7489	-6.4897	-16.7242
0.416	1.8338	-5.2304	-21.2826	-1.3157	-1.6377	1.9106	-4.0838	-25.6889	1.757	-6.377	-16.8764
0.432	2.5498	-5.256	-22.0497	-1.2312	-1.4263	2.3393	-3.81	-26.1863	2.7602	-6.702	-17.9131
0.448	1.9235	-4.766	-22.3085	-1.2597	-1.5856	1.9436	-3.4057	-26.5403	1.9034	-6.1264	-18.0767
0.464	2.1842	-5.2334	-23.2711	-1.2737	-1.0612	1.5075	-4.0225	-27.802	2.861	-6.4443	-18.7403
0.48	2.0305	-5.5415	-24.1277	-1.2186	-1.2249	1.4746	-3.999	-28.5891	2.5865	-7.084	-19.6663
0.496	1.9111	-5.2624	-24.8824	-1.2405	-1.2182	1.3889	-3.8434	-29.292	2.4333	-6.6814	-20.4729
0.512	2.3542	-5.5122	-25.6397	-1.2218	-1.3492	2.0114	-3.9908	-29.9251	2.6969	-7.0335	-21.3542
0.528	2.2364	-5.4901	-26.3794	-1.1946	-1.3265	1.8394	-3.8976	-30.5349	2.6334	-7.0827	-22.2239
0.544	2.4883	-5.4996	-27.2202	-1.2377	-1.2921	2.0756	-4.0573	-31.556	2.901	-6.9418	-22.8843
0.56	2.3786	-5.7975	-28.1614	-1.2438	-1.1564	1.804	-4.4912	-32.3686	2.9532	-7.1038	-23.9541
0.576	2.1573	-5.4573	-29.0964	-1.0578	-1.1054	1.2266	-3.604	-32.7785	3.088	-7.3106	-25.4143
0.592	2.2656	-5.5763	-30.1815	-0.9592	-1.1205	1.2979	-3.5745	-33.3517	3.2333	-7.578	-27.0112
0.608	2.1323	-5.5181	-30.7035	-0.9313	-1.2177	1.3743	-3.4613	-33.651	2.8903	-7.5749	-27.756
0.624	1.8611	-5.883	-31.8787	-0.9631	-1.1407	0.9548	-3.9074	-35.0039	2.7674	-7.8585	-28.7536
0.64	1.7938	-5.7826	-32.6474	-0.8576	-1.0471	0.6008	-3.7169	-35.4047	2.9868	-7.8484	-29.8901
0.656	1.3584	-5.924	-33.97	-0.6877	-1.1651	0.3752	-3.6347	-36.0167	2.3416	-8.2133	-31.9234
0.672	1.3765	-6.0845	-35.0121	-0.7297	-1.1708	0.5848	-4.212	-36.8305	2.1682	-7.9571	-33.1937
0.688	1.4394	-6.1729	-35.7851	-0.4228	-1.1187	0.281	-3.7876	-36.9781	2.5979	-8.5582	-34.5921
0.704	1.2743	-6.2026	-36.4043	-0.1713	-1.0301	-0.1512	-3.8286	-36.8833	2.6997	-8.5766	-35.9252
0.72	2.1539	-6.121	-37.1939	-0.1097	-1.1266	0.9275	-3.5438	-37.5083	3.3803	-8.6982	-36.8795
0.736	1.3947	-5.5033	-37.0455	0.1103	-1.0893	-0.0834	-2.6747	-36.692	2.8728	-8.3319	-37.3989
0.752	1.7119	-5.5758	-38.0064	0.1628	-1.1034	0.2621	-2.7033	-37.478	3.1616	-8.4483	-38.5347
0.768	2.0138	-5.5729	-39.1251	0.3197	-1.2018	0.749	-2.3024	-37.9643	3.2787	-8.8434	-40.2859
0.784	1.7424	-5.7902	-39.684	0.3007	-0.9693	-0.1598	-3.019	-38.6417	3.6446	-8.5615	-40.7264
0.8	1.9917	-6.2057	-41.0292	0.3592	-1.1534	0.8302	-3.5864	-39.9534	3.1532	-8.8249	-42.105
0.816	1.7362	-6.3722	-41.7237	0.4285	-1.0656	0.0355	-3.2974	-40.1186	3.4368	-9.4469	-43.3288
0.832	1.561	-6.3691	-42.3588	0.385	-1.0262	-0.3918	-3.1453	-40.8315	3.5137	-9.5928	-43.8861
0.848	0.7249	-5.9614	-42.8269	0.3755	-0.756	-2.1699	-3.2322	-41.2584	3.6196	-8.6906	-44.3955
0.864	1.1375	-5.7101	-43.3428	0.469	-0.7902	-1.8374	-2.7062	-41.2007	4.1124	-8.714	-45.4849
0.88	1.2838	-5.8811	-43.9971	0.4478	-0.7004	-1.8253	-3.2601	-42.0439	4.3929	-8.5022	-45.9502
0.896	2.266	-6.2298	-44.7369	0.4276	-0.7532	-0.8154	-3.341	-42.8122	5.3473	-9.1185	-46.6617
0.912	2.1283	-5.679	-45.4315	0.5587	-0.7643	-0.9395	-2.738	-42.7747	5.1961	-8.62	-48.0883
0.928	2.4036	-5.916	-45.9039	0.5445	-0.7361	-0.7291	-3.0777	-43.344	5.5363	-8.7543	-48.4637
0.944	2.2798	-5.6955	-46.1583	0.4912	-0.7217	-1.1404	-2.6854	-43.7213	5.7	-8.7056	-48.5953
0.96	2.0199	-6.143	-47.0635	0.4413	-0.6441	-1.804	-3.2717	-44.8046	5.8439	-9.0143	-49.3224
0.976	1.8617	-6.5244	-48.0166	0.4341	-0.5775	-2.7566	-3.5151	-45.4612	6.4801	-9.5336	-50.572
0.992	1.9658	-6.3375	-48.0545	0.4017	-0.6147	-2.4125	-3.2471	-45.7778	6.344	-9.428	-50.3312
1.008	2.2832	-5.8206	-48.598	0.4612	-0.6291	-1.9463	-2.7424	-45.9983	6.5128	-8.8988	-51.1978
1.024	2.354	-5.3227	-49.1944	0.4711	-0.5561	-2.1359	-2.532	-46.5014	6.8439	-8.1133	-51.8874
1.04	2.4951	-6.1514	-50.3035	0.4314	-0.602	-1.3335	-3.5211	-48.1655	6.3236	-8.7817	-52.4416
1.056	2.7976	-6.065	-51.064	0.3532	-0.5422	-1.1998	-3.6566	-49.3437	6.795	-8.4733	-52.7844
1.072	3.2817	-5.3271	-50.5683	0.6839	-0.7779	-0.2891	-1.8092	-46.4825	6.8525	-8.845	-54.6541
1.088	2.8237	-5.6992	-51.7166	0.6689	-0.7731	-0.6478	-2.3121	-47.8823	6.2953	-9.0863	-55.5508
1.104	3.2508	-5.1386	-51.3996	0.6155	-0.8098	-0.3541	-1.3531	-47.7029	6.8556	-8.9241	-55.0963
1.12	2.8327	-4.9078	-52.0617	0.5795	-0.7074	-1.3805	-1.3052	-48.4337	7.0459	-8.5105	-55.6898
1.136	3.0217	-4.7142	-52.4539	0.538	-0.6754	-1.6915	-0.9382	-48.8503	7.7349	-8.4901	-56.0575
1.152	2.7558	-4.948	-53.1564	0.5756	-0.7261	-1.1866	-1.4478	-49.7358	6.6982	-8.4481	-56.577
1.168	3.5032	-4.7101	-53.2502	0.5567	-0.728	-0.7279	-0.9392	-49.7231	7.7342	-8.481	-56.7773
1.184	3.6674	-4.6815	-53.2076	0.494	-0.756	-0.5071	-0.7452	-50.1174	7.8419	-8.6179	-56.2979
1.2	3.9228	-5.2463	-54.8062	0.4122	-0.6175	-0.2999	-2.2476	-52.5417	8.1455	-8.245	-57.0707
1.216	3.8585	-4.5208	-54.9611	0.4193	-0.6043	-0.5451	-1.4802	-52.5756	8.2621	-7.5614	-57.3466
1.232	3.2195	-4.7214	-55.9641	0.3465	-0.5282	-1.6772	-1.864	-53.9173	8.1161	-7.5787	-58.0109
1.248	3.6424	-6.5361	-57.7598	-0.0895	-0.2219	-0.9504	-5.5001	-58.1824	8.2352	-7.5721	-57.3373
1.264	3.5343	-5.9401	-58.0691	-0.0432	-0.2519	-0.7795	-4.8299	-58.2619	7.8482	-7.0502	-57.8764
1.28	4.1089	-6.4415	-59.4033	-0.1083	-0.1225	-0.399	-5.8864	-59.8971	8.6168	-6.9965	-58.9095
1.296	3.7749	-6.4409	-59.6935	-0.23	-0.1139	-1.7765	-5.8061	-61.0019	9.3263	-7.0757	-58.3851
1.312	5.026	-6.7372	-59.7168	-0.2299	-0.1126	0.2017	-6.1916	-60.853	9.8504	-7.2827	-58.5806
1.328	4.1403	-6.3468	-60.3107	-0.2887	-0.0969	-0.6659	-5.8794	-61.745	8.9466	-6.8142	-58.8764
1.344	4.8113	-6.7295	-60.7558	-0.3454	0.0647	-0.3608	-7.0644	-62.6207	9.9833	-6.3946	-58.8908
1.36	4.9658	-6.6012	-61.1206	-0.3375	0.0677	-0.0379	-6.9405	-62.8806	9.9696	-6.2619	-59.3607
1.376	5.2888	-6.2494	-61.9862	-0.3939	0.1136	0.1371	-6.8372	-64.1411	10.4404	-5.6616	-59.8313
1.392	4.3121	-6.2108	-62.5269	-0.4121	0.1243	-0.8875	-6.8606	-64.8175	9.5116	-5.561	-60.2363
1.408	5.1723	-6.1288	-62.9498	-0.4926	0.1087	0.4426	-6.6448	-65.5032	9.9019	-5.6127	-60.3965

Rock3

time	pos(x)	pos(y)	pos(z)	el	az	x1	y1	z1	x2	y2	z2
1.424	4.2702	-6.1096	-63.7942	-0.5063	0.1662	-0.5832	-6.9238	-66.5228	9.1236	-5.2955	-61.0656
1.44	4.9078	-6.2673	-64.6166	-0.4707	0.1463	-0.1561	-7.0135	-67.2212	9.9718	-5.5212	-62.012
1.456	3.9284	-5.8421	-64.9398	-0.4833	0.1866	-2.0527	-6.9714	-68.1342	9.9095	-4.7129	-61.7454
1.472	3.5727	-6.3973	-65.8454	-0.5502	0.2234	-1.7457	-7.6055	-69.191	8.891	-5.1892	-62.4998
1.488	3.5812	-6.2961	-66.6389	-0.5187	0.2879	-1.869	-7.9102	-69.8838	9.0314	-4.6819	-63.3941
1.504	4.2766	-6.574	-67.4177	-0.5226	0.3639	-1.553	-8.7943	-71.0112	10.1063	-4.3537	-63.8242
1.52	4.3508	-6.5109	-67.9064	-0.5949	0.4129	-0.0349	-8.4321	-71.1467	8.7365	-4.5898	-64.6661
1.536	3.6006	-6.3222	-68.4727	-0.5786	0.4063	-1.255	-8.4112	-71.9252	8.4562	-4.2332	-65.0203
1.552	4.2181	-6.3386	-69.2281	-0.5421	0.3609	-1.075	-8.3365	-72.6352	9.5112	-4.3407	-65.821
1.568	1.6683	-6.0949	-70.0739	-0.5422	0.4759	-3.4586	-8.7376	-73.549	6.7953	-3.4522	-66.5988
1.584	1.7232	-5.8918	-71.0091	-0.5453	0.488	-3.5306	-8.681	-74.6176	6.977	-3.1026	-67.4006
1.6	1.9555	-6.0653	-71.5767	-0.485	0.3815	-3.9205	-8.4224	-74.9133	7.8315	-3.7081	-68.24
1.616	2.159	-6.5245	-73.084	-0.4816	0.4773	-3.0858	-9.2372	-76.1701	7.4037	-3.8117	-69.998
1.632	2.2508	-6.6535	-73.5018	-0.4781	0.4932	-2.9125	-9.4291	-76.5397	7.4141	-3.8779	-70.4638
1.648	2.2692	-6.8232	-74.3993	-0.4381	0.4363	-3.2216	-9.3835	-77.2373	7.7601	-4.2629	-71.5613
1.664	1.5086	-7.4813	-75.1141	-0.4384	0.4626	-3.8176	-10.1372	-77.9046	6.8348	-4.8254	-72.3235
1.68	1.6905	-6.7206	-75.5501	-0.422	0.4889	-3.6196	-9.5458	-78.2504	7.0005	-3.8955	-72.8498
1.696	2.0918	-6.8082	-76.5751	-0.4157	0.5001	-3.0664	-9.6265	-79.17	7.25	-3.9898	-73.9802
1.712	1.0037	-7.0318	-77.1811	-0.3647	0.554	-3.839	-10.0278	-79.3553	5.8464	-4.0358	-75.0068
1.728	1.1055	-7.8729	-77.8153	-0.3927	0.6713	-3.6463	-11.6478	-80.3291	5.8572	-4.0981	-75.3015
1.744	2.1924	-8.0314	-78.93	-0.3136	0.613	-2.6535	-11.4402	-80.8515	7.0383	-4.6226	-77.0085
1.76	1.3201	-7.8098	-79.5775	-0.3533	0.7497	-2.7347	-11.5853	-81.6206	5.375	-4.0343	-77.5343
1.776	1.1871	-7.9654	-80.2062	-0.4189	0.8583	-2.2803	-11.9793	-82.5681	4.6545	-3.9515	-77.8444
1.792	0.767	-7.9046	-80.7059	-0.4412	0.9405	-2.1012	-11.8363	-83.004	3.6352	-3.9728	-78.4077
1.808	0.7421	-8.0722	-82.0592	-0.3982	0.9089	-2.3579	-12.051	-84.1808	3.8421	-4.0933	-79.9376
1.824	0.8175	-8.4734	-83.1939	-0.3331	0.844	-2.3218	-12.0042	-84.8284	3.9567	-4.9426	-81.5593
1.84	0.6975	-8.5341	-83.6124	-0.3718	0.9072	-2.3023	-12.3709	-85.5114	3.6972	-4.6974	-81.7133
1.856	0.5776	-8.713	-84.6233	-0.3248	0.9464	-2.3489	-12.7743	-86.3087	3.5042	-4.6518	-82.938
1.872	0.5639	-8.5933	-84.7817	-0.3516	1.0319	-1.9577	-12.811	-86.5844	3.0856	-4.3757	-82.979
1.888	0.5561	-8.0718	-85.1857	-0.352	0.9957	-2.4214	-12.6656	-87.1967	3.5336	-3.4781	-83.1748
1.904	0.2757	-8.8668	-86.2277	-0.4431	1.0812	-2.1905	-13.4948	-88.7168	2.7418	-4.2387	-83.7387
1.92	0.3326	-9.7209	-86.9918	-0.4041	1.1274	-1.7922	-14.1942	-89.1098	2.4574	-5.2475	-84.8738
1.936	-0.3913	-9.4974	-87.4452	-0.4631	1.2463	-1.8506	-13.8348	-89.7301	1.068	-5.16	-85.1604
1.952	-0.7339	-10.0508	-88.662	-0.3739	1.4256	-1.4349	-14.8447	-90.5627	-0.0329	-5.2569	-86.7613
1.968	-0.9164	-9.9072	-89.073	-0.4341	1.5527	-0.9984	-14.4473	-91.1779	-0.8343	-5.3672	-86.9681
1.984	-1.0061	-9.9492	-90.3759	-0.4344	1.5634	-1.0385	-14.3499	-92.4174	-0.9736	-5.5485	-88.3343
2	-1.0762	-10.1124	-90.4585	-0.5059	1.6185	-0.8316	-15.2402	-93.3023	-1.3208	-4.9846	-87.6148
2.016	-0.6652	-10.1484	-91.634	-0.4684	1.551	-0.7513	-14.51	-93.8412	-0.579	-5.7868	-89.4267
2.032	-0.6779	-10.4302	-92.2261	-0.4449	1.6224	-0.4512	-14.8177	-94.3208	-0.9046	-6.0428	-90.1314
2.048	-0.4579	-10.4254	-92.7521	-0.4326	1.6027	-0.3222	-14.6827	-94.7188	-0.5936	-6.1681	-90.7853
2.064	-0.0662	-10.7055	-93.7331	-0.4143	1.6495	0.2828	-15.1334	-95.6861	-0.4152	-6.2776	-91.7801
2.08	-0.0716	-10.309	-93.74	-0.4069	1.7247	0.639	-14.8899	-95.7378	-0.7821	-5.7281	-91.7421
2.096	0.3782	-10.1645	-94.5523	-0.4214	1.7027	0.9947	-14.8125	-96.6541	-0.2382	-5.5165	-92.4504
2.112	-0.111	-10.3196	-95.4574	-0.3566	1.7429	0.6727	-14.8293	-97.1624	-0.8947	-5.8098	-93.7523
2.128	0.1372	-10.7065	-96.1696	-0.5044	1.8296	1.261	-14.9514	-98.5934	-0.9866	-6.4616	-93.7458
2.144	0.5775	-10.6265	-96.742	-0.483	1.8328	1.3934	-13.6688	-98.3939	-0.2384	-7.5842	-95.0901
2.16	0.7464	-10.1911	-96.8324	-0.5792	1.9157	1.6932	-12.8262	-98.6636	-0.2003	-7.5561	-95.0013
2.176	1.0163	-10.9208	-98.304	-0.5523	1.9996	2.0033	-13.0798	-99.7669	0.0293	-8.7618	-96.8411
2.192	0.6374	-10.8033	-98.9829	-0.5482	2.1867	2.1348	-12.919	-100.5655	-0.8599	-8.6876	-97.4003
2.208	1.1512	-10.516	-99.3474	-0.5527	2.0183	2.2985	-12.9067	-100.9829	0.0038	-8.1252	-97.7119
2.224	1.4628	-11.1546	-100.2166	-0.5382	2.0523	2.7344	-13.588	-101.8559	0.1911	-8.7211	-98.5774
2.24	1.3405	-10.9684	-100.4273	-0.5222	2.1267	2.8667	-13.4253	-102.0918	-0.1856	-8.5116	-98.7628
2.256	1.5285	-12.0492	-102.0068	-0.5388	2.137	2.9321	-14.2575	-103.5712	0.1249	-9.8408	-100.4425
2.272	1.1231	-11.5075	-102.2094	-0.5224	2.3983	3.5381	-13.7272	-104.0979	-1.292	-9.2877	-100.3209
2.288	0.998	-12.1079	-103.096	-0.4872	2.466	3.8115	-14.3627	-105.006	-1.8155	-9.8532	-101.1861
2.304	1.0869	-11.7447	-103.2124	-0.5165	2.4336	3.7765	-14.0471	-105.2233	-1.6027	-9.4423	-101.2015
2.32	1.1447	-11.6176	-104.002	-0.4853	2.2991	4.3648	-15.2279	-106.5534	-2.0753	-8.0072	-101.4507
2.336	1.2647	-12.3414	-105.2681	-0.4693	2.3784	4.6095	-15.5412	-107.6156	-2.0801	-9.1416	-102.9207
2.352	1.2938	-12.7082	-105.9125	-0.4708	2.3697	4.4372	-15.7675	-108.1449	-1.8495	-9.649	-103.6802
2.368	1.4696	-12.5759	-106.3213	-0.4913	2.408	5.0087	-15.766	-108.8707	-2.0695	-9.3858	-103.7718
2.384	1.2151	-12.4892	-107.0468	-0.46	2.4976	4.9094	-15.2627	-109.3354	-2.4792	-9.7157	-104.7582
2.4	1.5364	-12.9212	-108.0921	-0.4441	2.5578	5.9407	-15.8309	-110.6039	-2.868	-10.0114	-105.5803
2.416	2.1362	-13.3871	-108.747	-0.4438	2.536	5.8899	-15.9863	-110.9177	-1.6175	-10.7879	-106.5762
2.432	2.5811	-13.3034	-109.5258	-0.4321	2.5596	6.1891	-15.6777	-111.5177	-1.0269	-10.9291	-107.5339
2.448	2.1796	-13.4001	-110.1153	-0.4108	2.664	6.2093	-15.4854	-112.0917	-1.85	-11.3147	-108.1389
2.464	2.8867	-13.6565	-111.0231	-0.3866	2.6714	6.2404	-15.361	-112.5547	-0.4671	-11.952	-109.4914

Rock3

time	pos(x)	pos(y)	pos(z)	el	az	x1	y1	z1	x2	y2	z2
2.48	2.7809	-14.7248	-112.4498	-0.4499	2.4987	6.4754	-17.4924	-114.679	-0.9137	-11.9573	-110.2207
2.496	2.3666	-13.7675	-112.2514	-0.4282	2.4611	6.2123	-16.8805	-114.51	-1.4791	-10.6544	-109.9929
2.512	2.8444	-13.8385	-112.6914	-0.3554	2.7173	7.2036	-15.8076	-114.4669	-1.5147	-11.8695	-110.9158
2.528	2.8727	-14.6961	-113.9419	-0.4353	2.5819	7.2374	-17.4304	-116.3372	-1.4921	-11.9618	-111.5465
2.544	2.637	-14.852	-115.1714	-0.3672	2.6105	6.9646	-17.394	-117.1018	-1.6906	-12.31	-113.241
2.56	3.1602	-13.7432	-114.3514	-0.3611	2.7367	7.5543	-15.6262	-116.1568	-1.234	-11.8602	-112.546
2.576	4.2941	-15.2225	-116.0615	-0.3657	2.6967	8.234	-17.1007	-117.7326	0.3543	-13.3443	-114.3904
2.592	3.2525	-14.4928	-116.2054	-0.3467	2.6417	7.5224	-16.8246	-117.963	-1.0173	-12.1609	-114.4479
2.608	3.2132	-14.4922	-117.177	-0.2986	2.7748	7.2031	-16.025	-118.4927	-0.7767	-12.9594	-115.8614
2.624	4.0002	-14.9323	-118.4676	-0.3521	2.6549	8.8236	-17.4844	-120.4725	-0.8232	-12.3802	-116.4627
2.64	3.2442	-14.2911	-118.329	-0.2895	2.7194	8.2656	-16.5465	-119.9685	-1.7771	-12.0357	-116.6895
2.656	3.7571	-14.3892	-119.3359	-0.3001	2.7768	8.7439	-16.2937	-120.9877	-1.2297	-12.4846	-117.6841
2.672	2.9556	-15.236	-120.8696	-0.2634	2.7955	7.642	-16.9259	-122.2132	-1.7309	-13.5461	-119.5261
2.688	4.463	-15.2646	-121.9659	-0.2139	2.7134	8.6197	-17.1616	-122.9584	0.3064	-13.3675	-120.9735
2.704	4.4521	-15.0903	-121.8958	-0.1325	2.8686	9.1695	-16.4109	-122.5485	-0.2653	-13.7698	-121.2431
2.72	4.8028	-16.1186	-123.1905	-0.1824	2.7917	9.5418	-17.8481	-124.1208	0.0637	-14.3891	-122.2602
2.736	5.1164	-15.2534	-123.9858	-0.1686	2.7999	10.1963	-17.06	-124.9038	0.0366	-13.4468	-123.0678
2.752	5.2908	-15.614	-124.4029	-0.086	2.8495	10.1993	-17.0898	-124.8447	0.3824	-14.1381	-123.9612
2.768	5.0582	-15.5717	-125.7139	-0.1797	2.6987	10.1994	-18.0102	-126.7476	-0.083	-13.1332	-124.6802
2.784	5.4768	-15.6438	-126.5389	-0.1861	2.7864	10.0987	-17.3584	-127.4668	0.8548	-13.9293	-125.6109
2.8	6.0355	-15.8626	-126.6218	-0.2202	2.7524	11.4883	-18.099	-127.9407	0.5826	-13.6261	-125.3028
2.816	5.7811	-15.8144	-127.0051	-0.2167	2.8319	11.4144	-17.6168	-128.3072	0.1477	-14.0119	-125.703
2.832	5.7352	-15.9293	-128.4516	-0.1932	2.7217	11.2525	-18.3925	-129.6337	0.218	-13.466	-127.2694
2.848	6.2826	-16.6789	-129.1039	-0.1774	2.7365	11.5741	-18.948	-130.1362	0.9912	-14.4099	-128.0716
2.864	6.5024	-16.7131	-130.5732	-0.1348	2.8168	11.9594	-18.5508	-131.354	1.0454	-14.8754	-129.7925
2.88	6.9258	-17.0565	-131.2064	-0.2396	2.7899	12.619	-19.1453	-132.6878	1.2326	-14.9676	-129.725
2.896	6.5479	-16.6001	-131.5913	-0.1528	2.7918	12.7815	-18.874	-132.6132	0.3143	-14.3261	-130.5694
2.912	7.3889	-16.824	-132.4785	-0.1931	2.7995	12.6656	-18.7031	-133.5735	2.1121	-14.9449	-131.3835
2.928	7.4316	-16.8084	-132.9295	-0.2393	2.7476	12.934	-19.0956	-134.3831	1.9292	-14.5212	-131.4759
2.944	7.6807	-16.8743	-133.0957	-0.2714	2.6923	12.8788	-19.3807	-134.7016	2.4826	-14.3679	-131.4898
2.96	7.4328	-16.8258	-133.6879	-0.2806	2.7769	13.2226	-19.0362	-135.4737	1.643	-14.6153	-131.9021
2.976	6.8655	-16.8473	-134.4802	-0.3952	2.6633	11.2602	-19.1257	-136.545	2.4708	-14.5689	-132.4153
2.992	6.3921	-16.5815	-135.1863	-0.4125	2.689	10.6033	-18.6294	-137.2352	2.1809	-14.5336	-133.1374
3.008	6.8614	-16.6629	-136.1922	-0.421	2.5873	10.2179	-18.7406	-137.9597	3.5049	-14.5853	-134.4248
3.024	7.3181	-17.0649	-136.8544	-0.4725	2.6424	10.376	-18.7322	-138.6348	4.2603	-15.3975	-135.0741
3.04	7.3649	-17.0126	-137.4107	-0.4881	2.5459	10.3596	-19.0425	-139.3316	4.3703	-14.9828	-135.4899
3.056	7.1878	-16.677	-137.8944	-0.545	2.5241	10.1156	-18.756	-140.0716	4.2599	-14.598	-135.7172
3.072	7.7718	-16.6233	-138.874	-0.5714	2.4653	10.4063	-18.7375	-141.0457	5.1372	-14.5091	-136.7023
3.088	8.1207	-16.9683	-139.2339	-0.6177	2.5079	10.6847	-18.8523	-141.4942	5.5567	-15.0843	-136.9737
3.104	7.7272	-16.5648	-139.4891	-0.6755	2.2913	10.2794	-19.472	-142.5889	5.1751	-13.6576	-136.3893
3.12	8.0035	-16.5722	-140.2874	-0.6103	2.4583	11.3686	-19.312	-143.322	4.6384	-13.8324	-137.2527
3.136	8.1648	-16.5827	-140.6269	-0.681	2.4103	11.2412	-19.3431	-143.9763	5.0884	-13.8224	-137.2775
3.152	8.7212	-16.4718	-141.3787	-0.7112	2.3004	11.5038	-19.5838	-144.9756	5.9386	-13.3598	-137.7818
3.168	8.8035	-15.7701	-141.8542	-0.747	2.2892	11.8406	-19.244	-146.1271	5.7664	-12.2962	-137.5813
3.184	9.0498	-16.7295	-143.0749	-0.7701	2.2263	11.5431	-19.9719	-147.0418	6.5566	-13.4872	-139.1081
3.2	9.1603	-17.6717	-144.0329	-0.748	2.1996	11.7366	-21.2137	-148.0969	6.584	-14.1296	-139.969
3.216	8.7618	-17.2128	-144.7226	-0.7373	2.118	11.2293	-21.2627	-149.0296	6.2943	-13.1628	-140.4157
3.232	9.3899	-16.9508	-145.7064	-0.7812	2.218	12.1834	-20.6468	-150.3006	6.5963	-13.2548	-141.1122
3.248	9.7553	-16.2418	-146.0585	-0.7208	2.1294	12.4634	-20.5745	-150.547	7.0472	-11.909	-141.57
3.264	9.2738	-16.457	-146.7106	-0.7222	2.0007	11.4952	-21.3015	-151.4061	7.0524	-11.6125	-142.0152
3.28	10.3242	-16.5525	-147.4024	-0.7138	1.9086	12.2503	-22.0357	-152.4366	8.3982	-11.0692	-142.3682
3.296	10.3592	-16.6897	-148.5196	-0.7312	1.917	12.2754	-22.0016	-153.5854	8.443	-11.3778	-143.4537
3.312	10.6835	-17.1844	-149.5029	-0.6955	1.8322	12.3303	-23.3405	-154.8213	9.0366	-11.0284	-144.1845
3.328	10.5752	-16.7925	-150.0685	-0.732	1.871	12.2765	-22.2883	-155.2375	8.8739	-11.2968	-144.8995
3.344	10.7563	-16.8394	-151.3932	-0.7067	1.8426	12.2807	-22.3088	-156.2406	9.232	-11.37	-146.5457
3.36	10.6981	-16.9594	-152.571	-0.6882	1.8133	12.1452	-22.809	-157.5257	9.2509	-11.1099	-147.6162
3.376	10.7858	-16.8488	-152.9639	-0.7175	1.8302	12.1948	-22.158	-157.7569	9.3768	-11.5397	-148.1709
3.392	11.2779	-18.1686	-153.9998	-0.6564	1.8017	12.5939	-23.766	-158.4289	9.9618	-12.5712	-149.5706
3.408	11.5828	-18.5684	-155.1095	-0.6081	1.6863	12.2887	-24.6516	-159.3722	10.877	-12.4852	-150.8468
3.424	11.2566	-18.4335	-155.9696	-0.5893	1.5755	11.2858	-24.6214	-160.1068	11.2274	-12.2455	-151.8324
3.44	11.1908	-18.7823	-156.4533	-0.6176	1.5458	11.0388	-24.861	-160.7722	11.3427	-12.7037	-152.1345
3.456	11.3659	-18.6603	-157.6801	-0.5317	1.5172	11.0359	-24.8139	-161.3045	11.6959	-12.5068	-154.0557
3.472	11.348	-18.9916	-158.5027	-0.4632	1.5179	11.0116	-25.3493	-161.6828	11.6843	-12.6339	-155.3226
3.488	11.0175	-18.943	-159.716	-0.4076	1.5324	10.7495	-25.9105	-162.7268	11.2855	-11.9755	-156.7051
3.504	11.3234	-19.0948	-160.3605	-0.4423	1.4639	10.6637	-25.2414	-163.2886	11.983	-12.9483	-157.4325
3.52	11.3315	-19.5269	-161.3609	-0.3628	1.4469	10.5082	-26.1361	-163.8893	12.1548	-12.9176	-158.8326

Rock3

time	pos(x)	pos(y)	pos(z)	el	az	x1	y1	z1	x2	y2	z2
3.536	11.4114	-19.8567	-162.522	-0.3122	1.4314	10.5179	-26.2272	-164.5982	12.305	-13.4862	-160.4459
3.552	10.8331	-20.6215	-163.0189	-0.2225	1.4156	9.8755	-26.7405	-164.4199	11.7908	-14.5025	-161.6179
3.568	10.435	-20.9631	-163.7386	-0.2272	1.4118	9.3611	-27.6599	-165.3064	11.5089	-14.2663	-162.1708
3.584	10.8588	-20.9027	-164.8598	-0.2107	1.4082	9.7422	-27.7099	-166.3352	11.9754	-14.0955	-163.3844
3.6	10.3366	-20.9293	-165.4793	-0.1239	1.4071	9.1249	-28.2645	-166.4052	11.5483	-13.5941	-164.5533
3.616	10.3246	-21.4635	-166.3898	-0.149	1.3379	8.9115	-27.4223	-167.3093	11.7378	-15.5047	-165.4703
3.632	10.0236	-21.0387	-166.8671	-0.1277	1.3325	8.5605	-27.0627	-167.6631	11.4867	-15.0147	-166.0712
3.648	10.4859	-21.7016	-167.7196	-0.0569	1.3094	8.7952	-28.0221	-168.0924	12.1767	-15.3812	-167.3468
3.664	10.1772	-22.1139	-168.921	-0.002	1.284	8.1973	-28.826	-168.9348	12.1571	-15.4018	-168.9072
3.68	10.3333	-22.1591	-169.7307	0.1905	1.121	8.2041	-26.5687	-168.7864	12.4625	-17.7496	-170.675
3.696	10.4674	-22.5007	-170.8496	0.2386	1.0897	8.2131	-26.8192	-169.6647	12.7217	-18.1822	-172.0345
3.712	10.3593	-23.0999	-171.1164	0.3329	0.9943	8.088	-26.5935	-169.6755	12.6307	-19.6063	-172.5573
3.728	10.4152	-23.3093	-171.67	0.3546	1.0539	8.3296	-26.9786	-170.1072	12.5009	-19.64	-173.2328
3.744	9.9205	-23.181	-172.7143	0.4464	0.9895	7.6019	-26.7098	-170.6933	12.239	-19.5522	-173.7353
3.76	10.3981	-23.874	-173.265	0.4207	0.9342	8.0932	-26.9916	-171.5301	12.703	-20.7563	-174.9999
3.776	9.9218	-23.8086	-174.0486	0.5798	0.7295	7.6041	-25.8806	-172.0126	12.2395	-21.7365	-176.0847
3.792	9.1005	-24.8081	-174.0382	0.4167	0.7032	5.5681	-27.8029	-171.9886	12.6329	-21.8133	-176.0879
3.808	9.4911	-24.5571	-175.2093	0.4809	0.7754	6.1784	-27.804	-172.7892	12.8038	-21.3103	-177.6295
3.824	9.2654	-24.0625	-175.8341	0.4803	0.7294	6.2659	-26.7433	-173.7384	12.2648	-21.3817	-177.9299
3.84	9.5495	-25.0981	-176.2104	0.4858	0.6981	6.6514	-27.5295	-174.2132	12.4475	-22.6666	-178.2077
3.856	9.6864	-25.2411	-177.2326	0.4503	0.8356	7.0303	-28.178	-175.3182	12.3424	-22.3041	-179.147
3.872	9.4299	-25.5442	-177.6827	0.4394	0.8956	6.9182	-28.681	-175.794	11.9415	-22.4073	-179.5714
3.888	9.5354	-25.312	-178.1357	0.5016	0.7213	6.9007	-27.629	-176.2118	12.17	-22.995	-180.0596
3.904	9.4419	-25.3926	-178.949	0.4199	0.8693	6.7992	-28.521	-177.1207	12.0847	-22.2642	-180.7772
3.92	9.3727	-25.2864	-179.2717	0.5219	0.8116	6.6706	-28.1342	-177.0143	12.0748	-22.4386	-181.5291
3.936	10.1034	-25.9655	-179.9949	0.4843	0.8376	7.5178	-28.8362	-177.9624	12.689	-23.0947	-182.0275
3.952	9.7978	-26.003	-180.4298	0.4436	0.8446	7.1649	-28.9679	-178.5455	12.4307	-23.038	-182.3141
3.968	9.7711	-26.618	-181.1485	0.5229	0.8056	7.1698	-29.3264	-178.9837	12.3724	-23.9096	-183.3133
3.984	9.6499	-27.1298	-181.5266	0.4711	0.8717	7.0666	-30.2023	-179.4821	12.2332	-24.0573	-183.5711
4	10.0338	-26.6762	-181.9629	0.4286	0.782	7.1725	-29.518	-180.1205	12.8952	-23.8344	-183.8054
4.016	9.3689	-27.0031	-182.4152	0.3553	0.494	5.5851	-29.0407	-180.8208	13.1528	-24.9655	-184.0097
4.032	8.6808	-26.866	-182.9734	0.3615	0.5888	5.4634	-29.0148	-181.5103	11.8982	-24.7172	-184.4366
4.048	8.6997	-26.6813	-183.7121	0.3868	0.8723	5.5259	-30.4605	-181.7019	11.8734	-22.902	-185.7223
4.064	9.0752	-27.198	-183.7654	0.3598	0.7905	6.0953	-30.2083	-182.1721	12.0551	-24.1877	-185.3586
4.08	8.9149	-26.5307	-184.9135	0.3426	0.8658	5.9671	-29.9953	-183.2908	11.8628	-23.0662	-186.5361
4.096	9.6351	-26.9342	-185.2504	0.3297	0.8219	6.6696	-30.1248	-183.7597	12.6006	-23.7437	-186.7411
4.112	9.0354	-26.7864	-185.9434	0.2934	1.0855	7.1376	-30.3848	-184.7144	10.9332	-23.1879	-187.1724
4.128	9.1739	-26.3641	-186.611	0.2493	1.0101	7.0081	-29.813	-185.574	11.3397	-22.9153	-187.648
4.144	9.3958	-26.386	-187.0041	0.2048	1.1913	7.8288	-30.3147	-186.1256	10.9628	-22.4573	-187.8826
4.16	9.3252	-26.9967	-187.27	0.1114	1.1265	7.597	-30.6272	-186.8203	11.0533	-23.3663	-187.7198
4.176	9.3822	-26.8126	-187.837	0.1045	1.2418	7.9415	-31.0328	-187.3693	10.823	-22.5923	-188.3046
4.192	9.5268	-26.209	-188.3965	0.0422	1.1591	7.8222	-30.1133	-188.2167	11.2315	-22.3046	-188.5763
4.208	9.833	-26.348	-188.9083	0.0353	1.1792	8.1732	-30.3677	-188.7548	11.4927	-22.3283	-189.0618
4.224	9.6733	-25.4252	-189.4992	0.0051	1.2667	8.1749	-30.2003	-189.4738	11.1716	-20.6501	-189.5246
4.24	9.7291	-25.3595	-190.1406	-0.0895	1.3313	8.3869	-30.8553	-190.6482	11.0712	-19.8637	-189.633
4.256	9.8013	-28.4509	-190.4528	-0.0959	1.3925	8.4401	-36.0045	-191.1911	11.1626	-20.8974	-189.7145
4.272	10.1534	-28.7692	-190.9299	-0.0464	1.4207	8.8338	-37.4976	-191.3402	11.4731	-20.0408	-190.5197
4.288	9.8869	-28.952	-191.5042	-0.0691	1.4102	8.6319	-36.7012	-192.0475	11.142	-21.2027	-190.9609
4.304	10.0842	-29.4741	-192.287	-0.1177	1.4216	8.9207	-37.2127	-193.2125	11.2477	-21.7356	-191.3615
4.32	10.4421	-28.7072	-192.6785	-0.2274	1.3664	9.0894	-35.2329	-194.2204	11.7947	-22.1815	-191.1366
4.336	10.5816	-27.9686	-192.9013	-0.155	1.4109	9.4202	-35.1683	-194.0406	11.743	-20.7689	-191.7619
4.352	10.6176	-27.3853	-193.7651	-0.1867	1.4421	9.7731	-33.9132	-195.0085	11.4621	-20.8574	-192.5216
4.368	10.8653	-27.4809	-194.6924	-0.2073	1.3793	9.798	-32.9856	-195.8718	11.9326	-21.9762	-193.513
4.384	10.6268	-27.6979	-194.9539	-0.2002	1.3728	9.4413	-33.6061	-196.1767	11.8123	-21.7897	-193.7312
4.4	10.7416	-28.6947	-195.4075	-0.2978	1.4143	9.6806	-35.4167	-197.4965	11.8026	-21.9727	-193.3184
4.416	10.1146	-28.121	-196.364	-0.4594	1.3615	8.826	-34.1878	-199.4319	11.4032	-22.0541	-193.2961
4.432	10.0681	-28.5103	-196.8714	-0.4075	1.3237	8.4831	-34.7947	-199.6693	11.653	-22.2259	-194.0734
4.448	9.8431	-29.3131	-197.3679	-0.4946	1.3288	8.3492	-35.3654	-200.73	11.3369	-23.2608	-194.0057
4.464	9.8532	-29.3136	-198.0739	-0.4795	1.3089	8.2386	-35.3367	-201.3164	11.4677	-23.2905	-194.8313
4.48	10.6334	-29.3102	-198.7482	-0.5275	1.2277	8.666	-34.8175	-202.1549	12.6008	-23.8029	-195.3415
4.496	10.346	-30.2835	-199.4381	-0.5467	1.3187	8.9406	-35.74	-202.8671	11.7514	-24.827	-196.0091
4.512	10.2928	-29.8775	-200.0958	-0.5066	1.3297	8.945	-35.3592	-203.2281	11.6405	-24.3959	-196.9634
4.528	9.7646	-29.6984	-201.1692	-0.5543	1.2942	8.2826	-34.9195	-204.5286	11.2466	-24.4773	-197.8099
4.544	9.9121	-30.0077	-201.6031	-0.6642	1.2639	8.5061	-34.4442	-205.2462	11.3182	-25.5713	-197.96
4.56	10.4911	-30.1822	-201.9869	-0.6643	1.257	9.0379	-34.6601	-205.6733	11.9444	-25.7043	-198.3005
4.576	10.2286	-30.5821	-202.9725	-0.5808	1.2995	8.7649	-35.844	-206.5569	11.6923	-25.3202	-199.3881

Rock3

time	pos(x)	pos(y)	pos(z)	el	az	x1	y1	z1	x2	y2	z2
4.592	10.0745	-30.9027	-203.9266	-0.7168	1.2276	8.529	-35.2277	-207.9286	11.6201	-26.5778	-199.9245
4.608	10.9334	-30.7976	-204.7747	-0.6248	1.0861	8.6271	-35.1776	-208.3448	13.2396	-26.4177	-201.2047
4.624	11.0518	-30.7792	-205.4311	-0.5985	1.0591	8.6181	-35.1128	-208.8202	13.4856	-26.4456	-202.0419
4.64	10.3586	-30.8625	-206.4243	-0.6344	1.1181	8.4002	-34.8889	-209.719	12.3171	-26.8362	-203.1296
4.656	10.4351	-31.4001	-207.4442	-0.6478	1.0669	8.2511	-35.361	-210.867	12.619	-27.4392	-204.0213
4.672	10.9559	-31.5232	-208.2676	-0.6538	0.9184	8.2381	-35.0807	-211.698	13.6737	-27.9658	-204.8371
4.688	10.8238	-32.003	-208.84	-0.6052	0.8423	7.6709	-35.5367	-212.1164	13.9767	-28.4693	-205.5636
4.704	10.4124	-32.2066	-210.1218	-0.5702	0.7883	6.8891	-35.7504	-213.3264	13.9357	-28.6628	-206.9172
4.72	11.2459	-32.5643	-210.5877	-0.5815	0.646	7.0881	-35.6991	-214.0103	15.4036	-29.4295	-207.1651
4.736	10.6955	-31.6333	-211.8716	-0.4463	0.6682	6.3287	-35.0802	-214.5333	15.0623	-28.1863	-209.2099
4.752	11.19	-32.3866	-212.3956	-0.5144	0.5461	7.0663	-34.8929	-215.1231	15.3138	-29.8804	-209.6681
4.768	10.5663	-32.0695	-213.3926	-0.4478	0.4978	6.1683	-34.4596	-215.7972	14.9643	-29.6795	-210.988
4.784	10.0049	-32.2181	-214.0125	-0.448	0.3947	5.3624	-34.1519	-216.4294	14.6473	-30.2844	-211.5957
4.8	10.1461	-32.4787	-214.9095	-0.4237	0.4733	5.7847	-34.712	-217.1194	14.5074	-30.2454	-212.6995
4.816	10.7169	-32.33	-215.7088	-0.3983	0.5431	6.7678	-34.7141	-217.6497	14.666	-29.9459	-213.768
4.832	10.4394	-32.2675	-216.4976	-0.2785	0.4286	6.3259	-34.1472	-217.7909	14.5529	-30.3879	-215.2043
4.848	10.4282	-32.4031	-216.9811	-0.2652	0.275	6.3253	-33.5609	-218.1392	14.5312	-31.2453	-215.823
4.864	10.1328	-33.8504	-217.1337	-0.0857	0.5616	5.6001	-36.7022	-217.5936	14.6655	-30.9985	-216.6738
4.88	9.9516	-32.6916	-218.7044	-0.2358	0.2782	5.3938	-33.9935	-219.8433	14.5093	-31.3897	-217.5655
4.896	10.425	-32.928	-219.3111	-0.1302	0.3575	6.1391	-34.5289	-219.91	14.7109	-31.3271	-218.7122
4.912	9.4864	-32.8903	-220.1493	-0.0955	0.2267	4.6909	-33.9963	-220.6205	14.2819	-31.7844	-219.6781
4.928	9.2115	-33.4517	-220.3053	-0.0772	0.2042	4.2503	-34.4791	-220.697	14.1727	-32.4244	-219.9137
4.944	9.2951	-33.3868	-220.9306	0.1002	0.1382	4.4855	-34.0556	-220.4423	14.1046	-32.7179	-221.4189
4.96	8.9466	-31.5991	-222.0865	0.0862	-0.076	4.5184	-31.2621	-221.7027	13.3748	-31.9361	-222.4704
4.976	8.8389	-31.7847	-222.7555	0.0341	-0.171	4.9419	-31.1115	-222.6205	12.736	-32.4578	-222.8906
4.992	9.0994	-31.8821	-223.4537	0.1029	-0.0836	4.8002	-31.5221	-223.0083	13.3986	-32.2422	-223.8992
5.008	8.7427	-31.3517	-224.505	0.1626	-0.166	4.7706	-30.6862	-223.8441	12.7149	-32.0173	-225.1659
5.024	8.4701	-31.8838	-224.6684	0.2531	-0.0899	4.8273	-31.5555	-223.7225	12.1129	-32.2122	-225.6143
5.04	8.3902	-32.0324	-225.5975	0.2519	-0.0894	4.3004	-31.6657	-224.5407	12.4799	-32.399	-226.6543
5.056	7.6937	-32.5938	-225.7967	0.3763	-0.026	3.5256	-32.4853	-224.1492	11.8619	-32.7022	-227.4443
5.072	7.0513	-32.3146	-226.9084	0.444	0.0483	2.5893	-32.5301	-224.7832	11.5133	-32.099	-228.0335
5.088	7.9311	-32.722	-227.0172	0.3197	-0.0645	3.3692	-32.4272	-225.5037	12.493	-33.0168	-229.5307
5.104	7.301	-32.1821	-227.7719	0.4243	-0.0532	3.0083	-31.9536	-225.8302	11.5938	-32.4107	-229.7137
5.12	6.8799	-32.5286	-228.0012	0.2494	-0.3121	2.5632	-31.1359	-226.8461	11.1967	-33.9212	-229.1562
5.136	6.6393	-32.1275	-228.4912	0.306	-0.2744	2.5793	-30.9846	-227.1587	10.6992	-33.2704	-229.8238
5.152	6.3351	-32.1054	-229.4375	0.2645	-0.4495	2.1285	-30.0759	-228.1728	10.5416	-34.1348	-230.7023
5.168	6.2952	-31.1506	-230.6391	0.3182	-0.3963	2.1712	-29.4251	-229.1667	10.4191	-32.8761	-232.1116
5.184	6.7541	-30.5913	-232.2049	0.3914	-0.384	2.7325	-28.9665	-230.4149	10.7757	-32.2161	-233.9948
5.2	7.2436	-30.3654	-232.8576	0.5437	-0.3992	3.9725	-28.9855	-230.7114	10.5147	-31.7453	-235.0038
5.216	7.2837	-30.1431	-233.6821	0.5594	-0.4532	4.2939	-28.687	-231.6001	10.2735	-31.5993	-235.7641
5.232	7.3197	-30.665	-233.9932	0.6184	-0.4006	4.324	-29.3961	-231.6785	10.3155	-31.9338	-236.308
5.248	5.6766	-30.6391	-233.4955	0.6975	-0.4889	3.3594	-29.4063	-231.2958	7.9938	-31.8718	-235.6952
5.264	6.2143	-30.5989	-234.473	0.5297	-0.6924	3.6825	-28.499	-232.547	8.7461	-32.6987	-236.3989
5.28	6.1936	-30.3821	-235.2291	0.5518	-0.7497	4.0082	-28.3474	-233.3911	8.3789	-32.4169	-237.0672
5.296	6.1088	-30.9834	-235.9515	0.5016	-0.9618	4.0127	-27.9781	-233.9423	8.2049	-33.9887	-237.9606
5.312	6.2045	-30.179	-237.5119	0.4897	-0.9821	4.1988	-27.1747	-235.5866	8.2102	-33.1833	-239.4373
5.328	6.2238	-29.6339	-238.1531	0.5154	-0.8702	3.9613	-26.9508	-236.1649	8.4863	-32.317	-240.1414
5.344	6.5851	-29.9734	-238.4421	0.5971	-0.9662	4.6982	-27.2422	-236.1853	8.472	-32.7045	-240.6988
5.36	5.9452	-30.0683	-239.4154	0.6082	-0.9826	4.19	-27.4367	-237.213	7.7005	-32.7	-241.6178
5.376	5.944	-29.6798	-239.8129	0.3957	-1.031	4.2493	-26.8515	-238.4354	7.6387	-32.5082	-241.1903
5.392	6.6859	-29.6149	-240.8392	0.4528	-0.8678	4.2532	-26.7443	-239.0085	9.1186	-32.4855	-242.67
5.408	6.6738	-29.9486	-241.3479	0.2802	-0.9897	4.3301	-26.3797	-240.1192	9.0176	-33.5175	-242.5766
5.424	6.1545	-29.4741	-241.9731	0.252	-1.0225	4.137	-26.1708	-240.9767	8.172	-32.7774	-242.9695
5.44	6.3239	-29.9541	-242.4224	0.1977	-0.9989	3.884	-26.1636	-241.5195	8.7639	-33.7446	-243.3254
5.456	6.4114	-29.0834	-243.8639	0.2326	-1.0583	4.1937	-25.142	-242.7926	8.629	-33.0248	-244.9353
5.472	6.6591	-28.8915	-244.6133	0.1653	-1.066	4.5616	-25.0954	-243.8896	8.7566	-32.6876	-245.337

Rockan4

time	pos(x)	pos(y)	pos(z)	el	az	x1	y1	z1	x2	y2	z2
0	0	0	0	0.3384	-0.5273	-5.1329	2.9886	2.0902	5.1329	-2.9886	-2.0902
0.016	0.2054	0.391	-2.4997	0.0934	-0.5011	-5.0895	3.2914	-1.9342	5.5003	-2.5095	-3.0652
0.032	-0.4508	1.378	-3.4128	0.5005	-0.4276	-6.8973	4.3159	0.462	5.9957	-1.56	-7.2875
0.048	-0.4302	1.0176	-6.0096	0.4884	-0.3801	-6.1567	3.3058	-2.7327	5.2963	-1.2706	-9.2864
0.064	-0.9312	-0.4944	-11.2511	0.683	-0.1227	-5.171	0.0285	-7.775	3.3085	-1.0173	-14.7272
0.08	-3.1448	-0.8728	-12.9671	0.6654	-0.1671	-7.388	-0.157	-9.5902	1.0984	-1.5886	-16.344

Rock4

time	pos(x)	pos(y)	pos(z)	el	az	x1	y1	z1	x2	y2	z2
0.096	-3.0908	-1.4712	-15.1544	0.4698	0.0366	-6.8923	-1.6102	-13.2232	0.7106	-1.3322	-17.0857
0.112	-2.1691	-2.5391	-18.2753	0.3528	0.0543	-6.5557	-2.7773	-16.6577	2.2174	-2.3009	-19.893
0.128	-1.7998	-2.9997	-20.4559	0.2658	0.0015	-5.9246	-3.0057	-19.333	2.325	-2.9936	-21.5788
0.144	-1.1088	-4.1674	-22.9996	0.3708	-0.0708	-5.342	-3.8674	-21.3499	3.1243	-4.4675	-24.6494
0.16	-1.967	-3.8958	-22.794	0.2436	-0.1374	-5.8144	-3.3638	-21.8287	1.8804	-4.4278	-23.7594
0.176	-0.3111	-3.9858	-23.3798	0.2455	-0.1093	-4.4645	-3.5298	-22.3326	3.8424	-4.4418	-24.4269
0.192	0.6984	-3.9603	-24.1066	0.3145	-0.1503	-3.9284	-3.2598	-22.5843	5.3251	-4.6609	-25.6288
0.208	1.0171	-3.8884	-24.5454	0.0907	-0.0434	-3.2794	-3.7017	-24.1541	5.3137	-4.0751	-24.9366
0.224	2.2414	-4.005	-25.1931	0.226	-0.1231	-2.4767	-3.4214	-24.1001	6.9595	-4.5885	-26.286
0.24	2.6417	-3.5316	-25.8566	0.1952	-0.0488	-2.2055	-3.295	-24.8971	7.4889	-3.7683	-26.8161
0.256	3.7455	-4.0761	-26.7821	0.1862	-0.0693	-0.7752	-3.7624	-25.9285	8.2663	-4.3898	-27.6356
0.272	4.7659	-4.1307	-28.2986	0.1917	-0.0575	-0.1325	-3.849	-27.3463	9.6644	-4.4124	-29.2509
0.288	5.4616	-4.4307	-29.1148	0.2088	-0.0908	0.5232	-3.9811	-28.0641	10.3999	-4.8804	-30.1655
0.304	6.4101	-4.7576	-29.9633	0.1958	-0.0508	1.3239	-4.499	-28.9533	11.4964	-5.0162	-30.9732
0.32	7.6078	-4.7376	-30.6869	0.1544	-0.0579	1.7607	-4.3988	-29.7752	13.4548	-5.0764	-31.5986
0.336	8.6295	-4.4988	-30.6967	0.1827	-0.1003	2.5702	-3.8892	-29.5716	14.6888	-5.1084	-31.8218
0.352	9.0709	-5.2358	-32.8395	-0.0225	-0.0164	3.6903	-5.1474	-32.9608	14.4515	-5.3242	-32.7182
0.368	10.1071	-5.5179	-33.119	-0.0573	-0.0131	5.029	-5.4513	-33.4102	15.1853	-5.5846	-32.8278
0.384	11.244	-5.089	-32.3978	-0.0256	-0.0293	5.8435	-4.9308	-32.5363	16.6444	-5.2473	-32.2593
0.4	11.8026	-5.5204	-33.7223	0.0464	-0.0638	6.6159	-5.1892	-33.4807	16.9893	-5.8516	-33.9638
0.416	13.4309	-4.8938	-32.6849	0.0955	-0.0835	7.3923	-4.3885	-32.1045	19.4696	-5.399	-33.2653
0.432	14.514	-5.2242	-34.3145	0.1526	-0.1308	8.2177	-4.396	-33.3376	20.8103	-6.0523	-35.2914
0.448	15.0698	-5.3626	-34.1953	0.1125	-0.1584	8.6742	-4.3407	-33.4634	21.4654	-6.3845	-34.9272
0.464	16.2195	-5.1096	-34.0487	0.1099	-0.0987	10.4603	-4.5391	-33.4099	21.9787	-5.68	-34.6875
0.48	18.6419	-5.4987	-34.9527	0.1227	-0.1721	11.9358	-4.3334	-34.113	25.3481	-6.6641	-35.7924
0.496	18.1129	-5.4519	-35.2232	0.0908	-0.1476	11.1705	-4.4199	-34.5838	25.0554	-6.484	-35.8625
0.512	19.3818	-5.6442	-35.8988	0.1477	-0.2018	13.8193	-4.5063	-35.0542	24.9443	-6.7821	-36.7433
0.528	20.1823	-5.9689	-35.5704	0.0998	-0.1623	13.3345	-4.8474	-34.8753	27.0301	-7.0903	-36.2655
0.544	20.6598	-6.1327	-35.8943	0.0502	-0.1577	14.4431	-5.1444	-35.5783	26.8764	-7.1211	-36.2103
0.56	22.7064	-6.4328	-36.2319	-0.0125	-0.1176	16.635	-5.7153	-36.3085	28.7779	-7.1503	-36.1554
0.576	23.4853	-7.1726	-37.1934	-0.1673	-0.1086	17.593	-6.5302	-38.1941	29.3776	-7.8149	-36.1926
0.592	24.2578	-7.3441	-36.8764	-0.2064	-0.1173	18.3031	-6.6422	-38.1319	30.2124	-8.0459	-35.6209
0.608	25.6956	-7.2875	-36.7378	-0.1417	-0.1241	19.7865	-6.5503	-37.5875	31.6046	-8.0246	-35.8881
0.624	26.1707	-7.7006	-36.954	-0.1808	-0.0834	20.0478	-7.1887	-38.0769	32.2936	-8.2125	-35.8312
0.64	27.2591	-7.34	-36.5584	-0.2766	-0.0782	21.3281	-6.875	-38.2475	33.1901	-7.8049	-34.8694
0.656	28.3324	-7.6821	-37.1206	-0.3211	-0.0562	22.9785	-7.3807	-38.9045	33.6863	-7.9835	-35.3368
0.672	27.8758	-7.3817	-37.1988	-0.2659	-0.1527	21.7702	-6.4419	-38.8811	33.9815	-8.3216	-35.5164
0.688	29.0771	-7.4371	-37.3948	-0.4832	-0.0478	23.6993	-7.18	-40.2195	34.4549	-7.6943	-34.57
0.704	29.6541	-7.4051	-37.2548	-0.4181	-0.0771	24.131	-6.9787	-39.7162	35.1773	-7.8316	-34.7935
0.72	30.6221	-7.9647	-37.9088	-0.4929	-0.0523	25.3516	-7.6887	-40.7438	35.8927	-8.2407	-35.0737
0.736	31.1735	-7.9086	-37.4599	-0.5403	-0.0817	25.9877	-7.484	-40.5811	36.3594	-8.3332	-34.3386
0.752	31.8434	-7.9614	-37.4806	-0.5622	-0.0623	26.7005	-7.6407	-40.7267	36.9862	-8.2821	-34.2345
0.768	32.3579	-8.1412	-38.0109	-0.6154	-0.0516	27.3598	-7.883	-41.5493	37.3561	-8.3994	-34.4726
0.784	32.589	-8.1334	-37.3087	-0.6737	-0.0467	27.6536	-7.9027	-41.253	37.5245	-8.364	-33.3644
0.8	33.5338	-8.2616	-37.477	-0.6979	-0.0091	28.7157	-8.2177	-41.5184	38.3519	-8.3055	-33.4357
0.816	33.7063	-8.4312	-37.5196	-0.7714	-0.041	29.2113	-8.2467	-41.8939	38.2013	-8.6157	-33.1454
0.832	33.8581	-8.7994	-37.4396	-0.7785	-0.0785	29.1654	-8.4301	-42.0823	38.5507	-9.1687	-32.797
0.848	34.9095	-8.5281	-37.515	-0.8385	-0.0414	30.9276	-8.3629	-41.9475	38.8914	-8.6932	-33.0825
0.864	35.0997	-8.5707	-37.5492	-0.8494	-0.0292	30.8949	-8.448	-42.3324	39.3045	-8.6935	-32.766
0.88	35.4564	-8.5737	-37.7417	-0.8941	0.0168	31.3902	-8.6421	-42.8045	39.5226	-8.5052	-32.679
0.896	36.1191	-8.8039	-38.1621	-0.8831	-0.0184	31.9726	-8.7276	-43.2111	40.2656	-8.8801	-33.1132
0.912	36.0447	-8.8631	-38.0116	-0.9142	0.0413	32.0738	-9.0272	-43.1681	40.0156	-8.6991	-32.8551
0.928	36.3099	-8.8628	-38.8996	-0.8882	0.0792	32.3013	-9.1808	-43.8456	40.3186	-8.5448	-33.9537
0.944	36.8037	-8.9251	-38.6146	-0.8996	0.0581	32.5978	-9.1696	-43.9197	41.0095	-8.6806	-33.3095
0.96	36.9423	-9.1305	-39.2023	-0.8616	-0.0159	32.4488	-9.0591	-44.4396	41.4358	-9.2019	-33.9651
0.976	37.1243	-8.986	-39.0424	-0.8972	-0.046	32.8126	-8.7877	-44.4505	41.4361	-9.1842	-33.6344
0.992	36.5214	-9.1098	-39.7968	-0.9041	0.0625	32.8877	-9.3872	-45.4424	40.9551	-8.8324	-34.1512
1.008	37.2088	-8.864	-40.1499	-0.8958	0.0772	32.9029	-9.197	-45.5456	41.5147	-8.5311	-34.7542
1.024	37.8367	-8.9063	-40.6081	-0.9304	0.1145	33.7591	-9.375	-46.116	41.9142	-8.4376	-35.1002
1.04	37.5988	-9.4118	-41.4753	-0.9034	0.1187	33.3047	-9.9241	-46.9637	41.893	-8.8996	-35.9868
1.056	37.542	-9.3306	-41.8737	-0.934	0.1032	33.8039	-9.7178	-46.955	41.28	-8.9435	-36.7924
1.072	37.8485	-9.1339	-42.1906	-0.9067	0.0935	33.8953	-9.5046	-47.2638	41.8018	-8.7632	-37.1174
1.088	37.8855	-9.1486	-42.6183	-0.9303	0.0881	33.9532	-9.4959	-47.9148	41.8177	-8.8013	-37.3218
1.104	37.7196	-9.2603	-43.4194	-0.929	0.1316	33.7387	-9.7871	-48.793	41.7004	-8.7336	-38.0458
1.12	38.0767	-9.5757	-44.265	-0.9354	0.1064	34.3666	-9.9719	-49.325	41.7868	-9.1794	-39.2051
1.136	38.035	-9.6024	-45.2399	-0.939	0.1709	34.2524	-10.2551	-50.4846	41.8176	-8.9496	-39.9952

Rock4

time	pos(x)	pos(y)	pos(z)	el	az	x1	y1	z1	x2	y2	z2
1.152	38.0604	-10.0676	-45.6309	-0.8947	0.0861	33.9826	-10.4196	-50.7331	42.1383	-9.7157	-40.5287
1.168	37.7469	-9.771	-46.5131	-0.889	0.1185	33.8544	-10.2346	-51.3426	41.6395	-9.3074	-41.6836
1.184	38.1491	-9.7352	-46.9266	-0.7731	0.1273	33.5732	-10.3209	-51.4281	42.725	-9.1495	-42.425
1.2	38.3106	-10.1233	-48.199	-0.7057	0.097	33.2898	-10.612	-52.4977	43.3315	-9.6345	-43.9004
1.216	38.641	-10.0781	-48.9566	-0.7486	0.1275	33.9139	-10.6842	-53.3839	43.3682	-9.4721	-44.5293
1.232	37.8203	-10.3893	-50.59	-0.7305	0.074	33.0752	-10.7409	-54.8528	42.5654	-10.0378	-46.3272
1.248	37.4968	-10.1773	-50.7068	-0.7058	0.0702	32.5107	-10.5279	-54.9668	42.4829	-9.8267	-46.4468
1.264	38.4499	-10.4383	-51.5648	-0.6576	0.1048	33.5241	-10.9561	-55.3896	43.3756	-9.9204	-47.74
1.28	38.3737	-10.4494	-52.2452	-0.621	0.0671	33.2951	-10.7908	-55.887	43.4522	-10.108	-48.6035
1.296	38.0843	-10.7642	-53.3755	-0.5266	0.0733	33.0454	-11.1341	-56.3128	43.1232	-10.3942	-50.4382
1.312	37.9329	-10.6379	-53.9452	-0.5009	0.0906	33.2532	-11.0629	-56.5175	42.6126	-10.213	-51.373
1.328	38.156	-10.7926	-54.3451	-0.37	0.0454	32.92	-11.0303	-56.3782	43.392	-10.555	-52.3121
1.344	38.1699	-10.6028	-55.0211	-0.305	0.0502	32.4207	-10.8916	-56.8331	43.9192	-10.314	-53.209
1.36	38.4493	-11.0737	-55.7191	-0.2767	0.0653	33.2923	-11.4109	-57.1866	43.6063	-10.7365	-54.2515
1.376	38.2386	-10.8484	-56.5655	-0.2041	-0.0087	32.735	-10.8007	-57.7046	43.7423	-10.896	-55.4264
1.392	37.457	-11.2187	-57.4949	-0.1323	0.0655	32.0553	-11.5728	-58.215	42.8587	-10.8646	-56.7747
1.408	37.9859	-11.5985	-58.1343	-0.1375	0.0101	32.2164	-11.657	-58.9329	43.7554	-11.54	-57.3357
1.424	37.8575	-11.7631	-58.7452	-0.0065	-0.0517	32.3878	-11.4801	-58.7809	43.3271	-12.046	-58.7095
1.44	38.3572	-12.1518	-59.8297	0.0174	-0.0434	32.5389	-11.8989	-59.7282	44.1755	-12.4047	-59.9312
1.456	37.9602	-12.1879	-60.803	0.0169	-0.0176	32.5647	-12.0929	-60.7119	43.3557	-12.283	-60.8941
1.472	37.9851	-12.5864	-61.8417	0.0594	-0.0534	31.9751	-12.2649	-61.4836	43.9951	-12.908	-62.1998
1.488	38.004	-12.4308	-62.3095	0.0342	-0.0153	32.5605	-12.3472	-62.1232	43.4476	-12.5143	-62.4958
1.504	39.2402	-12.6351	-63.5851	0.0938	-0.0301	34.2484	-12.4848	-63.115	44.232	-12.7854	-64.0551
1.52	39.5134	-12.5839	-64.2441	0.0788	0.0224	35.732	-12.6685	-63.9454	43.2948	-12.4992	-64.5429
1.536	39.2895	-12.3149	-64.0891	0.1338	-0.026	35.2572	-12.2099	-63.5463	43.3219	-12.4198	-64.632
1.552	39.0623	-12.1201	-65.0213	0.0193	0.081	35.8057	-12.3845	-64.9581	42.3188	-11.8558	-65.0845
1.568	39.3222	-12.5579	-65.6718	0.0503	-0.004	35.6363	-12.5431	-65.4862	43.0081	-12.5726	-65.8575
1.584	39.225	-12.5846	-66.5837	0.0967	-0.0191	35.5977	-12.5154	-66.2318	42.8523	-12.6538	-66.9356
1.6	40.1108	-12.6763	-67.3245	0.1444	-0.014	36.7635	-12.6295	-66.8375	43.4581	-12.7232	-67.8114
1.616	40.2595	-12.7215	-67.9812	0.1937	-0.0215	36.7168	-12.6452	-67.286	43.8023	-12.7978	-68.6764
1.632	40.2654	-12.5325	-68.2867	0.1384	-0.0408	36.2898	-12.37	-67.7325	44.2411	-12.695	-68.8408
1.648	40.384	-12.6967	-68.8396	0.1767	-0.0683	36.188	-12.4097	-68.0886	44.5801	-12.9838	-69.5907
1.664	39.9975	-12.6697	-69.6083	0.1649	-0.0321	35.579	-12.5278	-68.8727	44.4159	-12.8116	-70.344
1.68	39.9646	-13.014	-70.5102	0.1317	-0.0205	34.2045	-12.8957	-69.747	45.7246	-13.1324	-71.2734
1.696	40.3006	-13.1985	-71.2857	0.1617	-0.0209	34.5741	-13.0788	-70.3516	46.027	-13.3182	-72.2198
1.712	40.2973	-13.6756	-72.9881	0.3788	-0.3614	35.6792	-11.9299	-71.0229	44.9153	-15.4212	-74.9533
1.728	40.2444	-14.0546	-73.5345	0.2743	-0.3756	35.6296	-12.2351	-72.1385	44.8591	-15.8742	-74.9305
1.744	40.7978	-13.3585	-74.8348	0.2949	-0.3584	35.7611	-11.4718	-73.2012	45.8345	-15.2451	-76.4683
1.76	40.5979	-13.6794	-75.3584	0.2049	-0.3862	36.3225	-11.941	-74.3992	44.8732	-15.4179	-76.3175
1.776	41.1044	-13.7754	-76.2344	0.2126	-0.3735	36.8682	-12.1151	-75.252	45.3406	-15.4357	-77.2168
1.792	41.5048	-13.9872	-76.8037	0.3085	-0.4355	37.1622	-11.9668	-75.2773	45.8473	-16.0076	-78.3301
1.808	41.5187	-14.1457	-77.5344	0.2706	-0.4605	37.4278	-12.1162	-76.2675	45.6096	-16.1752	-78.8014
1.824	42.0083	-14.1737	-77.8008	0.2273	-0.5008	38.2668	-12.126	-76.8142	45.7497	-16.2214	-78.7874
1.84	42.2057	-14.0782	-78.6465	0.175	-0.5286	38.7958	-12.0868	-77.9483	45.6156	-16.0697	-79.3448
1.856	42.1708	-14.5889	-79.3854	0.1834	-0.6097	38.874	-12.2861	-78.6394	45.4676	-16.8917	-80.1315
1.872	42.5099	-14.1263	-80.1717	0.2219	-0.6248	39.1503	-11.7035	-79.2373	45.8695	-16.5491	-81.1061
1.888	43.0458	-14.35	-81.549	0.3342	-0.6889	39.5557	-11.4762	-79.9792	46.5359	-17.2238	-83.1189
1.904	43.8795	-14.5768	-82.2627	0.355	-0.7399	41.2152	-12.1444	-80.9252	46.5438	-17.0092	-83.6002
1.92	44.2906	-14.2355	-82.9937	0.2963	-0.6859	41.0684	-11.5982	-81.7224	47.5129	-16.8728	-84.265
1.936	44.1843	-15.1649	-83.9525	0.3658	-0.7566	41.1443	-12.2952	-82.351	47.2243	-18.0346	-85.5539
1.952	44.2922	-14.6684	-84.2258	0.3714	-0.8329	41.6957	-11.8127	-82.7227	46.8888	-17.5242	-85.7288
1.968	44.743	-15.4302	-84.903	0.3616	-0.7743	41.6504	-12.4053	-83.2669	47.8356	-18.4551	-86.5392
1.984	45.4675	-15.6498	-85.9797	0.366	-0.749	42.069	-12.49	-84.2013	48.8661	-18.8096	-87.7582
2	45.927	-15.5851	-86.4865	0.3751	-0.7399	42.4176	-12.3811	-84.6157	49.4364	-18.789	-88.3573
2.016	46.2484	-15.6819	-86.8344	0.4042	-0.8446	42.8433	-11.8479	-84.6412	49.6535	-19.5159	-89.0277
2.032	47.7202	-16	-87.7798	0.4389	-1.0534	45.4957	-12.0916	-85.6689	49.9447	-19.9084	-89.8907
2.048	48.1376	-15.7567	-88.398	0.517	-1.1945	46.837	-12.4647	-86.3855	49.4382	-19.0486	-90.4106
2.064	47.7633	-15.7795	-89.2015	0.5892	-1.1332	46.0233	-12.0606	-86.4575	49.5033	-19.4984	-91.9455
2.08	47.9893	-15.507	-89.9691	0.4988	-0.8614	44.9263	-11.939	-87.4077	51.0524	-19.075	-92.5305
2.096	48.4571	-15.5055	-90.3129	0.5758	-0.9568	45.6767	-11.5608	-87.1798	51.2375	-19.4502	-93.446
2.112	48.8893	-15.8247	-90.5895	0.5898	-1.1593	47.0457	-11.6008	-87.5048	50.7328	-20.0486	-93.6742
2.128	49.2305	-15.8632	-91.2003	0.5391	-1.2713	47.9797	-11.8121	-88.6641	50.4812	-19.9144	-93.7366
2.144	49.5308	-15.9994	-91.9054	0.5715	-1.4472	48.923	-11.1057	-88.7345	50.1385	-20.893	-95.0763
2.16	50.2313	-16.2636	-92.3355	0.5734	-1.4435	49.5934	-11.278	-89.0898	50.8692	-21.2492	-95.5812
2.176	51.4528	-16.5421	-93.4316	0.5503	-1.3383	50.249	-11.457	-90.2258	52.6566	-21.6272	-96.6375
2.192	52.3115	-16.3419	-93.6042	0.6229	-1.4059	51.4933	-11.4252	-90.0237	53.1296	-21.2586	-97.1847

Rock4

time	pos(x)	pos(y)	pos(z)	el	az	x1	y1	z1	x2	y2	z2
2.208	52.5242	-16.5707	-93.9264	0.577	-1.4341	51.8227	-11.4723	-90.5768	53.2257	-21.669	-97.276
2.224	51.0407	-17.0332	-94.3367	0.6296	-1.5423	50.8846	-11.5526	-90.3424	51.1967	-22.5138	-98.331
2.24	51.6477	-16.9038	-95.2846	0.6668	-1.5303	51.4131	-11.1068	-90.7186	51.8824	-22.7008	-99.8506
2.256	51.8319	-16.7091	-95.0021	0.6125	-1.5725	51.8412	-11.3946	-91.2682	51.8226	-22.0236	-98.736
2.272	51.5865	-17.3127	-96.4343	0.645	-1.6334	51.9358	-11.7399	-92.2334	51.2371	-22.8854	-100.6352
2.288	51.7387	-17.3269	-96.8214	0.6446	-1.6509	52.1999	-11.5818	-92.4888	51.2775	-23.0721	-101.154
2.304	52.2847	-17.2639	-97.1509	0.6528	-1.6751	52.8941	-11.4404	-92.6737	51.6753	-23.0874	-101.6281
2.32	52.0151	-17.4997	-97.843	0.6851	-1.7368	52.9367	-11.9977	-93.285	51.0935	-23.0017	-102.4011
2.336	52.2535	-17.341	-98.4944	0.6632	-1.7416	53.2297	-11.6806	-94.0073	51.2773	-23.0015	-102.9815
2.352	52.5965	-17.9011	-99.5161	0.6312	-1.7504	53.6837	-11.9116	-95.0666	51.5093	-23.8907	-103.9657
2.368	52.6296	-17.8079	-99.474	0.6277	-1.6824	53.2697	-12.0968	-95.3045	51.9894	-23.519	-103.6436
2.384	52.7984	-18.4985	-100.5555	0.6334	-1.7392	53.7801	-12.7227	-96.2533	51.8167	-24.2744	-104.8576
2.4	52.207	-18.4445	-101.2754	0.6437	-1.7123	53.0063	-12.8328	-97.022	51.4076	-24.0563	-105.5288
2.416	52.8779	-18.8279	-102.2573	0.6317	-1.773	54.0534	-13.0925	-97.9733	51.7024	-24.5633	-106.5413
2.432	52.7088	-18.8815	-102.9277	0.6259	-1.8007	54.1407	-12.7626	-98.3851	51.2769	-25.0003	-107.4703
2.448	53.1017	-18.6171	-103.6334	0.636	-1.7726	54.2335	-13.0846	-99.4641	51.97	-24.1497	-107.8027
2.464	53.0709	-19.4614	-104.5527	0.637	-1.7743	54.2481	-13.7564	-100.2426	51.8936	-25.1664	-108.8628
2.48	52.8586	-19.509	-105.0926	0.5973	-1.7599	53.9421	-13.8476	-101.1719	51.775	-25.1703	-109.0133
2.496	53.4521	-19.7104	-106.0873	0.5861	-1.773	54.5641	-14.2869	-102.4117	52.3402	-25.1339	-109.763
2.512	53.3995	-20.0903	-107.0365	0.6385	-1.763	54.4629	-14.6261	-102.9044	52.3361	-25.5546	-111.1686
2.528	52.7952	-20.9211	-108.1411	0.6047	-1.7621	53.8114	-15.6729	-104.4473	51.779	-26.1693	-111.8349
2.544	53.7315	-20.5708	-108.7697	0.6563	-1.6645	54.2031	-15.5507	-104.8859	53.2599	-25.591	-112.6536
2.56	52.6257	-20.7324	-109.8344	0.6744	-1.5506	53.1677	-15.8859	-105.9595	53.3637	-25.5788	-113.7093
2.576	53.9481	-20.8924	-110.5791	0.6344	-1.6458	54.3254	-15.8721	-106.8745	53.5709	-25.9127	-114.2837
2.592	53.7165	-20.8373	-111.2519	0.6422	-1.4991	53.3894	-16.2844	-107.8378	54.0435	-25.3902	-114.6661
2.608	52.9473	-21.0613	-112.2173	0.6708	-1.3638	52.0058	-16.5773	-108.5814	53.8888	-25.5453	-115.8532
2.624	52.6529	-21.9157	-113.3015	0.6216	-1.1785	50.7444	-17.3032	-109.7257	54.5615	-26.5281	-116.8772
2.64	52.1541	-21.7442	-114.5846	0.6494	-1.0822	49.9323	-17.5647	-110.9907	54.3758	-25.9238	-118.1785
2.656	51.5237	-21.7899	-115.4511	0.6819	-1.0792	49.4787	-17.9702	-111.9336	53.5687	-25.6096	-118.9686
2.672	51.9999	-22.2015	-116.7798	0.7011	-1.0539	49.8949	-18.4985	-113.1843	54.1049	-25.9046	-120.3753
2.688	51.6797	-22.6229	-117.4018	0.6974	-0.8803	49.0607	-19.4529	-113.9568	54.2988	-25.7928	-120.8468
2.704	51.1214	-22.3245	-118.1008	0.5553	-0.7475	47.9548	-19.389	-115.422	54.288	-25.2599	-120.7796
2.72	51.2592	-22.7731	-118.9932	0.4676	-0.668	47.8867	-20.1121	-116.8242	54.6317	-25.4341	-121.1623
2.736	51.0928	-22.6487	-119.7279	0.4659	-0.5576	47.4062	-20.3495	-117.5432	54.7794	-24.948	-121.9126
2.752	50.9162	-22.4687	-120.8327	0.3851	-0.5217	47.1897	-20.3268	-119.0907	54.6426	-24.6106	-122.5747
2.768	50.6304	-22.5714	-121.4068	0.3282	-0.3137	45.8856	-21.0321	-119.7081	55.3752	-24.1108	-123.1054
2.784	50.3212	-22.8382	-122.2861	0.2947	-0.1696	45.6569	-22.0395	-120.8498	54.9856	-23.6368	-123.7224
2.8	50.3346	-22.7285	-123.4628	0.2467	-0.1766	45.1483	-21.803	-122.1363	55.5209	-23.6541	-124.7894
2.816	49.6477	-22.6403	-123.5123	0.0985	-0.0846	44.3734	-22.1932	-122.9889	54.9221	-23.0874	-124.0356
2.832	50.0132	-22.6423	-124.4694	0.1075	-0.063	44.4783	-22.2933	-123.8707	55.548	-22.9913	-125.0681
2.848	50.7544	-21.4554	-124.698	0.1276	-0.4342	46.3997	-19.4361	-124.0824	55.1091	-23.4746	-125.3136
2.864	50.4456	-21.7758	-125.3692	0.2868	-0.4643	46.3253	-19.7124	-124.0099	54.5659	-23.8392	-126.7284
2.88	50.4537	-21.453	-125.7645	0.4749	-0.4938	46.3609	-19.2499	-123.3746	54.5465	-23.6561	-128.1543
2.896	50.2368	-20.9183	-126.6519	0.5361	-0.4976	46.1464	-18.6967	-123.8866	54.3271	-23.1399	-129.4172
2.912	50.0215	-20.4793	-126.5703	0.6455	-0.6813	46.3336	-17.4888	-122.9945	53.7094	-23.4698	-130.146
2.928	49.9414	-21.2002	-127.6172	0.625	-0.7789	46.3048	-17.6109	-123.9305	53.5779	-24.7895	-131.3038
2.944	49.2526	-21.5204	-128.3047	0.7057	-0.8836	46.194	-17.793	-124.1962	52.3113	-25.2477	-132.4132
2.96	49.6186	-21.0802	-128.7119	0.7816	-0.8777	46.8181	-17.7084	-124.3621	52.4191	-24.4521	-133.0618
2.976	49.8305	-20.8982	-129.1186	0.7776	-0.8663	46.9657	-17.528	-124.7636	52.6952	-24.2684	-133.4736
2.992	49.9418	-20.9231	-130.0311	0.7908	-0.9441	47.1818	-17.1114	-125.2739	52.7019	-24.7347	-134.7882
3.008	50.0115	-21.2236	-131.1533	0.7901	-0.8952	47.052	-17.5309	-126.3762	52.9711	-24.9163	-135.9304
3.024	50.1536	-21.3083	-131.8581	0.8021	-0.9102	47.5418	-17.9472	-127.4571	52.7653	-24.6695	-136.2591
3.04	50.2142	-21.1641	-132.7851	0.8218	-1.1757	48.5495	-17.1726	-128.1334	51.8789	-25.1556	-137.4367
3.056	50.4028	-21.5979	-133.4522	0.8299	-1.2175	49.029	-17.8726	-129.1116	51.7766	-25.3232	-137.7928
3.072	49.9586	-21.6012	-133.8236	0.843	-1.2407	48.656	-17.7998	-129.3137	51.2611	-25.4026	-138.3334
3.088	49.5655	-22.0513	-135.2275	0.8515	-1.1998	48.0653	-18.1943	-130.5023	51.0658	-25.9084	-139.9527
3.104	49.5648	-22.681	-136.2186	0.847	-1.2717	48.3908	-18.8741	-131.7109	50.7389	-26.4879	-140.7262
3.12	49.6698	-22.2236	-136.8068	0.8437	-1.215	48.2666	-18.4474	-132.2785	51.073	-25.9998	-141.3351
3.136	49.8461	-22.4487	-137.8276	0.8585	-1.0197	47.7911	-19.105	-133.2829	51.9012	-25.7925	-142.3723
3.152	49.8785	-22.8339	-138.6642	0.8559	-1.0281	47.7999	-19.3872	-134.0274	51.9571	-26.2806	-143.3011
3.168	50.0227	-22.7716	-139.7195	0.8225	-1.1973	48.5229	-18.9447	-135.2925	51.5225	-26.5986	-144.1464
3.184	49.7194	-23.2464	-140.904	0.8692	-1.2338	48.4432	-19.6035	-136.336	50.9957	-26.8893	-145.4719
3.2	49.7157	-23.732	-141.7692	0.8273	-1.304	48.7222	-20.0963	-137.6707	50.7092	-27.3676	-145.8677
3.216	50.477	-24.3475	-143.406	0.8715	-1.1377	48.7989	-20.718	-138.6516	52.1552	-27.9771	-148.1604
3.232	50.1417	-24.309	-143.7071	0.8187	-1.3695	49.2957	-20.1642	-139.1854	50.9877	-28.4537	-148.2289
3.248	51.1206	-24.0174	-145.4242	0.8271	-1.2545	49.9276	-20.3726	-141.2551	52.3135	-27.6622	-149.5933

Rock4

time	pos(x)	pos(y)	pos(z)	el	az	x1	y1	z1	x2	y2	z2
3.264	51.4376	-24.8803	-146.3126	0.7945	-1.3542	50.5315	-20.7624	-142.0192	52.3437	-28.9982	-150.6061
3.28	51.4356	-24.8657	-147.3133	0.7541	-1.3559	50.5541	-20.8262	-143.43	52.3171	-28.9052	-151.1965
3.296	51.7344	-25.2302	-148.1149	0.7202	-1.4337	51.0733	-20.4382	-143.8706	52.3954	-30.0222	-152.3593
3.312	52.1085	-25.9371	-149.1044	0.7485	-1.4397	51.5719	-21.867	-145.2916	52.6451	-30.0071	-152.9171
3.328	52.2319	-26.4257	-150.3065	0.7194	-1.4401	51.6755	-22.1937	-146.567	52.7882	-30.6577	-154.046
3.344	51.4526	-27.2267	-151.7047	0.7556	-1.3331	50.5373	-23.4486	-148.0425	52.3678	-31.0048	-155.3669
3.36	52.053	-27.8918	-152.4679	0.6892	-1.2966	51.0203	-24.2197	-149.3247	53.0857	-31.5639	-155.6111
3.376	51.9786	-28.4993	-153.2117	0.6865	-1.1273	50.2525	-24.8657	-149.9155	53.7047	-32.1328	-156.5079
3.392	51.7541	-28.5626	-153.9877	0.6653	-1.073	49.8947	-25.1406	-150.9321	53.6136	-31.9845	-157.0433
3.408	53.3584	-29.3169	-155.1446	0.6653	-1.149	51.9252	-26.1229	-152.3976	54.7915	-32.5109	-157.8916
3.424	53.1715	-30.3246	-156.0115	0.7065	-0.9688	51.5	-27.8915	-153.4921	54.8431	-32.7576	-158.5308
3.44	53.7147	-29.9939	-156.3228	0.5177	-0.9554	52.0025	-27.5718	-154.6337	55.4269	-32.4159	-158.012
3.456	53.8394	-30.5802	-157.4544	0.3301	-0.5183	51.3325	-29.1505	-156.4656	56.3462	-32.0098	-158.4432
3.472	53.0404	-31.1883	-158.2648	0.1599	-0.4463	49.7006	-29.5901	-157.6675	56.3802	-32.7864	-158.8622
3.488	53.5555	-31.6604	-158.6768	0.0979	-0.1636	49.1404	-30.9314	-158.2374	57.9707	-32.3893	-159.1162
3.504	53.2604	-32.87	-160.2417	-0.2108	-0.093	48.9728	-32.4703	-161.1631	57.5481	-33.2697	-159.3204
3.52	53.4005	-32.467	-160.7411	-0.2603	-0.3385	49.5878	-31.1248	-161.8176	57.2132	-33.8091	-159.6647
3.536	54.2419	-33.3685	-161.0957	-0.2053	-0.0424	49.0792	-33.1497	-162.1716	59.4047	-33.5874	-160.0198
3.552	53.9516	-33.5295	-161.8111	-0.1846	-0.1002	48.7612	-33.0075	-162.7851	59.1421	-34.0514	-160.8371
3.568	54.4414	-33.7532	-162.0709	-0.2821	-0.1786	49.3537	-32.8348	-163.5694	59.5291	-34.6716	-160.5724
3.584	55.6164	-33.9696	-162.5428	-0.3145	-0.07	51.0952	-33.6525	-164.0173	60.1376	-34.2866	-161.0682
3.6	55.7495	-34.3785	-162.7216	-0.3322	-0.0926	51.0959	-33.9462	-164.3341	60.4031	-34.8107	-161.1092
3.616	56.5343	-34.5339	-162.9786	-0.3055	-0.1291	52.0753	-33.9551	-164.3968	60.9932	-35.1127	-161.5605
3.632	57.0574	-34.4147	-162.7051	-0.2816	-0.1132	52.3292	-33.8771	-164.0816	61.7856	-34.9523	-161.3286
3.648	57.2601	-35.058	-164.2259	-0.3144	-0.0242	52.3347	-34.9386	-165.8283	62.1854	-35.1773	-162.6236
3.664	57.4026	-35.5892	-164.7066	-0.301	0.0038	52.3494	-35.6083	-166.2751	62.4559	-35.5702	-163.1381
3.68	57.3459	-35.987	-165.3414	-0.4061	0.0227	52.6354	-36.0942	-167.3675	62.0563	-35.7799	-163.3154
3.696	58.1981	-35.3746	-165.2972	-0.5088	-0.0094	53.5965	-35.3312	-167.8639	62.7998	-35.4179	-162.7305
3.712	59.4624	-35.3747	-165.6729	-0.5211	0.0216	54.7843	-35.4757	-168.3589	64.1405	-35.2736	-162.9869
3.728	60.4914	-34.9491	-165.4823	-0.579	0.0219	56.2175	-35.0426	-168.2771	64.7654	-34.8557	-162.6874
3.744	61.201	-34.9534	-165.6214	-0.64	0.0391	56.9328	-35.1202	-168.8017	65.4692	-34.7866	-162.4411
3.76	61.7024	-34.758	-166.22	-0.7262	-0.061	57.7192	-34.5146	-169.7638	65.6855	-35.0013	-162.6762
3.776	61.9053	-34.6336	-166.2846	-0.7157	-0.1498	58.1104	-34.0607	-169.6216	65.7002	-35.2065	-162.9476
3.792	62.302	-34.4831	-166.3617	-0.7447	-0.0373	58.8311	-34.3535	-169.5634	65.7728	-34.6128	-163.16
3.808	62.3287	-34.6318	-166.5668	-0.8709	-0.2369	58.9266	-33.8104	-170.7232	65.7309	-35.4531	-162.4104
3.824	62.9992	-33.7672	-167.152	-0.7848	-0.2497	59.1625	-32.7887	-171.1067	66.8359	-34.7457	-163.1973
3.84	62.9074	-34.5037	-166.9032	-0.879	-0.2164	59.5316	-33.7617	-171.0759	66.2832	-35.2457	-162.7306
3.856	63.7446	-34.5393	-167.6667	-1.0395	-0.5907	61.7374	-33.1933	-171.7795	65.7517	-35.8853	-163.5539
3.872	64.1808	-34.319	-167.5744	-1.0173	-0.4722	61.7482	-33.0765	-171.9947	66.6134	-35.5616	-163.1541
3.888	64.5604	-34.4307	-167.8309	-1.0837	-0.7608	62.8837	-32.8344	-172.2015	66.2371	-36.0269	-163.4603
3.904	64.829	-33.9934	-168.3164	-1.0479	-0.9372	63.3992	-32.0473	-172.5061	66.2588	-35.9395	-164.1268
3.92	64.4117	-34.4006	-168.7914	-1.056	-0.9767	62.9768	-32.2766	-173.3229	65.8467	-36.5247	-164.2599
3.936	64.9822	-34.1366	-169.1674	-1.0587	-0.9771	63.6085	-32.1013	-173.536	66.3559	-36.1718	-164.7987
3.952	64.7847	-34.2806	-170.0378	-1.0497	-1.2362	63.9215	-31.798	-174.6166	65.6478	-36.7631	-165.459
3.968	65.184	-34.403	-170.0994	-1.0476	-1.2603	64.4408	-32.087	-174.3165	65.9273	-36.719	-165.8823
3.984	64.9568	-34.6431	-170.682	-1.0473	-1.3168	64.3289	-32.2241	-175.0113	65.5847	-37.062	-166.3527
4	65.8905	-34.1983	-171.6728	-1.1022	-1.2361	65.0794	-31.8666	-176.5496	66.7015	-36.53	-166.7961
4.016	65.955	-34.2926	-172.1346	-1.056	-1.2506	65.1311	-31.8077	-176.7623	66.7789	-36.7776	-167.5068
4.032	65.994	-34.1244	-172.8375	-1.0222	-1.3054	65.2919	-31.5412	-177.2174	66.696	-36.7075	-168.4575
4.048	65.8133	-34.3308	-173.2922	-1.0338	-1.3382	65.2272	-31.8566	-177.5628	66.3995	-36.805	-169.0216
4.064	66.2682	-34.1548	-174.5495	-1.0737	-1.1365	65.2283	-31.9129	-179.1043	67.3082	-36.3967	-169.9948
4.08	65.7047	-34.4934	-175.0579	-1.017	-1.3598	65.1461	-31.8856	-179.3709	66.2633	-37.1012	-170.745
4.096	65.6817	-34.54	-175.9679	-0.9554	-1.2132	64.7257	-31.9814	-179.8315	66.6377	-37.0986	-172.1043
4.112	65.8004	-34.732	-176.5713	-0.916	-1.487	65.5403	-31.6362	-180.6178	66.0604	-37.8279	-172.5248
4.128	66.0914	-34.7077	-177.0021	-0.8794	-1.2897	65.2289	-31.7204	-180.7586	66.9539	-37.695	-173.2457
4.144	65.7219	-34.4181	-178.1225	-0.8218	-1.4316	65.2733	-31.2157	-181.6009	66.1704	-37.6204	-174.6441
4.16	66.2214	-34.6478	-178.8034	-0.7905	-1.3011	65.3805	-31.6053	-181.9926	67.0623	-37.6903	-175.6143
4.176	65.9797	-34.6201	-179.651	-0.6772	-1.3963	65.385	-31.2467	-182.4049	66.5744	-37.9935	-176.8971
4.192	65.7488	-34.9328	-180.1926	-0.6413	-1.2907	64.851	-31.8115	-182.6172	66.6467	-38.054	-177.768
4.208	65.6279	-34.8994	-181.0047	-0.556	-1.2157	64.4618	-31.7551	-183.0886	66.794	-38.0437	-178.9208
4.224	65.2904	-34.873	-181.8108	-0.437	-1.2527	64.1994	-31.5602	-183.44	66.3814	-38.1857	-180.1817
4.24	64.7681	-34.9525	-182.3935	-0.4161	-1.0445	63.0565	-32.0065	-183.8989	66.4797	-37.8984	-180.888
4.256	64.9039	-35.0918	-183.2245	-0.3292	-0.9688	63.0556	-32.4018	-184.3397	66.7521	-37.7817	-182.1094
4.272	65.1763	-35.0523	-183.6562	-0.2247	-1.0737	63.4855	-31.9358	-184.4665	66.8671	-38.1688	-182.8459
4.288	65.9969	-33.8176	-184.3193	-0.1675	-1.1964	64.6636	-30.4245	-184.9357	67.3302	-37.2107	-183.7029
4.304	65.5908	-34.2576	-185.592	-0.1325	-1.4459	65.0743	-30.1439	-186.1447	66.1073	-38.3712	-185.0394

Rock4

time	pos(x)	pos(y)	pos(z)	el	az	x1	y1	z1	x2	y2	z2
4.32	66.3361	-33.871	-186.3292	-0.1119	-1.4431	65.808	-29.7564	-186.7955	66.8642	-37.9856	-185.8629
4.336	66.1262	-34.1463	-186.6999	0.0735	-1.3926	65.4089	-30.1641	-186.4018	66.8436	-38.1285	-186.9979
4.352	66.6106	-33.9677	-187.4169	0.2935	-1.3544	65.7485	-30.0453	-186.2031	67.4727	-37.89	-188.6307
4.368	65.8416	-34.9241	-188.4786	0.3594	-1.5058	65.5552	-30.522	-186.8214	66.128	-39.3262	-190.1358
4.384	65.3387	-35.0704	-188.7611	0.3811	-1.0317	63.4081	-31.8432	-187.2543	67.2693	-38.2976	-190.2678
4.4	65.0092	-35.5246	-189.0693	0.3996	-1.1153	63.2774	-31.9893	-187.4069	66.7411	-39.0599	-190.7316
4.416	66.4204	-35.159	-189.8809	0.4386	-1.074	64.6499	-31.893	-188.1385	68.1909	-38.425	-191.6232
4.432	66.285	-34.927	-190.5893	0.4574	-1.1554	64.6331	-31.1818	-188.5744	67.9369	-38.6723	-192.6042
4.448	65.5476	-35.105	-191.0515	0.5471	-1.1704	63.9012	-31.2152	-188.4788	67.1941	-38.9949	-193.6242
4.464	65.5444	-35.2443	-192.0809	0.4696	-1.2587	64.2557	-31.2502	-189.9513	66.8331	-39.2385	-194.2105
4.48	66.4362	-34.9549	-192.5328	0.567	-1.1335	64.749	-31.3459	-189.9959	68.1235	-38.5639	-195.0697
4.496	66.6257	-34.9636	-193.0596	0.6141	-1.0868	64.8192	-31.5276	-190.3225	68.4323	-38.3996	-195.7966
4.512	66.4842	-35.8941	-194.5616	0.6353	-1.3664	65.6764	-31.9961	-191.6267	67.2921	-39.792	-197.4965
4.528	66.1788	-35.8954	-195.0871	0.5937	-1.3423	65.2874	-32.062	-192.431	67.0701	-39.7288	-197.7432
4.544	65.9737	-36.5389	-195.4301	0.5983	-1.2859	64.9445	-33.0246	-192.9342	67.003	-40.0531	-197.926
4.56	65.6699	-36.8622	-196.1282	0.5394	-1.5446	65.5622	-32.7561	-193.6695	65.7777	-40.9684	-198.5869
4.576	66.4476	-36.5455	-196.8564	0.5548	-1.4302	65.9418	-32.9714	-194.6194	66.9534	-40.1196	-199.0933
4.592	66.356	-36.467	-197.6286	0.6136	-1.213	65.1746	-33.3073	-195.253	67.5374	-39.6266	-200.0042
4.608	66.8372	-36.8598	-198.342	0.7215	-1.2176	65.8913	-34.2937	-195.9361	67.7831	-39.426	-200.748
4.624	64.5374	-38.4087	-199.1414	0.4722	-1.5396	64.4075	-34.2459	-197.014	64.6674	-42.5714	-201.2687
4.64	64.6392	-38.8683	-200.6557	0.0478	-1.9553	66.7583	-33.6312	-200.3857	62.5201	-44.1054	-200.9257
4.656	65.2992	-38.7118	-201.0027	0.0517	-1.8019	66.2771	-34.5565	-200.7819	64.3213	-42.8672	-201.2235
4.672	64.9141	-39.0191	-201.5832	-0.0623	-1.9859	66.6554	-35.0677	-201.8528	63.1727	-42.9704	-201.3137
4.688	64.4858	-39.5064	-202.0387	-0.0495	-2.0664	67.1269	-34.6214	-202.3136	61.8448	-44.3913	-201.7639
4.704	64.3668	-39.6066	-202.4739	-0.1303	-2.1477	68.0269	-33.9819	-203.3535	60.7066	-45.2313	-201.5942
4.72	65.8378	-38.9498	-203.2465	-0.1525	-2.0549	68.5244	-33.8411	-204.1334	63.1512	-44.0584	-202.3596
4.736	65.2228	-39.5433	-203.806	-0.126	-2.1369	68.6389	-34.1682	-204.6128	61.8067	-49.1185	-202.9992
4.752	65.2278	-39.8785	-204.567	-0.2881	-2.0856	67.9642	-35.0417	-206.2141	62.4915	-44.7152	-202.9199
4.768	64.8977	-40.5576	-205.285	-0.2412	-2.1326	67.9976	-35.6325	-206.7167	61.7977	-45.4827	-203.8534
4.784	64.8814	-40.8921	-205.5014	-0.2897	-2.1648	67.8782	-36.4551	-207.0975	61.8846	-45.329	-203.9053
4.8	65.1741	-40.6644	-206.25	-0.4195	-2.1851	68.5956	-35.8136	-208.8972	61.7526	-45.5151	-203.6027
4.816	65.8317	-40.4323	-206.9595	-0.4352	-2.2027	69.56	-35.3396	-209.8936	62.1034	-45.525	-204.0254
4.832	65.7949	-40.3117	-206.9112	-0.4495	-2.2229	69.6427	-35.2723	-209.9699	61.947	-45.3511	-203.8526
4.848	65.3585	-40.7114	-208.0615	-0.4865	-2.2212	69.1366	-35.7458	-211.3619	61.5803	-45.677	-204.7611
4.864	63.5889	-42.7456	-207.9013	-0.6499	-2.1284	65.7145	-39.337	-210.9547	61.4634	-46.1542	-204.848
4.88	64.846	-41.7656	-208.3429	-0.5839	-2.2085	67.8786	-37.6724	-211.7091	61.8133	-45.8587	-204.9767
4.896	68.0599	-39.2087	-210.8628	-0.4518	-2.3389	74.9795	-32.0454	-215.6958	61.1404	-46.3721	-206.0298
4.912	66.5304	-40.9539	-210.8833	-0.4731	-2.3605	72.4923	-35.0433	-215.1809	60.5684	-46.8645	-206.5856
4.928	66.8109	-40.626	-211.1154	-0.4659	-2.3838	72.6731	-35.0783	-215.1736	60.9487	-46.1737	-207.0572
4.944	68.6107	-39.4911	-211.9497	-0.4164	-2.4123	76.0463	-32.8459	-216.3599	61.175	-46.1363	-207.5395
4.96	68.6117	-39.4677	-212.196	-0.4392	-2.421	75.4993	-33.4202	-216.502	61.7241	-45.5152	-207.8899
4.976	66.7829	-41.1101	-212.4338	-0.4497	-2.4393	73.9423	-35.0523	-216.9609	59.6236	-47.168	-207.9067
4.992	67.439	-40.8551	-212.8436	-0.4198	-2.4454	74.9475	-34.5792	-217.211	59.9305	-47.131	-208.4762
5.008	67.701	-40.6227	-214.159	-0.4394	-2.4632	74.7733	-34.6222	-218.4293	60.6288	-46.3232	-209.8888
5.024	66.9339	-41.5366	-213.8977	-0.4346	-2.4703	74.485	-35.5381	-218.374	59.3827	-47.5351	-209.4215
5.04	68.6823	-40.0298	-214.8775	-0.3904	-2.4833	75.8754	-34.4666	-218.62	61.4891	-45.5931	-211.1349
5.056	68.7377	-40.1948	-215.9654	-0.3934	-2.4909	77.1926	-33.7575	-220.376	60.2829	-46.632	-211.5548
5.072	69.9818	-39.0606	-216.373	-0.4121	-2.5027	77.84	-33.2234	-220.6526	62.1237	-44.8979	-212.0934
5.088	69.3755	-39.4788	-218.6835	-0.3254	-2.4976	78.0553	-32.9621	-222.3453	60.6957	-45.9955	-215.0217
5.104	67.6788	-41.21	-218.2507	-0.2588	-2.5018	76.2635	-34.8204	-221.0838	59.094	-47.5996	-215.4175
5.12	69.7885	-39.4777	-219.2738	-0.3187	-2.5127	77.8634	-33.6044	-222.5682	61.7136	-45.351	-215.9794
5.136	70.0055	-39.3064	-220.2549	-0.2256	-2.509	78.5123	-33.0695	-222.6762	61.4987	-45.5432	-217.8336
5.152	70.7221	-38.6513	-220.87	-0.2155	-2.5112	78.6848	-32.8407	-223.0281	62.7594	-44.4619	-218.7118
5.168	71.132	-38.2915	-222.1483	-0.2281	-2.4986	78.954	-32.4314	-224.4169	63.3101	-44.1517	-219.8797
5.184	72.0103	-37.6402	-223.1168	-0.2386	-2.4928	79.9053	-31.6535	-225.5268	64.1153	-43.6269	-220.7068
5.2	70.9679	-38.1887	-224.1279	-0.1284	-2.5027	78.9742	-32.241	-225.4153	62.9617	-44.1365	-222.8405
5.216	72.1526	-38.1828	-224.4951	-0.0884	-2.5433	80.7669	-32.3106	-225.4187	63.5384	-44.0551	-223.5715
5.232	72.8786	-38.2777	-224.6122	-0.1171	-2.538	81.9634	-32.0151	-225.9105	63.7938	-44.5403	-223.3139
5.248	73.1353	-37.3634	-225.7757	-0.1059	-2.5416	81.4922	-31.6464	-226.8521	64.7784	-43.0804	-224.6993
5.264	73.4457	-37.5096	-226.269	-0.1695	-2.5293	82.4004	-31.2198	-228.1417	64.491	-43.7994	-224.3964
5.28	74.1135	-36.7037	-227.7891	-0.1568	-2.5499	83.7929	-30.1987	-229.6332	64.434	-43.2087	-225.9451
5.296	73.4511	-37.5575	-228.3412	-0.1113	-2.5573	82.8702	-31.329	-229.6036	64.032	-43.7861	-227.0788
5.312	75.2139	-36.8719	-229.3194	-0.1092	-2.602	85.2896	-30.8384	-230.6072	65.1382	-42.9055	-228.0317
5.328	74.656	-37.3735	-229.3778	-0.0176	-2.5676	84.8221	-30.8005	-229.5913	64.4898	-43.9466	-229.1644
5.344	74.4421	-36.7943	-229.5513	0.004	-2.5494	83.5056	-30.6975	-229.5074	65.3786	-42.891	-229.5953
5.36	74.4523	-36.7354	-230.4793	0.0295	-2.5468	83.4317	-30.6604	-230.1589	65.4729	-42.8104	-230.7997

Rock4

time	pos(x)	pos(y)	pos(z)	el	az	x1	y1	z1	x2	y2	z2
5.376	75.2964	-36.1284	-231.6228	0.0432	-2.5427	85.8524	-28.9238	-231.0706	64.7404	-43.333	-232.1749
5.392	74.3266	-36.503	-232.0848	0.0818	-2.5744	81.5016	-31.932	-231.3874	67.1515	-41.0739	-232.7821
5.408	74.0784	-36.44	-232.9412	0.0972	-2.5793	80.9316	-32.1212	-232.1517	67.2252	-40.7587	-233.7308
5.424	72.4839	-37.3628	-233.256	0.1658	-2.5605	78.0992	-33.6752	-232.1321	66.8686	-41.0504	-234.3799
5.44	72.0851	-37.631	-234.4967	0.0094	-2.5302	79.5167	-32.4218	-234.411	64.6535	-42.8402	-234.5825
5.456	71.1233	-37.9937	-234.6676	0.0574	-2.5555	77.7435	-33.5984	-234.2107	64.503	-42.389	-235.1245
5.472	71.7911	-37.4648	-235.4657	0.019	-2.5223	78.6534	-32.5731	-235.3056	64.9288	-42.3566	-235.6258
5.488	71.5079	-37.5175	-236.0887	-0.0277	-2.5503	78.9475	-32.5222	-236.3371	64.0683	-42.5128	-235.8404
5.504	70.8233	-37.728	-236.4093	-0.0061	-2.5394	78.1944	-32.6611	-236.4642	63.4523	-42.7948	-236.3545
5.52	71.5907	-37.2546	-237.1648	-0.0664	-2.5348	80.4516	-31.1031	-237.8823	62.7298	-43.406	-236.4472
5.536	71.7344	-37.4942	-238.454	-0.0701	-2.5303	79.6572	-31.9413	-239.1329	63.8115	-43.0471	-237.7751
5.552	71.2728	-37.4133	-239.1807	-0.0851	-2.5822	79.9614	-31.9734	-240.055	62.5842	-42.8532	-238.3064
5.568	71.0424	-37.7664	-239.4435	-0.1236	-2.5756	80.3832	-31.8319	-240.8187	61.7016	-43.7008	-238.0682
5.584	70.8879	-37.8327	-240.1514	-0.136	-2.5702	78.8875	-32.0463	-241.6159	61.8883	-43.6191	-238.6869
5.6	71.2044	-37.5642	-240.7862	-0.119	-2.6015	80.6667	-31.8914	-242.1053	61.7422	-43.237	-239.4672
5.616	70.981	-37.7458	-241.6002	-0.1538	-2.6136	80.2114	-32.3621	-243.257	61.7507	-43.1294	-239.9433
5.632	71.0227	-37.5837	-242.1787	-0.1956	-2.5983	80.4766	-31.8739	-244.3671	61.5688	-43.2935	-239.9904
5.648	70.0786	-38.1325	-242.4795	-0.2226	-2.6026	78.9517	-32.8254	-244.8201	61.2055	-43.4396	-240.139
5.664	69.5522	-38.2398	-243.1878	-0.2895	-2.598	78.8528	-32.6189	-246.4248	60.2516	-43.8607	-239.9508
5.68	68.6979	-38.5996	-243.9953	-0.3324	-2.6059	77.74	-33.2325	-247.6249	59.6558	-43.9667	-240.3657
5.696	67.8238	-38.6729	-244.5921	-0.3702	-2.5641	75.8558	-33.439	-248.3129	59.7917	-43.9067	-240.8714
5.712	68.3922	-38.4851	-245.4705	-0.3721	-2.5864	76.6739	-33.3484	-249.2742	60.1106	-43.6218	-241.6669
5.728	68.5659	-38.8394	-245.8733	-0.4019	-2.5963	77.6551	-33.3258	-250.3912	59.4767	-44.3531	-241.3555
5.744	68.8075	-38.5118	-246.643	-0.4368	-2.6334	77.7456	-33.5337	-251.42	59.8694	-43.4898	-241.8659
5.76	68.3646	-38.9408	-247.1764	-0.4297	-2.6064	77.0979	-33.763	-251.8286	59.6313	-44.1186	-242.5243
5.776	68.1905	-39.1451	-247.6818	-0.4809	-2.6243	76.9447	-34.1636	-252.9374	59.4364	-44.1265	-242.4262
5.792	67.7132	-39.3522	-248.5073	-0.4995	-2.6263	76.2671	-34.5076	-253.871	59.1593	-44.1968	-243.1436
5.808	67.2839	-39.0509	-249.1595	-0.531	-2.5973	75.5283	-34.0606	-254.8185	59.0395	-44.0411	-243.5005
5.824	68.0461	-38.652	-250.0734	-0.5453	-2.5807	76.5041	-33.3393	-256.1325	59.5881	-43.9647	-244.0142
5.84	68.3909	-38.9956	-250.6649	-0.5597	-2.6627	76.5483	-34.7604	-256.4233	60.2336	-43.2309	-244.9066
5.856	67.7411	-39.9855	-250.6343	-0.5533	-2.7177	76.1388	-36.1964	-256.3252	59.3435	-43.7747	-244.9434
5.872	67.4368	-39.7459	-251.5847	-0.5737	-2.6667	76.1232	-35.2797	-257.8968	58.7503	-44.212	-245.2727
5.888	67.9664	-39.1274	-251.9617	-0.5984	-2.6935	76.8415	-34.8612	-258.6761	59.0913	-43.3935	-245.2474
5.904	68.0051	-39.3023	-252.703	-0.6368	-2.671	75.4259	-35.5272	-258.8606	60.5844	-43.0774	-246.5454
5.92	67.9674	-39.1277	-253.1496	-0.6425	-2.7202	75.4743	-35.7625	-259.3071	60.4605	-42.493	-246.992
5.936	68.0531	-39.1375	-254.1813	-0.6681	-2.7399	75.0423	-36.1687	-260.1739	61.064	-42.1063	-248.1887
5.952	68.372	-38.5932	-254.6642	-0.7079	-2.7862	74.3404	-36.3778	-260.1124	62.4037	-40.8086	-249.216

Rockan5

time	pos(x)	pos(y)	pos(z)	el	az	x1	y1	z1	x2	y2	z2
0	0	0	0	0.2979	-0.4552	-4.7117	2.3062	1.6107	4.7117	-2.3062	-1.6107
0.016	-0.2288	-1.1013	-2.8193	0.3495	-0.4435	-4.0502	0.7139	-1.2772	3.5927	-2.9166	-4.3614
0.032	0.6617	-1.7518	-5.7471	0.4498	-0.4057	-3.978	0.2409	-3.3091	5.3015	-3.7445	-8.185
0.048	-0.2549	-2.5053	-7.99	0.454	-0.4247	-4.4508	-0.6079	-5.7427	3.9411	-4.4027	-10.2374
0.064	0.7792	-3.2865	-10.7434	0.4993	-0.3967	-3.1698	-1.6321	-8.4085	4.7282	-4.9409	-13.0784
0.08	2.4266	-3.7279	-12.7933	0.5171	-0.4352	-2.254	-1.5517	-9.8576	7.1071	-5.9042	-15.7289
0.096	3.6318	-3.6041	-13.6227	0.4008	-0.3278	-1.3728	-1.9022	-11.3832	8.6363	-5.3061	-15.8623
0.112	9.2648	-3.9303	-14.8782	0.2212	-0.2978	4.2482	-2.3908	-13.6983	14.2814	-5.4698	-16.0582
0.128	9.4328	-4.5357	-15.7393	0.1909	-0.2949	4.9689	-3.1796	-14.8376	13.8968	-5.8918	-16.641
0.144	8.2911	-4.4877	-16.1103	-0.024	-0.2771	4.1924	-3.3221	-16.2128	12.3899	-5.6534	-16.0079
0.16	9.0208	-4.5817	-15.8745	-0.004	-0.3034	4.5514	-3.1826	-15.8931	13.4902	-5.9809	-15.8559
0.176	9.497	-4.9108	-16.9437	-0.0255	-0.4006	5.932	-3.4009	-17.0422	13.062	-6.4208	-16.8451
0.192	10.4464	-4.977	-17.4163	-0.0436	-0.417	6.7805	-3.3531	-17.5912	14.1122	-6.6009	-17.2413
0.208	10.6387	-5.2294	-17.5107	-0.0691	-0.5655	7.7532	-3.3982	-17.7473	13.5241	-7.0606	-17.2741
0.224	12.2557	-5.8984	-17.9963	-0.1841	-0.3789	8.4586	-4.3868	-18.7571	16.0528	-7.4101	-17.2355
0.24	12.7544	-5.6806	-17.7656	-0.2173	-0.4139	8.8202	-3.9527	-18.7141	16.6886	-6.4086	-16.817
0.256	12.8468	-6.0217	-18.2196	-0.3137	-0.3706	8.9244	-4.4978	-19.585	16.7692	-7.5456	-16.8543
0.272	13.6792	-6.4467	-18.5974	-0.3511	-0.3889	10.0433	-4.9569	-20.0365	17.3151	-7.9365	-17.1584
0.288	13.992	-6.9891	-19.2962	-0.3877	-0.3952	10.1506	-5.3868	-20.9958	17.8333	-8.5913	-17.5965
0.304	14.9241	-6.6101	-18.767	-0.3277	-0.4621	11.2346	-4.7725	-20.1682	18.6137	-8.4478	-17.3658
0.32	15.0344	-6.9011	-18.7821	-0.3929	-0.3449	11.104	-5.489	-20.5131	18.9648	-8.3133	-17.0511
0.336	15.5609	-7.1401	-18.9092	-0.4393	-0.412	12.0317	-5.5976	-20.7189	19.09	-8.6826	-17.0994
0.352	15.965	-7.3889	-19.2665	-0.3899	-0.3826	11.941	-5.7697	-21.0492	19.989	-9.0081	-17.4839
0.368	16.0766	-7.7543	-20.126	-0.3992	-0.3241	11.7887	-6.3139	-22.0344	20.3644	-9.1947	-18.2176
0.384	16.4295	-7.3942	-19.7648	-0.4385	-0.3709	12.3918	-5.8239	-21.7966	20.4671	-8.9644	-17.7329

Rock5

time	pos(x)	pos(y)	pos(z)	el	az	x1	y1	z1	x2	y2	z2
0.4	17.0149	-7.8799	-20.0879	-0.5263	-0.341	13.3678	-6.5856	-22.3363	20.6621	-9.1742	-17.8396
0.416	16.7396	-7.9707	-20.0644	-0.5064	-0.3537	12.8987	-6.5523	-22.3354	20.5806	-9.3891	-17.7934
0.432	17.0794	-8.03	-20.131	-0.6507	-0.3551	13.8251	-6.8232	-22.7736	20.3337	-9.2367	-17.4884
0.448	17.3122	-8.14	-20.3854	-0.6866	-0.3906	14.2689	-6.8869	-23.0833	20.3556	-9.3932	-17.6875
0.464	17.7876	-8.0359	-20.3375	-0.7371	-0.3614	14.839	-6.9211	-23.1993	20.7363	-9.1507	-17.4756
0.48	17.8796	-8.2064	-20.5672	-0.7523	-0.2756	14.4741	-7.2432	-23.879	21.285	-9.1695	-17.2553
0.496	17.6467	-8.1797	-20.5349	-0.722	-0.2733	14.0585	-7.1741	-23.8161	21.2348	-9.1853	-17.2537
0.512	18.1348	-8.4058	-20.855	-0.9273	-0.3618	15.6158	-7.4524	-24.4461	20.6538	-9.3591	-17.2639
0.528	18.0101	-8.4182	-20.7664	-0.8902	-0.3863	15.6399	-7.4541	-23.9269	20.3804	-9.3823	-17.606
0.544	18.9319	-8.3608	-21.1013	-0.9142	-0.3663	16.3827	-7.3829	-24.6443	21.4812	-9.3388	-17.5582
0.56	18.4817	-8.3457	-21.1914	-0.9482	-0.3471	16.0531	-7.4672	-24.7889	20.9103	-9.2242	-17.5938
0.576	18.7178	-8.5544	-21.815	-0.9518	-0.2306	15.9468	-7.9037	-25.8101	21.4888	-9.205	-17.8198
0.592	18.8207	-9.2442	-22.6957	-0.9705	-0.2315	16.054	-8.592	-26.8478	21.5874	-9.8964	-18.5435
0.608	18.991	-9.1733	-22.687	-1.0008	-0.2805	16.3	-8.3982	-27.0562	21.682	-9.9484	-18.3178
0.624	19.052	-9.2078	-23.0248	-1.0296	-0.2199	16.4615	-8.6287	-27.4407	21.6424	-9.7869	-18.609
0.64	19.0266	-9.5559	-23.5493	-0.9859	-0.3161	16.3629	-8.6847	-27.7814	21.6902	-10.427	-19.3172
0.656	19.0869	-9.328	-23.3078	-0.9483	-0.2994	16.2271	-8.4452	-27.4782	21.9467	-10.2108	-19.1374
0.672	19.2406	-9.623	-23.48	-0.9887	-0.249	16.3703	-8.8931	-27.9794	22.1109	-10.3528	-19.9805
0.688	19.7272	-9.874	-24.2609	-1.0468	-0.2524	16.9611	-9.1606	-29.204	22.4933	-10.5875	-19.3177
0.704	19.5809	-10.1383	-25.3654	-0.9804	-0.2772	16.4903	-9.2589	-30.1605	22.6716	-11.0178	-20.5702
0.72	19.6995	-9.8624	-25.345	-0.9786	-0.2807	16.6837	-8.9929	-30.0109	22.7153	-10.732	-20.6791
0.736	19.066	-9.8432	-25.9743	-0.9485	-0.2709	15.8785	-8.958	-30.5854	22.2535	-10.7283	-21.3632
0.752	19.3841	-10.2191	-26.8701	-0.9913	-0.2973	16.2456	-9.2574	-31.8854	22.5226	-11.1809	-21.8548
0.768	19.9649	-10.2268	-27.2989	-1.0128	-0.2789	17.0284	-9.386	-32.193	22.9014	-11.0677	-22.4048
0.784	19.9592	-10.3993	-28.1571	-0.9786	-0.3195	17.0065	-9.4225	-32.7799	22.9119	-11.3761	-23.5344
0.8	19.5933	-10.21	-28.2541	-0.9039	-0.3482	16.9333	-9.0485	-32.5789	22.7933	-11.3715	-23.9293
0.816	20.0385	-10.4419	-29.2026	-0.8919	-0.3637	16.9054	-9.2493	-33.3576	23.1715	-11.6345	-25.0475
0.832	19.8067	-10.4699	-29.8241	-0.8046	-0.3546	16.2757	-9.1626	-33.7371	23.3377	-11.7771	-25.9112
0.848	19.3521	-10.5472	-30.4633	-0.7998	-0.3735	16.2563	-9.3339	-33.8859	22.448	-11.7606	-27.0407
0.864	19.1926	-10.9633	-31.7613	-0.7053	-0.3662	15.4644	-9.5337	-35.1609	22.9208	-12.3929	-28.3617
0.88	19.2346	-10.7938	-32.2436	-0.6788	-0.3905	15.6083	-9.3011	-35.407	22.8608	-12.2865	-29.0802
0.896	20.1525	-10.8751	-32.8038	-0.645	-0.3199	15.9178	-9.4722	-36.16	24.3873	-12.278	-29.4477
0.912	19.7776	-11.2467	-34.3444	-0.6271	-0.3525	15.6567	-9.7307	-37.5262	23.8986	-12.7626	-31.1625
0.928	19.4001	-11.1657	-34.7546	-0.5102	-0.358	15.2248	-9.6035	-37.2496	23.5754	-12.7279	-32.2595
0.944	19.391	-10.9236	-35.1932	-0.334	-0.349	14.7541	-9.2363	-36.9053	24.028	-12.6109	-33.4811
0.96	19.1232	-10.9412	-35.7104	-0.3325	-0.3808	14.4968	-9.0891	-37.4313	23.7496	-12.7932	-33.9895
0.976	19.7847	-11.167	-36.7489	-0.3172	-0.3439	15.3021	-9.5615	-38.3119	24.2673	-12.7726	-35.1858
0.992	20.0934	-11.0403	-36.8027	-0.2515	-0.3163	15.0427	-9.3873	-38.1682	25.1441	-12.6932	-35.4371
1.008	19.9222	-11.0129	-37.3873	-0.1986	-0.3261	15.1444	-9.3972	-38.4022	24.7001	-12.6285	-36.3724
1.024	20.0909	-10.8516	-37.8298	0.0587	-0.7221	16.4584	-7.6519	-37.5455	23.7234	-12.0513	-38.1142
1.04	20.4016	-11.0184	-38.7223	-0.0075	-0.5391	16.7309	-8.8226	-38.7541	24.0724	-13.2143	-38.6904
1.056	20.4489	-11.3794	-39.6783	-0.0173	-0.5636	16.4576	-8.8569	-39.7601	24.4402	-13.9018	-39.5964
1.072	20.1562	-11.5029	-40.4497	0.1023	-0.6209	16.5884	-8.9507	-39.9992	23.7241	-14.0551	-40.9003
1.088	20.5791	-11.6853	-41.644	0.0802	-0.6007	17.0058	-9.2366	-41.2958	24.1525	-14.1339	-41.9923
1.104	19.9061	-11.3128	-41.3889	-0.0814	-0.4926	15.8436	-9.1321	-41.7649	23.9685	-13.4935	-41.0129
1.12	19.8965	-11.4482	-42.4319	0.0485	-0.4737	16.0855	-9.4945	-42.2241	23.7075	-13.402	-42.6398
1.136	20.6497	-11.9427	-43.7039	0.0451	-0.5157	17.3589	-10.0774	-43.5332	23.9406	-13.808	-43.8746
1.152	20.4326	-11.6402	-43.7855	0.215	-0.6172	17.0144	-9.2146	-42.8704	23.8507	-14.0658	-44.7007
1.168	20.6726	-11.356	-44.346	0.2786	-0.7362	17.6348	-8.6031	-43.1731	23.7105	-14.1089	-45.5188
1.184	20.5505	-11.9291	-44.9641	0.3163	-0.8708	18.1776	-9.1119	-43.7587	22.9234	-14.7464	-46.1695
1.2	21.0272	-11.4715	-45.2316	0.4292	-0.9329	18.7295	-8.3717	-43.4659	23.3249	-14.5712	-46.9972
1.216	20.1916	-12.1929	-46.2321	0.3853	-0.7334	17.1773	-9.477	-44.5864	23.2058	-14.9087	-47.8779
1.232	19.7507	-11.8234	-46.4724	0.3999	-0.6801	15.9395	-8.7409	-44.4007	23.562	-14.9059	-48.5441
1.248	19.1305	-12.25	-47.8632	0.4093	-0.6738	15.2011	-9.1122	-45.6817	23.0599	-15.3878	-50.0448
1.264	19.5391	-12.1245	-48.0901	0.3901	-0.5593	14.8779	-9.2068	-45.8288	24.2003	-15.0422	-50.3514
1.28	18.5223	-12.8559	-49.3391	0.4097	-0.6017	14.1343	-9.8431	-47.0272	22.9103	-15.8687	-51.6509
1.296	19.0772	-12.5149	-49.5502	0.5196	-0.6955	14.7894	-8.9366	-46.3557	23.3649	-16.0932	-52.7447
1.312	19.101	-13.0521	-50.3281	0.4177	-0.6176	14.5127	-9.7929	-47.8305	23.6893	-16.3114	-52.8258
1.328	18.8166	-13.1075	-50.8592	0.47	-0.7008	14.5752	-9.529	-48.0403	23.058	-16.686	-53.6781
1.344	19.2805	-13.4137	-51.5776	0.4317	-0.6047	14.6394	-10.2063	-48.9787	23.9217	-16.6211	-54.1764
1.36	19.0968	-13.5239	-52.4781	0.4975	-0.66	14.605	-10.038	-49.39	23.5886	-17.0099	-55.5661
1.376	19.2344	-13.6004	-52.9933	0.4983	-0.7542	15.6975	-10.2776	-50.3527	22.7713	-16.9231	-55.6338
1.392	18.8287	-14.063	-53.6033	0.4933	-0.7483	14.954	-10.4656	-50.7608	22.7034	-17.6603	-56.4457
1.408	19.3316	-14.258	-54.1734	0.4417	-0.6929	15.2499	-10.8695	-51.6649	23.4133	-17.6465	-56.682
1.424	18.9294	-14.2704	-54.6551	0.4789	-0.6782	14.6743	-10.8422	-51.8183	23.1845	-17.6986	-57.492
1.44	18.6593	-14.8237	-55.689	0.4985	-0.727	14.3407	-10.9823	-52.5427	22.9778	-18.6652	-58.8353

Rock5

time	pos(x)	pos(y)	pos(z)	el	az	x1	y1	z1	x2	y2	z2
1.456	19.0651	-14.6611	-56.4404	0.4628	-0.7238	14.7849	-10.8779	-53.59	23.3454	-18.4444	-59.2908
1.472	19.0811	-14.905	-57.0378	0.4266	-0.743	14.7923	-10.9657	-54.3914	23.3698	-18.8443	-59.6843
1.488	18.4545	-14.9924	-57.7724	0.4228	-0.7439	14.1523	-11.0333	-55.1421	22.7567	-18.9516	-60.4028
1.504	20.9585	-14.8655	-58.7711	0.4149	-1.0526	18.7931	-11.0675	-56.8451	23.1239	-18.6636	-60.697
1.52	19.7916	-15.0339	-58.991	0.3507	-1.3494	18.9449	-11.2726	-57.5808	20.6384	-18.7951	-60.4013
1.536	20.0356	-15.209	-59.567	0.358	-1.5131	19.8304	-11.6572	-58.2361	20.2407	-18.7608	-60.8978
1.552	20.434	-15.1836	-59.9976	0.3016	-1.6243	20.6244	-11.626	-58.8892	20.2436	-18.7412	-61.106
1.568	20.5763	-15.6811	-61.0446	0.3812	-1.7247	21.192	-11.7105	-59.4342	19.9605	-19.6518	-62.655
1.584	20.3061	-16.4584	-62.0427	0.3316	-1.6723	20.6994	-12.5983	-60.7067	19.9127	-20.3185	-63.3788
1.6	20.3813	-16.2375	-62.3314	0.2909	-1.6332	20.6054	-12.6491	-61.2551	20.1572	-19.826	-63.4077
1.616	21.0326	-16.3685	-62.9116	0.2943	-1.6779	21.4166	-12.7961	-61.8227	20.6486	-19.9409	-64.0005
1.632	20.7695	-16.8193	-63.8388	0.1433	-1.7302	21.3958	-12.9233	-63.2693	20.1432	-20.7154	-64.4082
1.648	20.6807	-17.3282	-64.4941	0.17	-1.8973	22.06	-13.2546	-63.7559	19.3014	-21.4019	-65.2322
1.664	22.049	-17.0559	-65.4886	0.2484	-1.6571	22.3859	-13.1652	-64.4971	21.7122	-20.9529	-66.48
1.68	21.8187	-17.2762	-66.2792	0.222	-1.7024	22.3269	-13.4388	-65.4056	21.3106	-21.1136	-67.1528
1.696	21.9807	-17.4664	-66.6327	0.1906	-1.6591	22.3052	-13.7994	-65.9225	21.6561	-21.1333	-67.3429
1.712	21.9444	-18.0689	-67.4367	0.196	-1.76	22.733	-13.9512	-66.6043	21.1558	-22.1865	-68.2691
1.728	22.0466	-18.1953	-67.7428	0.1312	-1.797	22.9558	-14.245	-67.208	21.1375	-22.1457	-68.2776
1.744	22.0384	-18.4634	-68.8645	0.1843	-1.8221	23.0995	-14.3305	-68.0693	20.9773	-22.5963	-69.6598
1.76	22.756	-18.5865	-69.3751	0.0715	-1.7817	23.5709	-14.7801	-69.0964	21.9411	-22.3928	-69.6539
1.776	23.0845	-18.9024	-70.1656	0.0475	-1.8012	23.979	-15.0883	-69.9795	22.19	-22.7165	-70.3517
1.792	22.5489	-19.0559	-70.6134	-0.0126	-1.8775	23.6886	-15.4571	-70.6609	21.4092	-22.6547	-70.5658
1.808	22.5504	-19.1449	-71.5354	-0.0585	-1.8909	23.8366	-15.2647	-71.7748	21.2642	-22.0251	-71.2961
1.824	22.7542	-19.0178	-71.7982	-0.1718	-1.9337	24.0776	-15.5323	-72.4451	21.4308	-22.5033	-71.1512
1.84	22.4364	-19.8986	-73.3023	-0.319	-1.78	23.1101	-16.7258	-74.3737	21.7626	-23.0714	-72.2309
1.856	22.7671	-20.1909	-73.9225	-0.2835	-1.9295	23.9099	-17.1425	-74.8711	21.6242	-23.2392	-72.9738
1.872	22.7443	-20.1416	-74.4721	-0.223	-1.9794	24.1492	-16.897	-75.2739	21.3394	-23.3861	-73.6703
1.888	23.0298	-20.2495	-74.6298	-0.3827	-2.037	24.5662	-17.1962	-76.0059	21.4935	-23.3027	-73.2537
1.904	22.7978	-20.3118	-75.3208	-0.3865	-2.0561	24.3711	-17.3283	-76.6934	21.2244	-23.2953	-73.9482
1.92	23.0418	-20.6316	-76.2773	-0.4977	-2.1291	24.813	-17.7956	-78.0938	21.2706	-23.4675	-74.4608
1.936	23.4572	-20.5517	-77.0332	-0.3232	-2.1332	25.493	-17.3217	-78.3121	21.4215	-23.7818	-75.7543
1.952	23.0801	-20.5974	-77.0292	-0.44	-2.1901	25.2039	-17.6179	-78.7519	20.9563	-23.577	-75.3065
1.968	23.087	-20.7803	-77.7688	-0.4606	-2.2202	25.4103	-17.7204	-79.6751	20.7637	-23.8401	-75.8625
1.984	23.5149	-20.4848	-77.9434	-0.449	-2.2231	25.6973	-17.6276	-79.6758	21.3326	-23.3421	-76.2109
2	23.3675	-20.4815	-78.5732	-0.5096	-2.331	26.0798	-17.629	-80.7727	20.6552	-23.3339	-76.3736
2.016	23.8901	-20.3771	-79.2	-0.4646	-2.3194	26.4774	-17.5919	-81.105	21.3028	-23.1623	-77.295
2.032	23.6924	-21.0624	-80.326	-0.4328	-2.2763	26.2392	-18.0722	-82.1405	21.1457	-24.0525	-78.5116
2.048	23.7323	-21.0176	-80.9825	-0.4595	-2.3498	26.6627	-18.0496	-83.0464	20.8018	-23.9857	-78.9185
2.064	24.0041	-22.0224	-82.5754	-0.3364	-2.3013	26.7657	-18.9398	-84.0227	21.2425	-25.105	-81.1281
2.08	24.3331	-21.8383	-83.0516	-0.2291	-2.2676	26.9599	-18.6992	-84.006	21.7063	-24.9774	-82.0972
2.096	23.6995	-22.109	-83.3674	-0.2639	-2.326	26.6552	-18.9693	-84.5326	20.7438	-25.2488	-82.2022
2.112	24.4195	-22.5026	-84.5304	-0.3125	-2.3209	27.3056	-19.4053	-85.8983	21.5334	-25.5999	-83.1625
2.128	24.595	-22.408	-85.2066	-0.28	-2.3496	27.775	-19.1861	-86.5085	21.415	-25.6299	-83.9046
2.144	24.4732	-22.7425	-86.1136	-0.272	-2.3679	27.5829	-19.7047	-87.3263	21.3636	-25.7802	-84.901
2.16	24.0955	-22.9375	-86.8179	-0.2559	-2.2624	26.8144	-19.6536	-87.9332	21.3766	-26.2214	-85.7025
2.176	24.6007	-23.2042	-87.7974	-0.2989	-2.2897	27.4845	-19.9089	-89.1467	21.7168	-26.4994	-86.4481
2.192	24.6256	-23.2978	-88.3805	-0.4046	-2.3194	27.3815	-20.3313	-90.1145	21.8698	-26.2643	-86.6466
2.208	24.8518	-23.0142	-88.839	-0.4003	-2.3693	27.9062	-20.0386	-90.6436	21.7974	-25.9898	-87.0344
2.224	24.5756	-23.8479	-89.9279	-0.3208	-2.2575	27.127	-20.7355	-91.2651	22.0243	-26.9602	-88.5907
2.24	24.9229	-23.6524	-90.6875	-0.2935	-2.2628	27.5906	-20.4336	-91.9512	22.2553	-26.8713	-89.4239
2.256	25.0143	-23.7914	-91.5362	-0.2578	-2.2636	27.851	-20.3741	-92.7074	22.1775	-27.2086	-90.3649
2.272	25.5494	-24.06	-92.1596	-0.2267	-2.188	28.0472	-20.5406	-93.155	23.0515	-27.5793	-91.1642
2.288	25.3303	-23.9976	-92.8826	-0.356	-2.1625	27.4264	-20.8783	-94.2802	23.2343	-27.1169	-91.4851
2.304	25.2157	-24.2877	-93.723	-0.3165	-2.1733	27.6951	-20.6829	-95.1562	22.7364	-27.8926	-92.2899
2.32	25.0861	-24.1858	-94.1211	-0.244	-2.0991	27.2076	-20.5507	-95.1689	22.9647	-27.8208	-93.0733
2.336	25.2434	-24.1049	-95.0519	-0.1838	-2.0481	27.2171	-20.2889	-95.8504	23.2696	-27.9209	-94.2533
2.352	25.7371	-24.2399	-96.0511	-0.1915	-2.0609	27.626	-20.6997	-96.829	23.8483	-27.7801	-95.2731
2.368	24.9277	-24.8878	-96.9663	-0.0512	-1.9958	26.836	-20.6716	-97.2035	23.0194	-29.1041	-96.7292
2.384	25.5912	-24.878	-97.9266	-0.0941	-1.9933	27.4385	-20.7693	-98.352	23.744	-28.9868	-97.5012
2.4	25.5751	-24.9609	-98.401	-0.0881	-1.9486	27.1206	-21.0661	-98.7713	24.0295	-28.8556	-98.0308
2.416	25.1988	-25.2944	-99.1607	-0.0295	-1.8954	26.7037	-20.8216	-99.2999	23.6939	-29.7673	-99.0216
2.432	25.29	-25.1616	-99.7207	-0.0547	-1.8352	26.4226	-20.9782	-99.9579	24.1574	-29.3451	-99.4836
2.448	25.4454	-25.6098	-100.5625	-0.0529	-1.8405	26.5661	-21.555	-100.7854	24.3247	-29.6646	-100.3395
2.464	25.2311	-25.6472	-100.8453	-0.0407	-1.8021	26.2599	-21.2799	-101.0279	24.2024	-30.0146	-100.6626
2.48	25.3166	-25.6878	-101.9092	0.0546	-1.7699	26.2806	-20.9116	-101.643	24.3526	-30.4641	-102.1754
2.496	24.9481	-25.8513	-102.6679	0.0504	-1.7976	26.0183	-21.215	-102.4276	23.878	-30.4876	-102.9081

Rock5

time	pos(x)	pos(y)	pos(z)	el	az	x1	y1	z1	x2	y2	z2
2.512	25.2914	-25.8523	-103.4308	-0.0122	-1.6641	25.6855	-21.6399	-103.4823	24.8973	-30.0646	-103.3793
2.528	24.6054	-25.6418	-103.911	0.0061	-1.6473	24.9346	-21.3445	-103.8849	24.2762	-29.9391	-103.9372
2.544	24.7446	-26.3032	-104.92	0.0618	-1.7222	25.4637	-21.5918	-104.6252	24.0256	-31.0145	-105.2148
2.56	24.1475	-26.6279	-106.013	0.1695	-1.5847	24.2147	-21.7802	-105.183	24.0803	-31.4756	-106.843
2.576	24.4443	-25.8823	-105.9262	0.2231	-1.5463	24.3214	-20.8677	-104.788	24.5672	-30.897	-107.0645
2.592	24.2591	-25.8989	-106.5463	0.3021	-1.5971	24.4116	-20.1063	-104.7404	24.1067	-31.6914	-108.3521
2.608	23.8948	-26.5481	-107.6426	0.3734	-1.5465	23.7597	-20.977	-105.4591	24.0299	-32.1193	-109.8261
2.624	23.83	-26.1381	-107.6748	0.4125	-1.5366	23.6526	-20.9573	-105.4061	24.0074	-31.3189	-109.9434
2.64	24.0095	-26.5675	-108.5526	0.4202	-1.498	23.6414	-21.5205	-106.2917	24.3776	-31.6146	-110.8134
2.656	24.2161	-27.0643	-109.7668	0.5101	-1.5945	24.3454	-21.5984	-106.7078	24.0867	-32.5302	-112.8258
2.672	23.3088	-26.7694	-109.8492	0.5059	-1.534	23.0986	-21.0598	-106.684	23.519	-32.4791	-113.0144
2.688	23.8349	-27.0083	-110.7791	0.5488	-1.5622	23.7875	-21.4833	-107.4009	23.8823	-32.5332	-114.1573
2.704	23.6401	-26.6606	-110.3217	0.5626	-1.5125	23.3678	-21.9981	-107.3765	23.9124	-31.3231	-113.267
2.72	23.8676	-27.2419	-111.5965	0.5536	-1.579	23.9121	-21.7911	-108.2274	23.8231	-32.6927	-114.9655
2.736	24.1727	-26.918	-111.5958	0.57	-1.4344	23.5188	-22.1519	-108.5123	24.8266	-31.6841	-114.6793
2.752	23.902	-26.8733	-112.0449	0.5552	-1.5944	24.0328	-21.3415	-108.6127	23.7713	-32.405	-115.4771
2.768	23.6046	-27.0899	-112.7414	0.6514	-1.4401	22.9675	-22.2438	-109.0149	24.2417	-31.9361	-116.4679
2.784	23.5601	-27.7832	-114.3425	0.6722	-1.5753	23.5842	-22.4637	-110.1091	23.5359	-33.1027	-118.576
2.8	23.7484	-26.9201	-114.0419	0.6851	-1.4482	23.1035	-21.6878	-109.7342	24.3933	-32.1524	-118.3497
2.816	23.6378	-26.8269	-114.4775	0.6411	-1.5723	23.6465	-21.1991	-110.278	23.6292	-32.4547	-118.6771
2.832	22.0008	-27.2567	-115.4148	0.6764	-1.3331	20.6144	-21.5353	-110.6888	23.3873	-32.9781	-120.1408
2.848	21.353	-27.2163	-115.9104	0.6989	-1.1871	19.0856	-21.5997	-110.8198	23.6205	-32.833	-121.0009
2.864	22.2792	-28.3155	-117.1762	0.7363	-1.3747	21.1523	-22.6421	-111.934	23.4061	-33.9889	-122.4183
2.88	22.5044	-28.1855	-117.8685	0.7649	-1.3439	21.2741	-22.8558	-112.6182	23.7348	-33.5153	-123.1189
2.896	21.1791	-28.8561	-118.4665	0.7393	-1.2851	19.4688	-23.0342	-112.9341	22.8893	-34.6781	-123.9989
2.912	21.9317	-28.3573	-118.8415	0.7514	-1.343	20.6227	-22.71	-113.4253	23.2407	-34.0047	-124.2576
2.928	21.9818	-29.0253	-120.5926	0.7576	-1.2922	20.3714	-23.3964	-115.0545	23.5921	-34.6541	-126.1308
2.944	21.6542	-28.5607	-120.814	0.7384	-1.3835	20.6192	-23.0997	-115.755	22.6891	-34.0218	-125.873
2.96	22.1205	-29.2076	-122.2313	0.7715	-1.2894	20.5002	-23.6025	-116.5561	23.7409	-34.8127	-127.9064
2.976	22.022	-28.9549	-122.6872	0.7985	-1.3068	20.6906	-24.0299	-117.4496	23.3534	-33.8798	-127.9247
2.992	21.2052	-29.7814	-123.7519	0.8194	-1.4148	20.3482	-24.3325	-117.8477	22.0621	-35.2303	-129.6561
3.008	21.0172	-29.953	-124.4799	0.8109	-1.3562	19.9015	-24.8352	-118.9681	22.1328	-35.0708	-129.9918
3.024	21.64	-29.635	-125.0982	0.8317	-1.4339	20.9706	-24.7772	-119.7183	22.3094	-34.4928	-130.478
3.04	21.279	-30.9684	-126.5307	0.769	-1.4703	20.6838	-25.0676	-120.7914	21.8742	-36.8693	-132.27
3.056	21.8155	-30.1177	-127.4237	0.7674	-1.4703	21.2528	-24.5391	-122.0151	22.3781	-35.6963	-132.8323
3.072	22.1458	-30.9492	-128.4829	0.7603	-1.532	21.9413	-25.687	-123.4746	22.3503	-36.2114	-133.4912
3.088	21.8359	-31.1805	-129.2593	0.7299	-1.4785	21.3249	-25.6596	-124.2983	22.3469	-36.7015	-134.2203
3.104	22.192	-31.8284	-130.3673	0.7679	-1.467	21.6271	-26.4063	-125.1034	22.757	-37.2505	-135.6311
3.12	21.4623	-31.4918	-130.6727	0.7243	-1.4621	20.914	-26.4669	-126.2008	22.0106	-36.5167	-135.1446
3.136	21.4401	-31.9653	-131.7527	0.6907	-1.5175	21.1572	-26.6588	-127.361	21.7231	-37.2718	-136.1444
3.152	21.3864	-32.6604	-133.0065	0.688	-1.5819	21.4471	-27.1906	-128.5103	21.3257	-38.1301	-137.5027
3.168	21.7497	-33.0941	-134.0853	0.6539	-1.5366	21.5731	-27.927	-130.1232	21.9262	-38.2612	-138.0475
3.184	21.5346	-33.7496	-134.8976	0.6406	-1.6398	21.9189	-28.1894	-130.7427	21.1503	-39.3098	-139.0525
3.2	21.8554	-34.5729	-135.9976	0.6477	-1.5088	21.4831	-28.5788	-131.4539	22.2277	-40.567	-140.5413
3.216	21.7589	-34.4701	-136.6336	0.589	-1.5545	21.6666	-28.8027	-132.8464	21.8512	-40.1376	-140.4208
3.232	22.0569	-34.64	-137.1319	0.6032	-1.464	21.5118	-29.5565	-133.6097	22.602	-39.7236	-140.6541
3.248	22.4682	-34.9778	-138.2345	0.5431	-1.6248	22.7974	-28.8865	-134.5517	22.139	-41.0691	-141.9172
3.264	22.6165	-35.4574	-139.3464	0.451	-1.6879	23.3402	-29.3087	-136.3478	21.8929	-41.6061	-142.3449
3.28	22.4772	-36.5304	-140.1514	0.4611	-1.7021	23.3004	-30.2956	-137.0272	21.6539	-42.7652	-143.2757
3.296	22.9364	-36.2556	-140.9393	0.4882	-1.7179	23.839	-30.1659	-137.6698	22.0339	-42.3453	-144.2089
3.312	22.4048	-37.5039	-141.3679	0.4252	-1.7241	23.3056	-31.6754	-138.6972	21.5039	-43.3323	-144.0387
3.328	22.3804	-36.8999	-141.8117	0.4393	-1.7563	23.4216	-31.3533	-139.1598	21.3393	-42.4464	-144.4636
3.344	22.766	-37.6808	-142.4607	0.3607	-1.7773	24.051	-31.5454	-140.096	21.4809	-43.8163	-144.8254
3.36	23.285	-38.334	-143.1465	0.3759	-1.8526	25.0446	-32.2562	-140.6489	21.5253	-44.4118	-145.644
3.376	23.1041	-38.6443	-143.4919	0.3227	-1.8705	24.8364	-33.0387	-141.5302	21.3717	-44.2499	-145.4536
3.392	23.4893	-38.166	-143.2063	0.2723	-1.8506	24.9351	-33.1338	-141.7442	22.0435	-43.1982	-144.6685
3.408	22.7767	-39.9764	-145.5725	0.2696	-1.8731	24.6516	-33.964	-143.8325	20.9018	-45.9887	-147.3126
3.424	23.9591	-40.3933	-145.9407	0.2929	-2.0428	26.899	-34.6342	-143.9905	21.0192	-46.1524	-147.8908
3.44	23.4569	-41.1377	-146.1066	0.2572	-2.0387	26.4949	-35.1252	-144.3348	20.4189	-47.1501	-147.8785
3.456	23.3866	-42.0099	-146.6546	0.2369	-2.0239	26.2098	-36.2107	-145.0973	20.5634	-47.8091	-148.212
3.472	22.9789	-43.0074	-147.8416	0.2852	-1.9958	25.5635	-37.2959	-146.0033	20.3942	-48.7188	-149.6799
3.488	23.1309	-43.9695	-148.1139	0.2723	-2.0209	25.7477	-38.554	-146.4342	20.5142	-49.385	-149.7936
3.504	22.8528	-44.2819	-148.5298	0.1569	-2.0492	25.4032	-39.3637	-147.6535	20.3023	-49.2001	-149.4061
3.52	22.4419	-44.4858	-148.9957	0.0241	-2.1059	25.2502	-39.7487	-148.8628	19.6336	-49.223	-149.1286
3.536	21.884	-45.4572	-149.4823	-0.0419	-2.0945	24.9384	-40.1686	-149.7382	18.8296	-50.7459	-149.2264
3.552	21.7394	-46.1764	-150.2017	-0.0943	-2.0751	24.5584	-41.0685	-150.7533	18.9205	-51.2843	-149.6502

Rock5

time	pos(x)	pos(y)	pos(z)	el	az	x1	y1	z1	x2	y2	z2
3.568	21.7655	-46.0777	-150.773	-0.1463	-2.1003	24.6848	-41.0895	-151.6244	18.8461	-51.0659	-149.9216
3.584	21.5868	-46.3292	-151.5671	-0.1735	-2.1142	24.4543	-41.5826	-152.5393	18.7193	-51.0759	-150.595
3.6	21.7094	-46.4398	-152.0462	-0.156	-2.1171	24.6475	-41.6081	-152.9356	18.7714	-51.2714	-151.1568
3.616	21.5402	-47.1026	-152.6902	-0.23	-2.0866	24.2576	-42.3104	-153.9799	18.8229	-51.8947	-151.4005
3.632	21.295	-47.5927	-153.4039	-0.1989	-2.0918	24.1643	-42.5929	-154.5657	18.4258	-52.5926	-152.2421
3.648	20.9713	-47.7544	-154.0641	-0.3648	-2.0695	23.4214	-43.2553	-156.0203	18.5212	-52.2536	-152.108
3.664	20.8972	-47.6691	-153.924	-0.3342	-2.0747	23.2531	-43.396	-155.6183	18.5412	-51.9423	-152.2298
3.68	20.6752	-47.7067	-154.7937	-0.4019	-2.089	23.0901	-43.4709	-156.8663	18.2602	-51.9425	-152.7212
3.696	20.5826	-48.2851	-155.7068	-0.4635	-2.0338	22.5928	-44.2588	-157.9561	18.5725	-52.3115	-153.4576
3.712	20.2859	-48.562	-156.5214	-0.4877	-2.0717	22.3503	-44.7912	-158.8018	18.2214	-52.3328	-154.2411
3.728	19.6954	-49.503	-156.9844	-0.5147	-2.0025	21.4019	-45.7985	-159.291	17.9889	-53.2075	-154.6778
3.744	19.9164	-48.8029	-158.0362	-0.5135	-1.9776	21.7771	-44.4846	-160.6881	18.0557	-53.1213	-155.3842
3.76	19.5361	-49.1781	-158.6996	-0.5666	-1.9875	21.3187	-45.1509	-161.5017	17.7535	-53.2053	-155.8975
3.776	19.2116	-49.6591	-158.528	-0.5751	-1.8849	20.5395	-45.5707	-161.3144	17.8836	-53.7475	-155.7417
3.792	18.9489	-49.3215	-158.9355	-0.4269	-1.8736	20.5521	-44.1902	-161.381	17.3456	-54.4528	-156.49
3.808	19.1882	-48.138	-159.2264	-0.6685	-1.8468	20.2683	-44.3243	-162.3567	18.1081	-51.9518	-156.096
3.824	18.9375	-50.5899	-160.2912	-0.6227	-1.7904	19.7473	-46.9621	-162.9598	18.1276	-54.2177	-157.6225
3.84	18.5547	-51.2787	-160.3573	-0.6637	-1.8204	19.4499	-47.7669	-163.1915	17.6594	-54.7904	-157.5232
3.856	18.559	-50.8657	-160.7764	-0.4586	-1.7558	19.4551	-46.0762	-163.1821	17.6628	-55.6552	-158.3707
3.872	18.6195	-50.1965	-161.4998	-0.3805	-1.7432	19.4344	-45.5172	-163.3995	17.8045	-54.8759	-159.6
3.888	18.311	-51.6282	-161.8163	-0.3265	-1.751	19.2027	-46.7338	-163.501	17.4193	-56.5226	-160.1316
3.904	18.3848	-50.7653	-162.5824	-0.2294	-1.728	19.2944	-45.0264	-163.9392	17.4753	-56.5042	-161.2256
3.92	18.3124	-51.5067	-163.2826	-0.174	-1.7786	19.6877	-44.9825	-164.4546	16.9371	-58.031	-162.1105
3.936	18.3389	-51.6431	-163.8131	-0.2099	-1.7379	19.1852	-46.6254	-164.8972	17.4926	-56.6607	-162.729
3.952	18.0722	-52.2451	-164.1399	0.0001	-1.7133	18.7489	-47.5303	-164.1394	17.3955	-56.96	-164.1404
3.968	17.9595	-51.5076	-164.2442	0.1043	-1.6809	18.5602	-46.0718	-163.6719	17.3588	-56.9435	-164.8165
3.984	18.1042	-52.0318	-165.2487	0.0597	-1.7281	19.2149	-45.0277	-164.8246	16.9935	-59.0358	-165.6729
4	18.1538	-51.4563	-165.6889	0.2043	-1.7311	19.1834	-45.0899	-164.3525	17.1242	-57.8226	-167.0252
4.016	17.8764	-51.7082	-165.4691	0.0445	-1.7483	19.1642	-44.5289	-165.1444	16.5886	-58.8875	-165.7938
4.032	17.8698	-51.6413	-165.9188	0.0787	-1.7344	19.1748	-43.7335	-165.2866	16.5647	-59.5491	-166.5511
4.048	17.9679	-51.9229	-166.9053	0.061	-1.7305	19.2568	-43.9207	-166.41	16.6789	-59.925	-167.4005
4.064	18.1246	-50.9589	-167.4769	0.1285	-1.7325	19.2925	-43.7991	-166.5397	16.9566	-58.1187	-168.414
4.08	17.7186	-50.8981	-168.1671	0.163	-1.7044	18.7304	-43.37	-166.9176	16.7069	-58.4262	-169.4166
4.096	17.548	-50.9016	-167.9273	0.1975	-1.6053	17.8113	-43.276	-166.4007	17.2848	-58.5273	-169.4539
4.112	17.3672	-51.8608	-168.3611	0.2859	-1.6839	18.2101	-44.4403	-166.1661	16.5244	-59.2812	-170.556
4.128	17.0521	-51.7197	-168.9602	0.3035	-1.649	17.5968	-44.7689	-166.7766	16.5074	-58.6704	-171.1437
4.144	17.1725	-52.5314	-169.7383	0.3181	-1.6526	17.7601	-45.3604	-167.3691	16.5849	-59.7023	-172.1076
4.16	17.0623	-53.2927	-170.487	0.3623	-1.6285	17.4619	-46.3726	-167.8598	16.6628	-60.2129	-173.1142
4.176	17.2209	-52.9312	-171.4577	0.3818	-1.6329	17.6511	-46.0105	-168.6737	16.7907	-59.8519	-174.2417
4.192	16.9999	-52.6603	-171.6525	0.3976	-1.6073	17.2309	-46.3382	-168.9958	16.769	-58.9825	-174.3092
4.208	17.0547	-53.5329	-172.2901	0.3785	-1.6472	17.5567	-46.979	-169.6765	16.5528	-60.0867	-174.9038
4.224	17.1922	-53.0442	-173.1324	0.4297	-1.5983	17.3675	-46.6789	-170.214	17.0169	-59.4095	-176.0508
4.24	17.0875	-53.5939	-173.7128	0.4461	-1.5604	17.0243	-47.525	-170.8101	17.1506	-59.6629	-176.6155
4.256	17.2671	-53.4097	-174.2574	0.4514	-1.5643	17.2283	-47.4435	-171.3647	17.3058	-59.3759	-177.15
4.272	17.1253	-54.0987	-175.095	0.4573	-1.5621	17.0712	-47.8613	-172.0253	17.1794	-60.3361	-178.1648
4.288	17.0152	-54.3761	-175.6336	0.4992	-1.5273	16.7933	-49.2785	-172.8517	17.2371	-59.4736	-178.4154
4.304	16.9469	-54.3893	-176.0207	0.4649	-1.577	16.9817	-48.8005	-173.2174	16.9122	-59.9781	-178.8239
4.32	17.0515	-54.2972	-176.8239	0.4869	-1.5127	16.7336	-48.8341	-173.9269	17.3695	-59.7604	-179.7208
4.336	17.3525	-54.5168	-176.9665	0.4291	-1.5903	17.4682	-48.5941	-174.2565	17.2368	-60.4395	-179.6765
4.352	17.5419	-54.1648	-177.9079	0.4071	-1.5502	17.4325	-48.8548	-175.6178	17.6514	-59.4747	-180.198
4.368	17.3649	-55.1705	-178.7403	0.3879	-1.6646	17.963	-48.8153	-176.1324	16.7668	-61.5256	-181.3482
4.384	17.293	-56.3073	-179.6829	0.2871	-1.6186	17.6056	-49.7739	-177.7519	16.9805	-62.8408	-181.6138
4.4	17.7848	-55.503	-179.8443	0.1767	-1.6287	18.2015	-48.3197	-178.5597	17.3681	-62.6862	-181.1289
4.416	17.8673	-55.2628	-180.5253	0.242	-1.6435	18.3331	-48.8696	-178.9434	17.4015	-61.656	-182.1073
4.432	17.8632	-55.8965	-181.1301	0.2355	-1.6788	18.5827	-49.2628	-179.5293	17.1437	-62.5302	-182.7309
4.448	18.0793	-56.3146	-181.7434	0.2295	-1.6264	18.462	-49.4394	-180.1351	17.6966	-63.1898	-183.3517
4.464	17.6501	-56.3192	-181.7279	0.2151	-1.5411	17.4453	-49.4226	-180.2205	17.8549	-63.2159	-183.2354
4.48	17.7264	-55.9844	-182.069	0.1416	-1.5529	17.5972	-48.7623	-181.0392	17.8556	-63.2064	-183.0988
4.496	18.0134	-56.0468	-183.573	0.259	-1.627	18.4377	-48.5069	-181.5725	17.5891	-63.5868	-185.5735
4.512	18.2141	-56.443	-184.2514	0.1623	-1.5316	17.9574	-49.8902	-183.1774	18.4707	-62.9958	-185.3254
4.528	18.4472	-55.7652	-184.4722	0.2084	-1.6781	19.362	-47.2686	-182.6649	17.5324	-64.2617	-186.2796
4.544	17.9937	-57.4764	-185.1784	0.2279	-1.5608	17.9395	-52.0614	-183.9223	18.048	-62.8915	-186.4345
4.56	17.8788	-58.5173	-186.5267	-0.0847	-1.5204	17.6212	-53.4098	-186.9611	18.1365	-63.6248	-186.0922
4.576	17.9968	-58.1807	-186.741	-0.0578	-1.5741	18.0149	-52.7597	-187.0547	17.9787	-63.6016	-186.4273
4.592	18.0738	-59.6152	-187.4879	-0.0863	-1.5946	18.2193	-53.4899	-188.0177	17.9282	-65.7405	-186.958
4.608	17.9625	-59.962	-186.6721	-0.232	-1.5969	18.1132	-54.1886	-188.0364	17.8117	-65.7353	-185.3078

Rock5

time	pos(x)	pos(y)	pos(z)	el	az	x1	y1	z1	x2	y2	z2
4.624	17.6185	-61.301	-188.0762	-0.2559	-1.6699	18.1881	-55.5724	-189.5822	17.049	-67.0296	-186.5702
4.64	17.0371	-61.5631	-188.2176	-0.2267	-1.6523	17.5925	-54.7616	-189.792	16.4817	-68.3646	-186.6432
4.656	17.4183	-61.6191	-188.4508	-0.2115	-1.7017	18.3073	-54.8648	-189.9138	16.5294	-68.3734	-186.9878
4.672	17.4223	-62.2757	-189.4252	-0.2989	-1.6349	17.8178	-56.1162	-191.3267	17.0269	-68.4352	-187.5236
4.688	17.6541	-61.2184	-189.586	-0.3371	-1.6423	18.121	-54.7022	-191.8758	17.1872	-67.7345	-187.2963
4.704	17.2146	-62.8876	-190.4624	-0.3531	-1.652	17.7773	-55.9727	-193.0194	16.6519	-69.8026	-187.9053
4.72	17.6987	-62.2143	-190.8271	-0.4084	-1.6625	18.2684	-56.0172	-193.5201	17.1289	-68.4114	-188.134
4.736	17.3346	-63.2327	-190.8803	-0.3534	-1.6729	18.0039	-56.7011	-193.3019	16.6653	-69.7642	-188.4586
4.752	17.4271	-63.9643	-190.6072	-0.4739	-1.6606	17.9569	-58.0828	-193.636	16.8973	-69.8457	-187.5785
4.768	17.1978	-64.9507	-191.1424	-0.561	-1.5961	17.322	-60.0503	-194.2228	17.0737	-69.8511	-188.062
4.784	16.7321	-66.6094	-191.0019	-0.5114	-1.6635	17.2037	-61.5383	-193.86	16.2606	-71.6805	-188.1439
4.8	16.5688	-67.2724	-191.0987	-0.6289	-1.5498	16.4945	-63.7291	-193.6766	16.643	-70.8156	-188.5209
4.816	16.6084	-67.1435	-191.5427	-0.6016	-1.6064	16.7639	-62.7834	-194.5378	16.453	-71.5036	-188.5475
4.832	16.7181	-66.8279	-192.189	-0.6577	-1.5465	16.6213	-62.8386	-195.2713	16.815	-70.8173	-189.1066
4.848	16.9553	-66.5648	-192.6183	-0.6569	-1.5576	16.9041	-62.681	-195.6137	17.0066	-70.4485	-189.6228
4.864	16.6728	-67.459	-192.813	-0.7374	-1.5555	16.6198	-63.9941	-195.9608	16.7259	-70.9239	-189.6653
4.88	16.6326	-67.4474	-193.6078	-0.7292	-1.5239	16.4812	-64.219	-196.4955	16.7839	-70.6758	-190.7201
4.896	16.5179	-67.2713	-193.8904	-0.8102	-1.4282	16.0771	-64.2018	-197.1493	16.9587	-70.3408	-190.6315
4.912	16.3572	-67.4695	-194.2141	-0.8424	-1.2565	15.4732	-64.7503	-197.4196	17.2413	-70.1888	-191.0085
4.928	16.3958	-67.8781	-194.4753	-0.8696	-1.2291	15.691	-65.8963	-196.9663	17.1006	-69.8598	-191.9843
4.944	16.4596	-68.3215	-195.0776	-0.9045	-1.2248	15.7214	-66.274	-197.8456	17.1978	-70.369	-192.3096
4.96	16.4119	-68.092	-195.445	-0.8939	-1.1006	15.4326	-66.1649	-198.135	17.3912	-70.0191	-192.755
4.976	16.4077	-68.1232	-195.7076	-0.8731	-0.9752	15.2861	-66.4683	-198.0921	17.5294	-69.7782	-193.3231
4.992	16.1884	-68.6213	-196.169	-0.7867	-1.0809	15.1976	-66.7633	-198.2802	17.1792	-70.4794	-194.0579
5.008	16.4335	-67.8032	-197.1566	-0.773	-0.7845	15.0233	-66.3956	-199.1003	17.8437	-69.2109	-195.2129
5.024	16.277	-67.9813	-197.4274	-0.7114	-0.7246	14.8338	-66.7036	-199.0888	17.7203	-69.2589	-195.766
5.04	16.0272	-68.434	-197.9786	-0.6698	-0.5884	14.4758	-67.3989	-199.4554	17.5786	-69.4691	-196.5018
5.056	15.9168	-68.5067	-198.3304	-0.6481	-0.3849	14.1201	-67.7789	-199.7982	17.7134	-69.2344	-196.8627
5.072	16.3279	-68.0087	-199.056	-0.5553	-0.5613	14.5432	-66.8864	-200.364	18.1126	-69.1309	-197.7481
5.088	15.8753	-68.0323	-199.351	-0.5016	-0.7597	14.1909	-66.4323	-200.6251	17.5597	-69.6323	-198.0769
5.104	16.0442	-67.3764	-200.1821	-0.3679	-0.4215	14.0606	-66.487	-201.0202	18.0278	-68.2658	-199.3441
5.12	16.5317	-66.2022	-200.4657	-0.0075	-0.6643	14.8045	-64.8498	-200.4821	18.259	-67.5546	-200.4493
5.136	16.8415	-65.3535	-201.4835	-0.1513	-0.6636	15.0129	-63.9239	-201.8374	18.6701	-66.7831	-201.1295
5.152	16.3143	-66.2568	-201.5135	0.0345	-0.7441	14.5109	-64.5966	-201.4289	18.1178	-67.9171	-201.598
5.168	16.625	-65.543	-201.9113	0.167	-0.41	14.3509	-64.5546	-201.4934	18.899	-66.5313	-202.3293
5.184	16.104	-65.9664	-202.1899	0.1846	-0.7801	14.3628	-64.2436	-201.7324	17.8452	-67.6892	-202.6473
5.2	16.3694	-66.2522	-202.8815	0.2609	-0.6086	14.5533	-64.9867	-202.2906	18.1855	-67.5177	-203.4724
5.216	16.2144	-66.0528	-203.2574	0.3657	-0.4638	14.2552	-65.0729	-202.4186	18.1736	-67.0327	-204.0961
5.232	16.2833	-65.809	-204.2959	0.3043	-0.7017	14.5653	-64.357	-203.5894	18.0012	-67.2609	-205.0024
5.248	16.418	-66.0299	-204.8088	0.379	-0.0011	14.1858	-66.0276	-203.9199	18.6502	-66.0323	-205.6978
5.264	16.4152	-66.1951	-205.1149	0.4443	-0.0898	14.1896	-65.9948	-204.0511	18.6408	-66.3955	-206.1786
5.28	16.1147	-67.4104	-204.6797	0.4841	-0.0405	14.0572	-67.327	-203.5969	18.1721	-67.4939	-205.7625
5.296	16.3541	-66.6476	-206.0936	0.7491	0.1783	14.011	-67.0699	-203.8797	18.6973	-66.2252	-208.3075
5.312	16.3606	-66.6262	-206.5456	0.719	0.1937	13.9407	-67.101	-204.3871	18.7806	-66.1514	-208.7041
5.328	16.4702	-66.7149	-206.8599	0.5644	0.1985	14.0352	-67.2047	-205.2875	18.9051	-66.2252	-208.4323
5.344	16.2335	-67.1995	-207.253	0.6108	0.092	13.9161	-67.4133	-205.6237	18.5509	-66.9857	-208.8822
5.36	16.572	-66.2205	-208.3691	0.626	0.2997	13.9324	-67.0361	-206.3717	19.2116	-65.405	-210.3664
5.376	16.8543	-65.8805	-208.3271	0.5026	0.2367	14.3736	-66.4788	-206.9246	19.335	-65.2822	-209.7297
5.392	16.6715	-66.2252	-208.642	0.5101	0.1819	14.1973	-66.6802	-207.2346	19.1456	-65.7702	-210.0495
5.408	17.0154	-66.1062	-209.5111	0.601	0.3741	14.53	-67.0819	-207.6803	19.5009	-65.1305	-211.3418
5.424	16.9878	-65.837	-209.8601	0.4745	0.2929	14.2567	-66.6605	-208.395	19.7189	-65.0135	-211.3252
5.44	16.8882	-65.7512	-210.6008	0.5312	0.2067	14.2203	-66.3106	-208.9993	19.5561	-65.1917	-212.2024
5.456	17.4753	-64.7412	-211.6827	0.5714	0.2146	14.6665	-65.3534	-209.8345	20.2842	-64.129	-213.531
5.472	17.6047	-64.4713	-212.3891	0.4899	0.2087	14.7642	-65.0727	-210.8407	20.4452	-63.8698	-213.9375
5.488	17.8265	-63.8131	-213.6568	0.4223	0.3591	14.7365	-64.9732	-212.1735	20.9166	-62.6531	-215.14
5.504	18.0135	-63.7874	-213.8447	0.459	0.3635	14.8427	-64.9935	-212.168	21.1843	-62.5812	-215.5213
5.52	18.2729	-63.351	-214.4044	0.4128	0.5364	14.7425	-65.4498	-212.6057	21.8033	-61.5252	-216.203
5.536	18.4712	-62.9342	-214.8583	0.3836	0.454	14.9458	-64.6544	-213.2752	21.9966	-61.214	-216.4414
5.552	18.5924	-62.6498	-215.8111	0.2604	0.399	14.9637	-64.1798	-214.7616	22.2211	-61.1199	-216.8606
5.568	18.4452	-63.1167	-215.2137	0.4423	0.4139	15.0579	-64.6047	-213.4618	21.8325	-61.6287	-216.9657
5.584	19.6457	-61.0629	-216.5775	0.2058	0.3584	16.4561	-62.2575	-215.8663	22.8352	-59.8683	-217.2886
5.6	19.3411	-61.5416	-216.8208	0.2512	0.3958	16.3255	-62.8015	-215.9821	22.3566	-60.2816	-217.6595
5.616	20.1128	-61.0829	-217.7121	0.0927	0.3712	16.7029	-62.4103	-217.3719	23.5227	-59.7556	-218.0524
5.632	19.3558	-62.5968	-217.2511	0.1449	0.4618	15.9689	-64.2826	-216.6988	22.7427	-60.9111	-217.8033
5.648	19.8115	-61.4631	-218.274	0.0899	0.2228	16.545	-62.2032	-217.9722	23.0781	-60.723	-218.5758
5.664	19.9112	-62.0614	-218.2045	0.0845	0.5715	16.116	-64.5022	-217.8224	23.7065	-59.6206	-218.5866

Rock5

time	pos(x)	pos(y)	pos(z)	el	az	x1	y1	z1	x2	y2	z2
5.68	20.6341	-60.8076	-218.867	-0.0624	0.3542	17.434	-61.991	-219.0801	23.8343	-59.6242	-218.6538
5.696	21.1464	-60.1202	-219.5041	0.0076	0.3789	17.95	-61.3929	-219.4779	24.3427	-58.8475	-219.5304
5.712	20.4888	-61.712	-220.3556	-0.0689	0.5887	16.7833	-64.186	-220.663	24.1943	-59.238	-220.0483
5.728	21.2364	-59.7396	-221.4072	-0.2658	0.4616	17.787	-61.4554	-222.4562	24.6858	-58.0238	-220.3582
5.744	20.9539	-60.8677	-221.2949	-0.2237	0.635	17.1937	-63.6384	-222.3575	24.7142	-58.097	-220.2324
5.76	21.3649	-60.6498	-222.2142	-0.3028	0.4493	17.9736	-62.2849	-223.3903	24.7561	-59.0147	-221.0381
5.776	21.5533	-60.6214	-222.4141	-0.6209	0.2231	18.4132	-61.334	-224.7174	24.6934	-59.9088	-220.1107
5.792	22.2067	-59.3274	-223.2317	-0.3434	0.4041	18.6017	-60.8692	-224.6338	25.8118	-57.7855	-221.8295
5.808	21.5765	-60.9409	-222.3577	-0.576	0.3617	18.6248	-62.0575	-224.4073	24.5282	-59.8243	-220.3081
5.824	22.5285	-59.244	-224.3688	-0.5126	0.4017	18.9311	-60.7724	-226.5683	26.126	-57.7156	-222.1693
5.84	22.1322	-60.1568	-224.0734	-0.5103	0.4084	18.9546	-61.5318	-226.0113	25.3098	-58.7817	-222.1355
5.856	22.8088	-58.7603	-225.0996	-0.4956	0.4932	19.3528	-60.618	-227.2207	26.2649	-56.9025	-222.9786
5.872	22.6416	-59.1196	-224.7211	-0.4923	0.6059	18.9539	-61.6744	-227.1275	26.3292	-56.5647	-222.3148
5.888	22.4431	-59.6014	-224.9563	-0.5766	0.5841	19.3199	-61.6661	-227.3909	25.5664	-57.5367	-222.5217
5.904	23.3666	-57.8635	-225.7688	-0.529	0.5706	20.5458	-59.6738	-227.7279	26.1875	-56.0533	-223.8096
5.92	23.4397	-57.5393	-227.417	-0.6924	0.5972	20.7709	-59.3544	-230.0937	26.1086	-55.7243	-224.7404
5.936	23.6509	-58.063	-227.68	-0.6414	0.6539	21.1498	-59.9797	-230.0332	26.152	-56.1463	-225.3269
5.952	23.888	-57.3308	-228.2362	-0.7509	0.6481	21.5214	-59.1227	-231.0067	26.2546	-55.5389	-225.4658
5.968	24.4692	-56.7588	-229.1951	-0.7579	0.6971	22.0412	-57.7919	-232.1924	26.8973	-53.7257	-226.1979
5.984	24.15	-55.9992	-229.9066	-0.6178	0.8683	21.8548	-58.7104	-232.4305	26.4451	-53.2881	-227.3827
6	24.1711	-56.075	-230.4978	-0.8835	0.8485	22.5638	-57.899	-233.4594	25.7785	-54.2509	-227.5361
6.016	24.1901	-56.8262	-230.3508	-0.4934	0.866	21.8112	-59.6229	-232.3254	26.5689	-54.0296	-228.3762
6.032	24.1522	-56.4413	-231.4641	-0.4684	0.8816	21.7561	-59.349	-233.3704	26.5483	-53.5336	-229.5578
6.048	24.1498	-56.358	-232.2004	-0.4147	1.0367	22.0133	-59.9705	-234.0478	26.2863	-52.7455	-230.3529
6.064	24.018	-57.0498	-232.6456	-0.5129	1.0265	22.2582	-59.9574	-234.5595	25.7778	-54.1422	-230.7318
6.08	24.1841	-56.0933	-233.7954	-0.4739	1.1001	22.5788	-59.2486	-235.611	25.7895	-52.9379	-231.9798
6.096	24.2228	-56.2887	-233.9472	-0.3971	1.0986	22.5149	-59.6326	-235.5221	25.9306	-52.9448	-232.3723
6.112	24.712	-55.7975	-234.5513	-0.3105	1.1028	22.8632	-59.4554	-235.8663	26.5609	-52.1395	-233.2364
6.128	24.8011	-54.9207	-235.6207	-0.179	1.1652	23.1694	-58.72	-236.369	26.4328	-51.1213	-234.8724
6.144	24.5062	-55.238	-236.9579	-0.1158	1.2383	23.2722	-58.812	-237.3977	25.7403	-51.664	-236.5182
6.16	24.3955	-56.0724	-236.72	0.0453	1.1762	22.6366	-60.2962	-236.5127	26.1545	-51.8487	-236.9272
6.176	25.238	-54.7704	-238.3141	0.0252	1.1985	23.973	-58.0099	-238.2263	26.503	-51.5308	-238.4018

Rockan6

time	pos(x)	pos(y)	pos(z)	el	az	x1	y1	z1	x2	y2	z2
0	0	0	0	0.0884	-0.517	-2.9409	1.6722	0.2999	2.9409	-1.6722	-0.2999
0.016	-1.6053	0.3296	-4.4648	0.0549	-0.3548	-5.5201	1.7799	-4.2354	2.3096	-1.1208	-4.6942
0.032	-2.5311	0.3515	-7.082	0.2112	-0.269	-6.6629	1.4905	-6.1632	1.6007	-0.7876	-8.0009
0.048	-5.7056	1.8626	-7.1196	-0.1373	-0.0351	-10.1497	2.0186	-7.734	-1.2615	1.7066	-6.5051
0.064	-6.3505	1.4617	-10.61	-0.0447	0.2825	-9.3618	0.5876	-10.7503	-3.3392	2.3359	-10.4698
0.08	-4.9388	0.6967	-13.9815	-0.0497	0.363	-7.9276	-0.4385	-14.1406	-1.9501	1.832	-13.8225
0.096	-6.5236	-0.0502	-16.2302	0.0524	0.6137	-8.8452	-1.6856	-16.0812	-4.202	1.5852	-16.3791
0.112	-7.8177	-0.5008	-17.9138	0.3981	0.9778	-8.8016	-1.9608	-17.1735	-6.8338	0.9592	-18.6541
0.128	-8.4786	-1.385	-20.593	0.154	1.3617	-9.0367	-4.0142	-20.1758	-7.9206	1.2443	-21.0101
0.144	-9.7615	-1.4655	-21.9953	0.6837	1.7154	-9.4771	-3.4186	-20.3871	-10.046	0.4875	-23.6036
0.16	-9.6693	-2.0804	-23.6812	0.7507	1.5101	-9.8085	-4.3724	-21.5393	-9.5302	0.2116	-25.8232
0.176	-10.264	-1.6166	-23.885	0.9502	1.7781	-9.837	-3.6467	-20.9826	-10.691	0.4135	-26.7874
0.192	-10.7866	-1.661	-25.0769	0.9252	1.8391	-10.1923	-3.8228	-22.1004	-11.381	0.5008	-28.0534
0.208	-11.1837	-1.2775	-26.129	0.6599	1.7827	-10.5799	-4.0838	-23.9016	-11.7875	1.5289	-28.3564
0.224	-11.5699	-1.6577	-26.5076	0.9195	1.8936	-10.8089	-3.9324	-23.3609	-12.3309	0.617	-29.6544
0.24	-11.7037	-1.7589	-28.5036	0.8714	2.0197	-10.5078	-4.2415	-25.2283	-12.8996	0.7236	-31.779
0.256	-12.0191	-1.5706	-29.0725	0.9421	2.0579	-10.9025	-3.6785	-25.7921	-13.1356	0.5373	-32.353
0.272	-12.7282	-2.0601	-31.4715	0.9955	2.246	-11.0308	-4.1797	-27.2839	-14.4256	0.0595	-35.6592
0.288	-12.3831	-2.2011	-33.107	1.0064	2.1568	-11.0542	-4.203	-29.3117	-13.7119	-0.1992	-36.9023
0.304	-12.8947	-1.9876	-34.042	0.952	2.3949	-10.7828	-3.9419	-30.0015	-15.0065	-0.0333	-38.0825
0.32	-13.0703	-1.7392	-35.2316	0.7349	2.416	-10.333	-4.1672	-31.9247	-15.8076	0.6888	-38.5385
0.336	-13.0333	-2.1945	-37.6387	0.8549	2.6065	-9.9756	-4.007	-33.552	-16.091	-0.382	-41.7254
0.352	-12.9476	-1.4286	-38.1937	0.8403	2.4912	-10.2199	-3.5039	-34.3677	-15.6754	0.6467	-42.0197
0.368	-13.7487	-0.9855	-39.4543	0.7442	2.6442	-10.1065	-2.9627	-35.638	-17.3909	0.9918	-43.2706
0.384	-13.6743	-0.506	-40.0334	0.7691	2.695	-10.151	-2.1933	-36.2523	-17.1977	1.1813	-43.8146
0.4	-14.2246	-0.3621	-42.3828	0.7537	2.6533	-10.9679	-2.092	-38.9217	-17.4813	1.3678	-45.8438
0.416	-13.8179	-0.9019	-44.0795	0.7337	2.7898	-9.9357	-2.327	-40.3508	-17.7001	0.5232	-47.8082
0.432	-14.5665	-0.3671	-45.0361	0.6421	2.7185	-10.5863	-2.1594	-41.7718	-18.5467	1.4252	-48.3003
0.448	-14.1467	-0.8459	-47.6585	0.3048	2.649	-9.9426	-3.1023	-46.1572	-18.3507	1.4106	-49.1598
0.464	-14.7161	-0.4719	-49.0335	0.0998	2.6007	-9.9984	-3.3054	-48.4827	-19.4339	2.3616	-49.5844

Rock6

time	pos(x)	pos(y)	pos(z)	el	az	x1	y1	z1	x2	y2	z2
0.48	-14.8912	-0.5961	-50.389	0.036	2.6218	-9.7203	-3.5555	-50.1744	-20.062	2.3634	-50.6036
0.496	-15.4627	-0.1315	-51.5968	0.1275	2.6752	-10.3746	-2.6929	-50.8663	-20.5508	2.4299	-52.3272
0.512	-15.6607	0.3282	-52.557	-0.0542	2.5982	-10.7147	-2.6595	-52.8702	-20.6067	3.3158	-52.2437
0.528	-15.8043	1.1908	-53.6914	-0.0168	2.7015	-10.334	-1.3852	-53.7927	-21.2746	3.7668	-53.5901
0.544	-15.6244	1.1166	-54.2592	-0.2046	2.6985	-9.3849	-1.8443	-55.692	-21.8638	4.0775	-52.8264
0.56	-15.6544	1.2625	-56.3479	-0.2231	2.7342	-9.8522	-1.2411	-57.7817	-21.4565	3.7661	-54.9141
0.576	-15.9827	1.7334	-56.9031	-0.2345	2.8479	-9.7096	-0.1639	-58.4687	-22.2558	3.6307	-55.3375
0.592	-16.0683	2.0093	-57.6657	-0.283	2.8983	-9.0873	0.2768	-59.7576	-23.0492	3.7419	-55.5738
0.608	-15.9024	2.2434	-58.2122	-0.2334	2.9198	-9.0049	0.6881	-59.893	-22.8	3.7987	-56.5314
0.624	-16.2312	3.003	-59.056	-0.2362	2.9294	-9.205	1.4897	-60.7856	-23.2575	4.5164	-57.3264
0.64	-16.7203	4.0762	-60.009	-0.2112	3.0187	-8.8189	3.1	-61.7158	-24.6217	5.0525	-58.3023
0.656	-16.1163	4.2125	-60.3928	-0.2821	2.9378	-7.9643	2.5282	-62.8051	-24.2683	5.8967	-57.9805
0.672	-14.8907	4.2748	-61.362	-0.2751	2.9974	-7.0146	3.1315	-63.608	-22.7667	5.4182	-59.116
0.688	-15.3619	4.998	-61.4504	-0.2416	2.9252	-9.0969	3.6208	-63.0309	-21.6268	6.3752	-59.8699
0.704	-15.2773	5.4537	-61.8913	-0.2175	3.0225	-8.4406	4.6359	-63.4125	-22.1139	6.2714	-60.37
0.72	-16.0367	6.1532	-61.7339	-0.1426	-3.0618	-9.1529	6.7036	-62.7254	-22.9206	5.6029	-60.7424
0.736	-15.0707	6.6947	-61.8897	-0.2116	3.1007	-8.1789	6.4125	-63.3712	-21.9625	6.9769	-60.4081
0.752	-13.7237	7.3401	-62.0065	-0.0846	-3.0702	-6.8923	7.8285	-62.5871	-20.5551	6.8517	-61.4259
0.768	-13.1902	8.5359	-62.4861	-0.0973	-3.0747	-6.1716	7.0065	-63.1724	-20.2089	6.0654	-61.7998
0.784	-13.4681	7.7957	-61.792	-0.1224	-3.0753	-6.0722	8.287	-62.704	-20.864	7.3045	-60.88
0.8	-13.1813	7.5443	-62.2628	-0.1014	-3.1009	-5.3503	7.8629	-63.0603	-21.0123	7.2258	-61.4653
0.816	-12.7751	8.7827	-62.1046	-0.0273	-3.111	-5.4988	9.005	-62.3033	-20.0515	8.5603	-61.9059
0.832	-11.9227	8.4359	-63.283	0.1278	-2.961	-5.0285	9.6946	-62.3827	-18.8169	7.1771	-64.1834
0.848	-11.3053	8.7182	-63.6881	0.0639	-3.0969	-4.2375	9.0343	-63.2358	-18.3731	8.402	-64.1405
0.864	-12.6479	8.4877	-64.51	0.1224	-3.1073	-4.8863	8.7541	-63.5545	-20.4095	8.2213	-65.4655
0.88	-11.098	9.0904	-64.4883	0.3054	-3.0212	-3.8214	9.9704	-62.1774	-18.3746	8.2104	-66.7992
0.896	-10.5162	8.1646	-65.7003	0.2017	-3.0296	-3.1994	8.9875	-64.195	-17.8329	7.3416	-67.2055
0.912	-10.2052	9.2476	-65.2414	0.2264	-3.0094	-2.7383	10.2405	-63.5062	-17.6722	8.2546	-66.9766
0.928	-10.6931	10.7968	-64.6526	0.3428	-3.0148	-2.5361	11.8364	-61.7176	-18.8501	9.7573	-67.5877
0.944	-9.6932	10.4763	-65.269	0.3263	-3.0542	-1.744	11.1727	-62.5685	-17.6424	9.7799	-67.9694
0.96	-9.5067	10.7947	-65.2844	0.3933	-2.9722	-1.8534	12.1036	-62.0627	-17.16	9.4857	-68.506
0.976	-8.7767	11.0997	-66.1052	0.3513	-3.0142	-1.4634	12.0364	-63.4034	-16.0901	10.163	-68.8071
0.992	-9.338	11.0475	-66.1736	0.3861	-3.0279	-1.0772	11.9904	-62.7933	-17.5989	10.1046	-69.5539
1.008	-8.7988	11.6044	-67.1471	0.3872	-3.1018	-0.9905	11.9156	-63.9603	-16.6071	11.2932	-70.3339
1.024	-8.1192	11.2582	-68.7155	0.3794	-3.0035	-0.8382	12.2701	-65.7843	-15.4001	10.2464	-71.6468
1.04	-8.7048	11.275	-68.5561	0.2849	-2.9651	-0.8167	12.682	-66.2093	-16.5929	9.868	-70.903
1.056	-8.2839	11.3143	-69.6621	0.299	-3.0088	-0.482	12.3561	-67.2361	-16.0859	10.2725	-72.0881
1.072	-9.1037	12.0423	-69.46	0.2877	-3.0131	-1.0302	13.0856	-67.0509	-17.1773	10.9991	-71.8692
1.088	-8.9387	11.7219	-70.2266	0.2093	-3.0636	-0.6042	12.3729	-68.4505	-17.2732	11.0709	-72.0027
1.104	-9.3459	10.7344	-71.4307	0.2158	-2.9649	-1.9632	12.053	-69.7868	-16.7286	9.4159	-73.0745
1.12	-8.7376	10.4449	-72.9771	0.2421	-3.019	-1.5336	11.3325	-71.1847	-15.9416	9.5574	-74.7696
1.136	-9.2531	12.0742	-72.4465	-0.2069	2.7481	-1.9373	9.0373	-74.1093	-16.569	15.1111	-70.7837
1.152	-9.2567	11.877	-73.2801	-0.1988	2.7659	-2.3296	9.1448	-74.7805	-16.1838	14.6092	-71.7796
1.168	-9.592	11.4876	-73.9919	-0.1993	2.7116	-2.8877	8.4126	-75.4817	-16.2963	14.5626	-72.5022
1.184	-9.8574	11.6112	-74.2001	-0.2654	2.7056	-4.2226	8.9863	-75.8895	-15.4922	14.2362	-72.5107
1.2	-9.6581	11.1223	-75.0604	-0.2599	2.6307	-4.6391	8.3088	-76.5905	-14.677	13.9359	-73.5302
1.216	-8.8646	10.8456	-76.3716	-0.2851	2.6567	-3.8955	8.2277	-78.0178	-13.8337	13.4635	-74.7254
1.232	-10.2777	10.7634	-76.466	-0.3364	2.6532	-5.5987	8.2774	-78.319	-14.9566	13.2493	-74.6129
1.248	-9.386	11.0117	-77.2957	-0.3321	2.5292	-5.0246	7.948	-79.1336	-13.7474	14.0753	-75.4578
1.264	-10.2443	10.8868	-77.5976	-0.3639	2.5868	-5.9488	8.2245	-79.5226	-14.5398	13.5491	-75.6727
1.28	-8.8357	10.2377	-78.6688	-0.4181	2.4772	-5.0594	7.2805	-80.7997	-12.612	13.1949	-76.5378
1.296	-8.2265	10.5916	-79.0661	-0.4507	2.4338	-5.2079	8.0087	-80.9886	-11.2452	13.1746	-77.1436
1.312	-8.8312	11.1175	-79.9125	-0.2843	2.2949	-5.964	7.8753	-81.1773	-11.6984	14.3597	-78.6476
1.328	-9.0704	11.5642	-80.3983	-0.2134	1.9853	-7.226	7.3721	-81.3905	-10.9149	15.7563	-79.406
1.344	-8.898	11.1127	-81.1035	-0.2152	1.828	-7.8839	7.2573	-81.9749	-9.9121	14.9682	-80.232
1.36	-9.4601	10.6658	-82.19	-0.1539	1.6973	-9.0097	7.1252	-82.7435	-9.9106	14.2063	-81.6365
1.376	-8.6548	10.4404	-82.738	-0.1014	1.635	-8.4029	6.5224	-83.1376	-8.9067	14.3585	-82.3384
1.392	-8.4761	11.0421	-83.1782	-0.1628	1.5791	-8.4397	6.6336	-83.9024	-8.5125	15.4505	-82.4541
1.408	-8.658	10.6389	-84.1652	-0.0555	1.4048	-9.3506	6.5041	-84.3983	-7.9654	14.7737	-83.9322
1.424	-8.1409	9.4153	-84.9618	-0.182	1.3637	-9.3224	3.7929	-86.019	-6.9594	15.0376	-83.9045
1.44	-8.5473	9.3574	-85.4838	-0.1316	1.3082	-9.9522	4.1309	-86.2001	-7.1424	14.5839	-84.7675
1.456	-8.3253	9.0412	-86.599	-0.1646	1.2562	-10.315	2.9276	-87.667	-6.3357	15.1548	-85.531
1.472	-7.5001	9.2778	-86.9873	-0.1962	1.3161	-9.3674	2.1065	-88.4605	-5.6328	16.449	-85.5141
1.488	-8.1032	9.6219	-87.5274	-0.114	1.207	-10.1938	4.1312	-88.1999	-6.0126	15.1125	-86.8549
1.504	-7.9999	7.7464	-88.4644	-0.0327	1.0811	-11.047	2.03	-88.6763	-4.9527	13.4628	-88.2525
1.52	-8.6422	7.8495	-89.4173	-0.024	1.1433	-11.1871	2.264	-89.5648	-6.0973	13.4349	-89.2698

Rock6

time	pos(x)	pos(y)	pos(z)	el	az	x1	y1	z1	x2	y2	z2
1.536	-7.8611	8.8729	-89.5646	0.0655	1.0512	-11.1024	3.2062	-89.1362	-4.6199	14.5396	-89.9929
1.552	-8.1362	6.9687	-91.0525	-0.0397	1.2363	-10.3674	0.5485	-91.3223	-5.9049	13.389	-90.7828
1.568	-8.0723	6.5336	-91.2993	-0.0122	1.1459	-10.9128	0.2559	-91.3835	-5.2319	12.8114	-91.215
1.584	-8.279	7.847	-91.7524	0.1494	0.895	-11.9203	3.3051	-90.8764	-4.6376	12.3888	-92.6284
1.6	-7.9649	7.0943	-92.738	0.114	0.9439	-11.4371	2.3007	-92.0602	-4.4927	11.888	-93.4158
1.616	-7.7283	6.5808	-93.9432	0.1839	0.7125	-12.3421	2.5953	-92.8093	-3.1145	10.5664	-95.0771
1.632	-8.0319	6.9907	-94.1729	0.1264	0.7357	-12.7363	2.7324	-93.3664	-3.3275	11.2491	-94.9794
1.648	-7.6544	5.8497	-94.9853	0.0757	0.7175	-13.1396	1.0633	-94.433	-2.1691	10.6362	-95.5376
1.664	-6.5998	5.8583	-95.7674	0.1478	0.8624	-10.474	1.3363	-94.8809	-2.7256	10.3803	-96.6538
1.68	-7.6078	5.4797	-96.3059	0.0912	0.8232	-11.503	1.2781	-95.7819	-3.7125	9.6812	-96.8299
1.696	-7.6712	6.8521	-96.8811	0.5533	-0.0412	-12.5123	7.0515	-93.8883	-2.83	6.6527	-99.8739
1.712	-8.5194	7.4055	-96.8246	0.4968	0.0086	-14.0627	7.3576	-93.8195	-2.9761	7.4534	-99.8298
1.728	-8.3589	7.4853	-97.9128	0.4067	0.1075	-14.5301	6.8192	-95.2392	-2.1877	8.1513	-100.5863
1.744	-7.7597	6.9116	-98.6171	0.4717	0.0671	-12.4809	6.5945	-96.2036	-3.0386	7.2288	-101.0305
1.76	-8.3851	6.7977	-99.0729	0.3044	0.1451	-13.8226	6.0033	-97.3464	-2.9477	7.5922	-100.7995
1.776	-9.5112	7.8662	-99.0804	0.4228	0.033	-15.1645	7.6796	-96.5355	-3.858	8.0527	-101.6253
1.792	-8.437	6.6886	-100.3019	0.3058	-0.0894	-14.7713	7.2567	-98.2943	-2.1026	6.1205	-102.3095
1.808	-8.905	7.3509	-101.1977	0.3389	0.0111	-15.0832	7.2827	-99.0197	-2.7268	7.4192	-103.3758
1.824	-8.9749	6.5902	-101.8551	0.3436	-0.0758	-15.6748	7.0991	-99.4512	-2.2749	6.0812	-104.2591
1.84	-7.3311	6.1832	-102.7516	0.2937	0.0044	-14.8922	6.1496	-100.4649	0.23	6.2167	-105.0383
1.856	-7.0932	6.1406	-103.4158	0.2462	0.0143	-13.8457	6.044	-101.719	-0.3407	6.2373	-105.1125
1.872	-7.6636	6.5695	-103.7986	0.2431	0.0549	-14.4676	6.1957	-102.1085	-0.8596	6.9433	-105.4887
1.888	-8.7619	6.7413	-104.4034	0.2126	-0.0268	-16.1282	6.9385	-102.8126	-1.3956	6.5441	-105.9941
1.904	-8.3632	7.1555	-105.0913	0.1916	-0.0206	-15.4895	7.3021	-103.7083	-1.2368	7.0088	-106.4742
1.92	-9.1147	6.7256	-106.1589	0.1952	-0.0108	-15.9358	6.7996	-104.8104	-2.2937	6.6516	-107.5074
1.936	-7.6495	6.4951	-107.0074	0.1446	-0.0823	-14.1653	7.0327	-106.055	-1.1336	5.9575	-107.9598
1.952	-8.427	6.1155	-108.3797	-0.0673	-0.0141	-15.1409	6.2104	-108.8325	-1.7131	6.0206	-107.927
1.968	-7.3087	5.4829	-108.992	-0.0689	-0.132	-13.8834	6.3557	-109.4499	-0.734	4.6101	-108.5341
1.984	-6.7951	5.7424	-109.0544	-0.0965	-0.1452	-14.5574	6.8775	-109.8136	0.9671	4.6073	-108.2951
2	-5.7862	5.2827	-109.976	-0.184	-0.1627	-12.7827	6.4315	-111.2952	1.2103	4.134	-108.6567
2.016	-6.4513	6.0499	-109.9263	-0.168	-0.1864	-13.1552	7.3145	-111.0831	0.2525	4.7854	-108.7695
2.032	-6.5152	6.5151	-110.6055	-0.2024	-0.2052	-13.5159	7.972	-112.0731	0.4855	5.0582	-109.1379
2.048	-7.1118	6.9053	-111.4126	-0.263	-0.1525	-13.7851	7.931	-113.2308	-0.4384	5.8796	-109.5945
2.064	-7.4369	7.15	-112.1615	-0.3265	-0.1667	-12.9231	8.0731	-114.0451	-1.9508	6.227	-110.2779
2.08	-7.479	6.6388	-112.9462	-0.2912	-0.2431	-14.1019	8.2813	-114.9915	-0.8561	4.9963	-110.9008
2.096	-6.9885	6.8448	-113.3739	-0.2614	-0.3863	-13.5701	9.522	-115.275	-0.4068	4.1676	-111.4729
2.112	-8.7112	8.0619	-113.6466	-0.3222	-0.4196	-14.3295	10.5679	-115.7003	-3.093	5.5559	-111.5929
2.128	-8.0124	8.0343	-114.4156	-0.2882	-0.3458	-15.242	10.6393	-116.6935	-0.7828	5.4294	-112.1377
2.144	-7.745	8.1282	-115.1361	-0.375	-0.3677	-13.6923	10.4193	-117.645	-1.7977	5.8371	-112.6271
2.16	-6.2579	7.5056	-115.8751	-0.3589	-0.3739	-12.4647	9.9412	-118.3763	-0.0511	5.0701	-113.3739
2.176	-6.779	7.979	-116.296	-0.3546	-0.5007	-12.4973	11.1078	-118.7092	-1.0607	4.8502	-113.8828
2.192	-4.8552	8.6383	-116.8122	-0.4027	-0.6529	-8.977	11.7904	-119.0227	-0.7334	5.4863	-114.6016
2.208	-5.0907	8.7007	-117.386	-0.6312	-0.829	-7.3261	11.14	-119.8046	-2.8552	6.2614	-114.9675
2.224	-4.6427	8.8053	-118.1815	-0.4525	-0.6838	-8.619	12.046	-120.675	-0.6664	5.5645	-115.688
2.24	-4.4172	8.3953	-118.2484	-0.4499	-0.5501	-9.0654	11.2457	-120.8819	0.231	5.5449	-115.6149
2.256	-4.3783	8.7267	-119.0353	-0.5936	-0.6843	-7.4997	11.2732	-121.7538	-1.2569	6.1802	-116.3168
2.272	-4.7861	9.1257	-119.8278	-0.4661	-0.6414	-9.0589	12.3163	-122.5103	-0.5133	5.935	-117.1453
2.288	-4.9113	9.5795	-120.0729	-0.5304	-0.6017	-9.1035	12.4577	-123.0551	-0.7191	6.7012	-117.0907
2.304	-6.7125	9.907	-120.8302	-0.4832	-0.4548	-12.6376	12.8044	-124.2912	-0.7874	7.0095	-117.3691
2.32	-6.6891	10.1674	-122.2877	-0.4392	-0.439	-13.1661	13.2086	-125.6493	-0.212	7.1263	-118.9261
2.336	-6.2671	9.725	-123.112	-0.5872	-0.3983	-12.3417	12.2814	-127.4978	-0.1925	7.1685	-118.7261
2.352	-6.121	10.3461	-123.6852	-0.5069	-0.4435	-12.8043	13.5207	-127.7943	0.5624	7.1714	-119.5761
2.368	-6.6007	11.1155	-124.3502	-0.5763	-0.3703	-12.7758	13.5126	-128.6551	-0.4257	8.7183	-120.0454
2.384	-5.9615	10.7735	-125.0612	-0.6035	-0.3323	-12.2613	12.9473	-129.6548	0.3383	8.5997	-120.4675
2.4	-7.0159	11.051	-125.6314	-0.68	-0.265	-13.0391	12.6857	-130.6783	-0.9928	9.4163	-120.5845
2.416	-7.2462	11.164	-126.7473	-0.629	-0.2505	-14.0566	12.9068	-131.8623	-0.4359	9.4212	-121.6323
2.432	-7.6005	11.3034	-127.4026	-0.652	-0.1337	-14.3484	12.2108	-132.6004	-0.8527	10.396	-122.2047
2.448	-8.4415	11.3801	-128.7788	-0.73	-0.1362	-14.8166	12.2538	-134.5376	-2.0663	10.5063	-123.0201
2.464	-8.1943	12.0928	-129.506	-0.703	-0.0613	-14.8491	12.5014	-135.1561	-1.5395	11.6842	-123.8559
2.48	-9.7787	12.9846	-130.2799	-0.7892	0.0071	-15.7871	12.9421	-136.3349	-3.7702	13.0272	-124.225
2.496	-9.1946	11.8907	-131.7184	-0.7972	0.1966	-14.7871	10.7767	-137.5569	-3.6021	13.0046	-125.88
2.512	-10.1004	13.3688	-131.8102	-0.8607	0.2487	-15.2374	12.0642	-137.9752	-4.9633	14.6734	-125.6452
2.528	-9.975	12.5506	-133.1027	-0.751	0.1667	-15.9374	11.5472	-138.7469	-4.0126	13.554	-127.4584
2.544	-10.5989	12.2355	-133.9234	-0.7679	0.2432	-16.5595	10.7565	-139.8538	-4.6382	13.7145	-127.9931
2.56	-10.3487	12.3458	-135.0387	-0.7107	0.4085	-15.9581	9.9178	-140.2995	-4.7394	14.7739	-129.778
2.576	-9.6591	12.3939	-136.0413	-0.7483	0.4878	-14.7768	9.6788	-141.42	-4.5415	15.109	-130.6626

Rock6

time	pos(x)	pos(y)	pos(z)	el	az	x1	y1	z1	x2	y2	z2
2.592	-10.1768	11.9764	-137.4746	-0.6847	0.5055	-15.7876	8.8711	-142.7102	-4.566	15.0817	-132.239
2.608	-10.0505	11.9485	-138.1134	-0.6219	0.519	-15.9048	8.604	-142.946	-4.1963	15.293	-133.2808
2.624	-10.6936	12.5053	-139.1679	-0.6651	0.5857	-15.4964	9.3196	-143.6879	-5.8907	15.6911	-134.6478
2.64	-10.8656	12.1918	-140.0634	-0.5957	0.4943	-15.9023	9.4777	-143.9415	-5.8289	14.9059	-136.1853
2.656	-10.9223	13.2653	-141.1654	-0.4726	0.3375	-15.9214	11.5109	-143.8743	-5.9232	15.0198	-138.4565
2.672	-11.0606	11.8457	-142.6163	-0.4878	0.5028	-15.6871	9.3015	-145.4174	-6.4341	14.3899	-139.8152
2.688	-11.2702	12.6152	-142.9886	-0.4211	0.546	-14.6209	10.5793	-144.7447	-7.9196	14.6511	-141.2326
2.704	-11.7923	12.5763	-144.2359	-0.3174	0.7347	-14.6827	9.9651	-145.5154	-8.9018	15.1874	-142.9564
2.72	-12.539	12.1442	-144.8957	-0.1351	0.7983	-14.9944	9.6245	-145.3738	-10.0836	14.6639	-144.4176
2.736	-13.639	13.4731	-145.5566	0.0264	1.4409	-14.4876	6.9795	-145.3838	-12.7904	19.9666	-145.7294
2.752	-13.3357	12.7288	-146.6724	0.0849	1.5072	-13.7564	6.1243	-146.1089	-12.9149	19.3333	-147.2359
2.768	-13.5741	12.9242	-147.4585	0.1657	1.4489	-14.3805	6.344	-146.3499	-12.7678	19.5044	-148.567
2.784	-14.2836	12.8708	-148.5472	0.1939	1.5026	-14.6853	6.9885	-147.3895	-13.8819	18.7531	-149.705
2.8	-15.0289	14.0347	-148.73	0.1612	1.6091	-14.7814	7.5728	-147.6782	-15.2764	20.4966	-147.7818
2.816	-14.9423	14.362	-150.0345	0.2171	1.7329	-13.8054	7.4086	-148.4804	-16.0792	21.3155	-151.5887
2.832	-14.003	12.8845	-151.1397	0.1611	1.765	-12.4995	5.2415	-149.8736	-15.5064	20.5274	-152.4058
2.848	-14.7824	13.1442	-151.8872	0.1989	1.7999	-13.4389	7.3834	-150.695	-16.1258	18.9051	-153.0793
2.864	-16.882	14.055	-152.5344	0.1875	1.9027	-14.2638	6.4577	-151.0098	-19.5002	21.6524	-154.0591
2.88	-16.2339	13.4291	-153.1275	0.1923	1.9567	-13.5442	6.8082	-151.7358	-18.9236	20.0501	-154.5193
2.896	-16.7936	14.1584	-154.1115	0.2454	1.9868	-13.8743	7.5496	-152.302	-19.7129	20.7672	-155.921
2.912	-16.5649	13.9071	-154.0352	0.1138	1.9336	-13.5995	6.0945	-153.0803	-19.5303	21.7197	-154.9901
2.928	-17.2925	14.7037	-155.4285	0.1593	1.976	-13.6226	6.1478	-153.9328	-20.9625	23.2596	-156.9242
2.944	-17.1548	14.7269	-155.6641	0.1389	2.1127	-12.7021	7.3312	-154.457	-21.6075	22.1226	-156.8713
2.96	-18.2294	14.3046	-156.2336	0.0754	2.1472	-13.4059	6.8842	-155.5654	-23.0529	21.725	-156.9019
2.976	-17.2571	12.0781	-156.7279	0.035	2.1951	-12.3666	5.2897	-156.4348	-22.1477	18.8665	-157.0209
2.992	-17.9968	13.2051	-157.4301	-0.0153	2.2983	-12.6847	7.2389	-157.552	-23.309	19.1713	-157.3082
3.008	-16.9297	12.5719	-157.2961	-0.0967	2.3472	-11.1486	6.6856	-158.0962	-22.7108	18.4583	-156.496
3.024	-17.6009	12.8198	-158.1151	-0.2164	2.4418	-9.9653	6.3905	-160.3097	-25.2365	19.249	-155.9206
3.04	-17.9191	12.4205	-158.6314	-0.2707	2.4773	-10.1679	6.3517	-161.3631	-25.6703	18.4893	-155.8996
3.056	-18.225	12.1818	-160.139	-0.2454	2.4986	-9.9271	5.9648	-162.7359	-26.5229	18.3987	-157.5421
3.072	-19.0465	11.9922	-159.7787	-0.3324	2.5939	-10.195	6.5931	-163.3577	-27.8979	17.3912	-156.1997
3.088	-17.4798	11.7875	-160.2371	-0.4084	2.4766	-10.7506	6.5108	-163.938	-24.209	17.0641	-156.5362
3.104	-18.3434	12.7354	-160.4835	-0.4432	2.5425	-11.5621	8.1049	-164.3817	-25.1246	17.3658	-156.5853
3.12	-19.3561	12.5022	-161.0902	-0.4954	2.6561	-12.4823	8.8758	-165.2897	-26.2299	16.1285	-156.8907
3.136	-19.2442	12.5149	-161.4371	-0.5563	2.7251	-12.1962	9.3975	-166.2293	-26.2922	15.6323	-156.645
3.152	-17.788	12.4719	-162.5607	-0.5819	2.77	-11.5316	10.0341	-166.9776	-24.0444	14.9096	-158.1437
3.168	-17.9468	12.4353	-163.4468	-0.5918	2.8946	-11.0597	10.699	-168.2212	-24.8339	14.1716	-158.6723
3.184	-17.3489	12.4723	-163.93	-0.595	2.9576	-10.556	11.208	-168.6063	-24.1418	13.7365	-159.2537
3.2	-18.3808	13.179	-164.821	-0.5725	3.0517	-10.9576	12.5096	-169.6244	-25.804	13.8484	-160.0176
3.216	-16.9378	13.3251	-165.583	-0.6305	-3.1163	-10.5005	13.4881	-170.2832	-23.3751	13.1621	-160.8829
3.232	-17.9646	13.2522	-166.2469	-0.6352	-2.9446	-11.4805	14.5461	-171.1201	-24.4488	11.9582	-161.3736
3.248	-17.9063	13.8689	-166.968	-0.68	-2.9289	-11.7978	15.188	-172.0216	-24.0147	12.5498	-161.9144
3.264	-17.0575	13.1524	-167.8737	-0.6811	-2.789	-11.6222	15.1526	-172.5676	-22.4928	11.1522	-163.1798
3.28	-17.8414	14.1636	-168.2642	-0.6446	-2.689	-12.3064	16.8548	-172.8904	-23.3764	11.4724	-163.6381
3.296	-19.0302	15.3724	-169.2099	-0.6028	-2.7222	-12.9403	18.0875	-173.7994	-25.12	12.6572	-164.6203
3.312	-19.2527	14.959	-169.8245	-0.5921	-2.7197	-13.2933	17.6338	-174.2181	-25.2121	12.2842	-165.4308
3.328	-18.4724	14.8309	-170.8089	-0.5656	-2.5804	-12.9784	18.2845	-174.9281	-23.9665	11.3772	-166.6897
3.344	-19.105	15.3568	-171.5645	-0.555	-2.71	-12.567	18.368	-176.0278	-25.643	12.3455	-167.1012
3.36	-17.5677	14.9048	-172.4871	-0.5523	-2.3982	-12.1612	19.8757	-177.0136	-22.9743	9.934	-167.9606
3.376	-17.8667	15.8544	-173.3718	-0.5579	-2.5516	-12.3319	19.5602	-177.5278	-23.4014	12.1486	-169.2157
3.392	-16.8113	15.0615	-174.4401	-0.5299	-2.4437	-11.2747	19.7048	-178.6727	-22.3479	10.4182	-170.2076
3.408	-16.4959	15.0764	-175.2154	-0.4803	-2.5138	-10.3791	19.5157	-179.1526	-22.6127	10.6371	-171.2783
3.424	-16.5255	15.6964	-175.9305	-0.5033	-2.4713	-10.713	20.3038	-180.0139	-22.338	11.0891	-171.847
3.44	-16.9345	16.0722	-177.3259	-0.4289	-2.499	-10.9674	20.5388	-180.7347	-22.9016	11.6057	-173.9172
3.456	-17.0529	15.9233	-177.8422	-0.3602	-2.5171	-10.3411	20.7602	-180.9586	-23.7648	11.0863	-174.7258
3.472	-16.7661	16.3127	-178.6056	-0.3549	-2.5368	-10.3398	20.7543	-181.5006	-23.1924	11.8711	-175.7106
3.488	-16.2992	16.5763	-179.9189	-0.3147	-2.487	-10.1933	21.2622	-182.4242	-22.4051	11.8905	-177.4136
3.504	-16.247	16.9968	-181.0079	-0.2978	-2.5724	-9.1259	21.5528	-183.6022	-23.3681	12.4408	-178.4135
3.52	-17.0863	17.7059	-182.4193	-0.2555	-2.5977	-10.2766	21.8237	-184.4977	-23.896	13.5882	-180.3409
3.536	-16.1661	17.848	-183.0342	-0.1567	-2.6329	-9.1574	21.7559	-184.3023	-23.1748	13.94	-181.7662
3.552	-15.412	17.7994	-183.4282	-0.1326	-2.49	-9.4531	22.3447	-184.4275	-21.3709	13.254	-182.4288
3.568	-15.8481	18.3244	-184.7144	-0.0518	-2.5977	-7.9763	23.085	-185.1915	-23.7199	13.5637	-184.2372
3.584	-15.1475	17.6284	-185.6868	0.0052	-2.571	-8.2895	22.03	-185.6448	-22.0056	13.2268	-185.7289
3.6	-13.8553	17.0556	-186.7237	0.0757	-2.4994	-7.3968	21.8862	-186.1122	-20.3138	12.2251	-187.3353
3.616	-14.1942	18.2267	-188.2898	0.1614	-2.6414	-6.5579	22.4	-186.873	-21.8305	14.0534	-189.7066
3.632	-14.2415	17.5486	-188.5269	0.207	-2.8103	-7.3937	19.9038	-187.006	-21.0892	15.1934	-190.0477

Rock6

time	pos(x)	pos(y)	pos(z)	el	az	x1	y1	z1	x2	y2	z2
3.648	-14.2495	18.0653	-188.9182	0.2404	-2.8706	-7.1875	20.0277	-187.1213	-21.3116	16.1029	-190.7152
3.664	-13.873	18.7333	-190.3264	0.2442	-2.8768	-7.6573	20.4189	-188.7214	-20.0886	17.0477	-191.9313
3.68	-14.3044	19.7667	-191.0696	0.2726	-2.9989	-7.4783	20.7475	-189.1415	-21.1305	18.786	-192.9976
3.696	-14.6606	18.7892	-192.4535	0.3011	-2.8596	-9.1886	20.3743	-190.6844	-20.1327	17.2041	-194.2227
3.712	-14.5725	20.1819	-193.1007	0.2592	-2.8181	-9.7852	21.787	-191.7617	-19.3597	18.5769	-194.4397
3.728	-13.2359	18.9216	-194.0472	0.2598	-2.7547	-7.9387	21.0797	-192.5268	-18.533	16.7635	-195.5675
3.744	-13.2652	19.6025	-195.0921	0.2789	-2.9163	-7.0433	21.0284	-193.2643	-19.487	18.1766	-196.9198
3.76	-11.6272	19.4647	-195.4112	0.2931	-3.0247	-4.3457	20.3199	-193.1989	-18.9088	18.6095	-197.6235
3.776	-10.5942	19.5212	-195.5704	0.382	-2.8476	-3.5818	21.6442	-192.6274	-17.6067	17.3982	-198.5135
3.792	-11.7903	20.4163	-196.7284	0.4266	-2.9599	-5.5765	21.5582	-193.8569	-18.0041	19.2743	-199.6
3.808	-10.7641	19.5356	-197.342	0.4614	-2.9693	-3.529	20.7946	-193.6909	-17.9992	18.2766	-200.9931
3.824	-9.845	20.2106	-198.4599	0.4336	-2.9648	-2.2528	21.5672	-194.8895	-17.4373	18.854	-202.0304
3.84	-10.6805	19.6938	-199.1884	0.4625	-3.0107	-3.5163	20.6371	-195.5853	-17.8448	18.7504	-202.7914
3.856	-9.4169	19.1183	-199.1772	0.4844	-3.0121	-2.3768	20.0353	-195.4408	-16.4571	18.2013	-202.9136
3.872	-10.5451	20.0738	-200.2533	0.4371	-2.8452	-3.6199	22.1889	-196.8702	-17.4704	17.9587	-203.6365
3.888	-8.9385	19.6909	-200.4776	0.4086	-3.0126	-1.7573	20.6226	-197.342	-16.1196	18.7593	-203.6131
3.904	-8.8386	18.919	-201.6844	0.3866	-2.979	-1.7265	20.0858	-198.7507	-15.9506	17.7522	-204.6182
3.92	-9.5742	18.9996	-202.6138	0.4152	-2.8727	-2.8713	20.8468	-199.5487	-16.2771	17.1525	-205.6788
3.936	-8.4411	18.8628	-202.6949	0.3675	-2.9423	-1.0639	20.0926	-199.7972	-15.8182	17.113	-205.5925
3.952	-10.3806	19.3993	-204.4919	0.3719	-3.0018	-1.9276	20.5885	-201.1628	-18.8336	18.2102	-207.821
3.968	-10.2687	19.037	-204.6097	0.4252	-3.0441	-2.9714	19.7507	-201.2894	-17.566	18.3234	-207.93
3.984	-10.227	19.5999	-205.6477	0.3308	-2.8503	-2.9035	21.7956	-203.0222	-17.5505	17.4043	-208.2732
4	-10.2388	18.8659	-206.0916	0.3621	-2.8199	-3.5019	21.1108	-203.4021	-16.9757	16.6211	-208.7811
4.016	-9.9839	18.0524	-206.9968	0.2912	-2.6381	-3.9738	21.3629	-204.9402	-15.994	14.7419	-209.0534
4.032	-9.16	17.8505	-207.9851	0.2356	-2.7201	-3.0572	20.5868	-206.3794	-15.2629	15.1143	-209.5908
4.048	-9.7394	18.5164	-208.4376	0.2094	-2.7791	-3.0444	21.0555	-206.9162	-16.4345	15.9773	-209.9589
4.064	-9.6596	17.7867	-208.7391	0.2374	-2.833	-2.3395	20.1205	-206.8801	-16.9797	15.4528	-210.598
4.08	-9.8102	17.546	-209.266	0.0685	-2.491	-3.5882	22.2819	-208.7298	-16.0323	12.81	-209.8021
4.096	-9.8299	19.0725	-210.2474	-0.0205	-2.413	-3.3221	24.88	-210.426	-16.3377	13.2651	-210.0687
4.112	-10.6673	18.6386	-210.9858	-0.0958	-2.4282	-3.5541	24.7948	-211.8899	-17.7805	12.4825	-210.0817
4.128	-10.0919	18.8602	-212.0386	-0.1356	-2.3876	-3.7479	24.8177	-213.2264	-16.4358	12.9027	-210.8509
4.144	-9.4075	17.8567	-212.6161	-0.1744	-2.4476	-2.5372	23.573	-214.1909	-16.2778	12.1404	-211.0413
4.16	-10.2303	18.1258	-212.9726	-0.2551	-2.5094	-3.0005	23.4209	-215.3098	-17.46	12.8307	-210.6354
4.176	-9.5873	17.317	-213.3578	-0.3282	-2.4507	-3.1264	22.6586	-216.2122	-16.0482	11.9753	-210.5034
4.192	-11.8215	18.0112	-214.7068	-0.4632	-2.4467	-5.7424	23.0788	-218.6594	-17.9006	12.9435	-210.7542
4.208	-12.8349	18.8307	-215.1325	-0.4688	-2.3255	-7.5351	24.4666	-219.0511	-18.1348	13.1948	-211.214
4.224	-11.4261	17.1671	-215.5888	-0.4818	-2.2153	-7.1263	22.8883	-219.3309	-15.7258	11.4459	-211.8467
4.24	-12.1964	17.6742	-215.7708	-0.5259	-2.1469	-8.3547	23.5886	-219.8641	-16.038	11.7599	-211.6776
4.256	-9.5712	16.9078	-217.1651	-0.5484	-2.4013	-4.2865	21.7357	-221.5377	-14.8558	12.0799	-212.7925
4.272	-10.9753	17.9683	-217.6557	-0.5486	-2.4984	-4.4249	22.8784	-222.6591	-17.5257	13.0582	-212.6523
4.288	-11.0252	17.7226	-218.3097	-0.6419	-2.3917	-6.3268	22.0988	-223.1098	-15.7237	13.3464	-213.5096
4.304	-13.0198	18.2798	-219.0147	-0.7646	-2.0066	-10.5706	23.5401	-224.5812	-15.469	13.0195	-213.4482
4.32	-11.6248	18.0565	-220.0671	-0.8075	-1.839	-10.2594	23.0252	-225.4533	-12.9903	13.0877	-214.6809
4.336	-10.9764	17.8064	-220.945	-0.7971	-1.7979	-9.7659	23.0456	-226.4499	-12.1868	12.5672	-215.44
4.352	-11.4608	18.0073	-221.4364	-0.8472	-1.9859	-9.3151	22.8763	-227.4588	-13.6065	13.1383	-215.414
4.368	-9.8942	17.7733	-222.3908	-0.8336	-1.9648	-7.8732	22.6339	-228.188	-11.9152	12.9127	-216.5937
4.384	-11.1788	18.1265	-223.5114	-0.8379	-1.7538	-10.2344	23.2286	-229.2762	-12.1232	13.0243	-217.7465
4.4	-10.141	17.7006	-224.3419	-0.8082	-1.629	-9.7952	23.6395	-230.5687	-10.4869	11.7617	-218.1151
4.416	-10.2836	17.5669	-224.5191	-0.7637	-1.4261	-11.1625	23.5971	-230.3537	-9.4046	11.5367	-218.6845
4.432	-10.2647	18.2435	-226.1305	-0.7421	-1.3352	-11.6742	24.1156	-231.6684	-8.8552	12.3713	-220.5926
4.448	-9.6103	17.0209	-226.6733	-0.737	-1.2806	-11.5587	23.5453	-232.8529	-7.662	10.4966	-220.4936
4.464	-9.5153	18.0877	-227.6582	-0.72	-1.2538	-11.332	23.6256	-232.7697	-7.6985	12.5498	-222.5466
4.48	-9.5968	17.6466	-228.2785	-0.6808	-1.2832	-11.3461	23.56	-233.2734	-7.8474	11.7331	-223.2837
4.496	-9.9959	17.9689	-229.2334	-0.6795	-1.1729	-12.3841	23.6518	-234.2133	-7.6076	12.2861	-224.2535
4.512	-10.474	19.316	-230.7084	-0.6417	-1.1031	-13.2148	24.7424	-235.2509	-7.7333	13.8895	-226.1659
4.528	-10.0758	18.9565	-231.8402	-0.4996	-1.0136	-14.2572	25.6684	-236.1557	-5.8943	12.2447	-227.5248
4.544	-10.8752	20.6091	-233.6953	-0.5449	-1.1051	-14.2283	27.2804	-238.2205	-7.5221	13.9378	-229.17
4.56	-10.8387	20.5148	-234.4104	-0.4902	-1.0294	-15.3019	27.937	-239.0323	-6.3754	13.0926	-229.7885
4.576	-11.5525	20.7772	-235.4825	-0.4555	-1.0914	-14.8627	27.1452	-238.9978	-8.2424	14.4093	-231.9672
4.592	-11.0541	20.1293	-236.3652	-0.4009	-1.0889	-14.5709	26.8537	-239.5817	-7.5374	13.4049	-233.1487
4.608	-12.0893	21.4926	-237.6393	-0.3493	-1.1188	-15.5156	28.5491	-240.4968	-8.663	14.4361	-234.7818
4.624	-12.2403	21.337	-238.6118	-0.3254	-1.1862	-14.9069	27.9247	-241.0093	-9.5737	14.7494	-236.2144
4.64	-11.586	19.6789	-239.1948	-0.3108	-1.1407	-14.9482	27.0076	-241.7846	-8.2237	12.3502	-236.605
4.656	-12.1901	21.5673	-240.841	-0.3211	-1.2585	-14.5004	28.7241	-243.3424	-9.8799	14.4105	-238.3396
4.672	-11.627	20.6304	-241.1037	-0.2457	-1.2363	-14.0449	27.587	-242.9502	-9.209	13.6738	-239.2571
4.688	-12.077	21.7015	-241.787	-0.2203	-1.204	-14.6526	28.4064	-243.3957	-9.5014	14.9966	-240.1783

Rock6											
time	pos(x)	pos(y)	pos(z)	el	az	x1	y1	z1	x2	y2	z2
4.704	-14.0928	21.573	-242.0509	-0.0637	-1.1483	-17.4412	29.0209	-242.5721	-10.7444	14.125	-241.5297
4.72	-12.644	21.4547	-243.5902	-0.0537	-1.2141	-15.4239	28.9151	-244.0184	-9.8641	13.9942	-243.1619
4.736	-11.9056	20.5794	-244.9927	0.0329	-1.2536	-14.1478	27.4086	-244.7558	-9.6634	13.7502	-245.2296
4.752	-11.1543	21.2556	-245.2892	0.0089	-1.152	-14.2873	28.2949	-245.2203	-8.0213	14.2164	-245.358
4.768	-10.4622	19.5179	-245.5147	0.3109	-1.0708	-12.7677	23.7381	-243.9693	-8.1568	15.2977	-247.06
4.784	-8.5914	18.9395	-246.6806	0.5409	-0.9884	-10.6226	22.0236	-244.4623	-6.5602	15.8554	-248.8989
4.8	-8.0897	17.9844	-246.7876	0.2238	-0.907	-11.6804	22.5747	-245.4609	-4.4989	13.3941	-248.1144
4.816	-7.3577	19.9303	-248.0381	0.466	-0.8795	-9.9463	23.0587	-245.996	-4.7691	16.8018	-250.0802
4.832	-6.5721	18.4304	-248.9726	0.6039	-0.7784	-10.1159	21.9248	-245.5392	-3.0283	14.936	-252.4059
4.848	-7.3729	19.8257	-250.4694	0.4079	-0.7652	-11.3701	23.6644	-248.0748	-3.3758	15.9869	-252.8641
4.864	-7.1577	20.2295	-250.7252	0.1921	-0.8473	-11.6392	25.3031	-249.4088	-2.6763	15.1559	-252.0415
4.88	-7.7061	21.4811	-252.1787	0.3274	-0.7371	-11.8446	25.2377	-250.2803	-3.5675	17.7244	-254.077
4.896	-7.0486	20.3761	-252.4254	-0.0081	-0.7705	-12.0836	25.2635	-252.4822	-2.0136	15.4887	-252.3687
4.912	-6.4287	21.8853	-253.8346	-0.1045	-0.9237	-12.1625	29.4736	-254.8324	-0.6948	14.297	-252.8367
4.928	-4.9102	22.4034	-253.7911	0.01	-0.7278	-11.2889	28.087	-253.7053	1.4685	16.7197	-253.8769
4.944	-4.9749	21.1743	-253.9196	-0.1084	-0.7748	-10.813	26.89	-254.8084	0.8632	15.4585	-253.0307
4.96	-4.2615	22.1469	-256.0663	-0.1262	-0.7069	-11.4589	28.2951	-257.2672	2.9359	15.9987	-254.8654
4.976	-3.5678	21.5571	-256.0174	-0.1761	-0.764	-8.9555	26.7187	-257.3452	1.8199	16.3954	-254.6897
4.992	-3.5967	21.1788	-256.7563	-0.2543	-0.7097	-9.9871	26.6681	-258.9458	2.7937	15.6896	-254.5669
5.008	-3.0692	21.2763	-257.3002	-0.3062	-0.6125	-9.3737	25.7057	-259.7365	3.2353	16.8469	-254.864
5.024	-2.746	22.3288	-258.1139	-0.313	-0.6744	-8.7165	27.1017	-260.5879	3.2245	17.556	-255.64
5.04	-1.9912	21.2226	-258.5016	-0.3647	-0.7646	-7.5611	26.5659	-261.4481	3.5786	15.8794	-255.5552
5.056	-2.0692	21.3511	-258.5443	-0.3427	-0.6105	-8.0706	25.5505	-261.1573	3.9321	17.1518	-255.9314
5.072	-2.1713	20.4493	-259.0042	-0.4616	-0.6003	-8.406	24.7178	-262.7624	4.0634	16.1808	-255.246
5.088	-2.7448	20.6691	-260.0426	-0.4664	-0.5509	-9.9557	25.0989	-264.3029	4.4661	16.2393	-255.7824
5.104	-2.7818	20.8998	-261.6609	-0.5659	-0.3575	-10.7344	23.8706	-267.0533	5.1709	17.9291	-256.2685
5.12	-2.5103	20.1385	-262.0121	-0.5951	-0.305	-9.3417	22.2895	-266.8609	4.3211	17.9875	-257.1632
5.136	-2.7015	20.2215	-262.7447	-0.7365	-0.1981	-9.3947	21.5651	-268.9339	3.9918	18.8779	-256.5555
5.152	-2.1655	19.8969	-262.9428	-0.7411	-0.1794	-8.1243	20.9773	-268.4849	3.7933	18.8165	-257.4008
5.168	-2.611	19.9283	-263.7291	-0.7653	-0.161	-9.2187	21.0013	-270.1594	3.9967	18.8554	-257.2988

Rockan7											
time	pos(x)	pos(y)	pos(z)	el	az	x1	y1	z1	x2	y2	z2
0	0	0	0	-1.036	0.0976	-2.8689	-0.2808	-4.8661	2.8689	0.2808	4.8661
0.016	0.0844	0.2036	-3.5267	-0.687	-0.0959	-4.8684	0.68	-7.6081	5.0372	-0.2728	0.5547
0.032	-1.6716	-0.6527	-8.3117	-0.4006	-0.1131	-6.1973	-0.1386	-10.2404	2.8541	-1.1668	-6.383
0.048	-2.9835	0.4923	-9.6637	-0.1575	-0.0144	-8.4359	0.5707	-10.5296	2.4689	0.4139	-8.7979
0.064	-4.0747	-0.2591	-14.011	0.2413	-0.0301	-10.2228	-0.0737	-12.4976	2.0734	-0.4444	-15.5245
0.08	-5.1334	-0.2308	-15.6122	0.1889	0.3039	-9.9618	-1.7452	-14.6447	-0.3051	1.2836	-16.5797
0.096	-5.4782	-1.7529	-19.5987	0.5395	0.3877	-8.7996	-3.1091	-17.4506	-2.1569	-0.3967	-21.7468
0.112	-6.2388	-1.8332	-20.9123	0.9226	0.562	-8.1274	-3.0226	-17.9654	-4.3503	-0.6438	-23.8592
0.128	-6.2086	-2.5174	-22.988	1.2778	0.8078	-6.9785	-3.3226	-19.2952	-5.4388	-1.7122	-26.6807
0.144	-6.9774	-1.9273	-23.8906	1.3868	1.3649	-7.1478	-2.7431	-19.4117	-6.807	-1.1115	-28.3695
0.16	-7.9504	-1.2419	-24.9113	1.4102	1.3532	-8.1178	-1.9993	-20.1218	-7.7829	-0.4846	-29.7008
0.176	-8.0686	-1.4086	-26.855	1.4178	0.8474	-8.5631	-1.9686	-22.0108	-7.5741	-0.8486	-31.6993
0.192	-8.0752	-1.3944	-28.7151	1.3287	2.1477	-7.4686	-2.3267	-24.2112	-8.6818	-0.4622	-33.2191
0.208	-8.2004	-1.7825	-30.5	1.3594	2.4017	-7.4342	-2.482	-25.6651	-8.9667	-1.083	-35.3349
0.224	-8.2492	-1.6948	-32.3026	1.3587	2.7458	-7.1884	-2.1381	-26.9647	-9.3101	-1.2515	-37.6405
0.24	-8.1131	-2.0703	-34.4601	1.5283	2.2237	-7.965	-2.2638	-28.7298	-8.2611	-1.8767	-40.1903
0.256	-8.9011	-1.5447	-35.9486	1.4701	3.1277	-8.2882	-1.5532	-29.8846	-9.5139	-1.5362	-42.0125
0.272	-8.6329	-2.0101	-38.637	1.4575	-1.8472	-8.4424	-1.3385	-32.5	-8.8235	-2.6817	-44.774
0.288	-9.346	-2.6209	-40.4849	1.4318	-2.3988	-8.7479	-2.0717	-34.6801	-9.944	-3.17	-46.2897
0.304	-10.2476	-2.5785	-42.6254	1.418	-2.9646	-9.3514	-2.4183	-36.7147	-11.1438	-2.7388	-48.5362
0.32	-10.9965	-2.8584	-44.7547	1.3874	-2.5269	-10.028	-2.1748	-38.3639	-11.9651	-3.5421	-51.1456
0.336	-10.996	-3.3171	-47.3547	1.4268	-2.6194	-10.2217	-2.8716	-41.1955	-11.7703	-3.7627	-53.514
0.352	-11.6293	-3.4014	-49.5731	1.337	-2.4767	-10.4217	-2.4547	-43.1287	-12.837	-4.3482	-56.0174
0.368	-11.9298	-2.7456	-51.1134	1.3111	-2.8062	-10.3007	-2.1778	-44.6207	-13.5588	-3.3134	-57.6061
0.384	-12.3614	-3.7768	-53.3246	1.2356	-2.5396	-10.3355	-2.3848	-46.2678	-14.3873	-5.1688	-60.3813
0.4	-12.4976	-3.1699	-55.2443	1.2982	-2.4076	-11.1667	-1.9693	-48.8335	-13.8286	-4.3705	-61.6551
0.416	-13.4086	-3.9235	-58.0711	1.1975	-2.6113	-11.0681	-2.5513	-51.1435	-15.749	-5.2957	-64.9987
0.432	-13.971	-4.081	-59.773	1.1908	-2.6993	-11.6419	-2.978	-53.32	-16.3002	-5.184	-66.226
0.448	-14.2866	-4.6549	-62.4639	1.2348	-2.5039	-12.3344	-3.2084	-55.5065	-16.2387	-6.1013	-69.4213
0.464	-14.0599	-4.5705	-64.4057	1.2665	-2.5541	-12.3297	-3.4182	-57.7872	-15.7901	-5.7228	-71.0242
0.48	-13.8444	-5.5873	-66.3981	1.0812	-2.7027	-10.8745	-4.193	-60.2417	-16.8143	-6.9816	-72.5545
0.496	-14.4511	-5.7911	-68.7213	1.0971	-2.6355	-11.5566	-4.1867	-62.2653	-17.3456	-7.3954	-75.1773

Rock7

time	pos(x)	pos(y)	pos(z)	el	az	x1	y1	z1	x2	y2	z2
0.512	-16.3717	-5.8505	-70.8695	1.0719	-2.4537	-13.6482	-3.6123	-64.3999	-19.0953	-8.0888	-77.339
0.528	-16.6594	-6.3358	-72.9414	1.1565	-2.2872	-14.8521	-4.26	-66.6833	-18.4667	-8.4116	-79.1994
0.544	-17.0787	-6.9618	-74.2907	1.154	-2.282	-15.2102	-4.7935	-67.8258	-18.9471	-9.1302	-80.7556
0.56	-17.4008	-7.1568	-76.8738	1.0827	-2.3047	-15.0951	-4.6005	-70.3901	-19.7064	-9.713	-83.3576
0.576	-18.5963	-7.6408	-79.0776	1.0003	-2.3349	-15.8034	-4.7265	-72.7872	-21.3892	-10.5552	-85.368
0.592	-18.3817	-8.2186	-80.6898	0.9507	-2.4722	-14.8829	-5.4504	-74.4423	-21.8804	-10.9868	-86.9373
0.608	-19.9841	-8.0069	-83.1022	0.9023	-2.228	-17.2896	-4.515	-77.5177	-22.6785	-11.4988	-88.6866
0.624	-21.1172	-8.7436	-85.0702	0.8131	-2.1954	-18.3338	-4.8826	-80.0391	-23.9006	-12.6045	-90.1013
0.64	-21.3	-9.2206	-86.4297	0.7864	-2.2768	-18.3029	-5.7054	-81.8007	-24.297	-12.7357	-91.0588
0.656	-21.6486	-10.0353	-88.2429	0.7587	-2.2936	-18.4497	-6.4085	-83.6587	-24.8474	-13.6621	-92.8271
0.672	-22.6299	-10.1995	-89.399	0.6769	-2.2763	-19.4412	-6.456	-85.448	-25.8185	-13.9429	-93.35
0.688	-24.2396	-10.7746	-91.0894	0.654	-1.7532	-23.4073	-6.2632	-87.5732	-25.0719	-15.286	-94.6055
0.704	-25.071	-10.9635	-92.1876	0.5645	-2.0336	-22.7575	-6.3264	-88.9057	-27.3846	-15.6006	-95.4694
0.72	-24.015	-12.0236	-93.4817	0.4948	-2.277	-20.8837	-7.7664	-90.4629	-27.6462	-16.2807	-96.5005
0.736	-23.2926	-13.324	-94.7776	0.406	-2.4599	-18.5569	-9.4812	-92.1559	-28.0284	-17.1669	-97.3993
0.752	-24.2026	-13.3893	-95.7488	0.405	-2.429	-19.836	-9.616	-93.2746	-28.5692	-17.1625	-98.2229
0.768	-23.5052	-14.7183	-96.3555	0.3914	-2.375	-19.4689	-10.8314	-94.0427	-27.5414	-18.6051	-98.6683
0.784	-24.2887	-14.3886	-98.0971	0.3967	-2.3773	-20.3481	-10.6111	-95.8102	-28.2294	-18.1661	-100.384
0.8	-26.2875	-15.51	-99.0706	0.4175	-2.086	-23.8885	-11.2729	-96.9108	-28.6864	-19.7472	-101.2305
0.816	-26.5059	-15.9092	-99.5864	0.3169	-2.2416	-23.6214	-12.2745	-98.0647	-29.3904	-19.544	-101.108
0.832	-28.9572	-15.8551	-99.9651	0.6418	-1.8095	-27.978	-11.8312	-96.8699	-29.9364	-19.8789	-103.0602
0.848	-28.3252	-16.593	-100.7624	0.6547	-1.9607	-26.9064	-13.1408	-97.8973	-29.7441	-20.0452	-103.6274
0.864	-29.4463	-16.5229	-100.9039	0.4724	-2.0503	-27.5438	-12.8639	-98.7964	-31.3487	-20.1819	-103.0115
0.88	-28.4462	-17.6961	-101.7123	0.6295	-1.8272	-27.5898	-14.4299	-99.2529	-29.3026	-20.9624	-104.1716
0.896	-29.5527	-17.844	-101.6501	0.5236	-1.8184	-28.4929	-13.6509	-99.1529	-30.6126	-22.0372	-104.1473
0.912	-28.2454	-18.8861	-103.4407	0.5721	-1.5871	-28.1729	-14.4437	-100.5795	-28.3179	-23.3286	-106.302
0.928	-29.1875	-19.3055	-103.4742	0.5405	-1.6184	-28.9924	-15.2077	-101.0122	-29.3827	-23.4033	-105.9363
0.944	-29.4094	-19.5195	-104.3471	0.6241	-1.5348	-29.5575	-15.4065	-101.3833	-29.2612	-23.6325	-107.3108
0.96	-29.4106	-20.8257	-105.134	0.5173	-1.5055	-29.7051	-16.3212	-102.5658	-29.1161	-25.3302	-107.7022
0.976	-28.7414	-21.7498	-106.112	0.508	-1.5229	-28.9685	-17.0131	-103.4715	-28.5142	-26.4866	-108.7524
0.992	-28.6929	-21.8725	-106.393	0.5148	-1.3431	-29.6525	-17.7316	-103.9884	-27.7333	-26.0135	-108.7976
1.008	-28.8287	-22.2922	-107.0398	0.4801	-1.2953	-29.8441	-18.7	-105.096	-27.8134	-25.8843	-108.9835
1.024	-30.5189	-22.4661	-107.4937	0.2297	-0.9995	-33.233	-18.244	-106.32	-27.8047	-26.6882	-108.6674
1.04	-30.0571	-22.9652	-108.1356	0.2294	-1.098	-32.3669	-18.4494	-106.9513	-27.7472	-27.481	-109.3198
1.056	-29.5985	-23.5927	-108.5648	0.0647	-1.093	-31.8396	-19.2643	-108.2491	-27.3575	-27.9212	-108.8805
1.072	-29.6228	-24.1062	-109.4273	0.0574	-1.1132	-31.8033	-19.6782	-109.1437	-27.4424	-28.5343	-109.711
1.088	-29.2987	-24.5101	-109.2544	0.06	-1.1026	-31.5263	-20.1053	-108.9581	-27.071	-28.9149	-109.5507
1.104	-28.9145	-25.0816	-110.2818	-0.0168	-1.0814	-31.1008	-20.9769	-110.3598	-26.7281	-29.1863	-110.2038
1.12	-28.3598	-25.6969	-110.7302	0.0105	-1.128	-30.4041	-21.386	-110.6803	-26.3155	-30.0078	-110.7801
1.136	-28.0034	-26.005	-111.034	-0.0749	-1.1181	-30.3091	-21.2645	-111.4295	-25.6976	-30.7456	-110.6385
1.152	-27.2467	-26.7144	-111.8169	-0.1251	-1.1464	-29.0932	-22.6276	-112.3807	-25.4002	-30.8012	-111.253
1.168	-26.2907	-27.2988	-112.2029	-0.1286	-1.1396	-28.2084	-23.1305	-112.796	-24.373	-31.4671	-111.6098
1.184	-26.7066	-27.3489	-112.4837	-0.1394	-1.1992	-28.3236	-23.1996	-113.1087	-25.0895	-31.4981	-111.8586
1.2	-26.5992	-26.7278	-111.9509	-0.1138	-1.2015	-28.3507	-22.203	-112.5056	-24.8477	-31.2525	-111.3962
1.216	-26.2801	-27.3162	-112.6961	-0.1602	-1.2219	-28.0278	-22.5114	-113.5223	-24.5324	-32.1209	-111.8699
1.232	-26.0261	-27.8908	-113.3416	-0.2234	-1.3303	-27.0876	-23.562	-114.3539	-24.9646	-32.2195	-112.3292
1.248	-25.3937	-27.8334	-113.6138	-0.3404	-1.3581	-26.2263	-23.9773	-115.0112	-24.5611	-31.6896	-112.2165
1.264	-24.7399	-28.776	-114.4261	-0.3097	-1.4085	-25.4106	-24.6796	-115.7545	-24.0692	-32.8723	-113.0977
1.28	-24.3072	-29.4452	-114.9689	-0.5588	-1.4875	-24.5791	-26.1902	-117.0115	-24.0354	-32.7001	-112.9264
1.296	-24.7086	-29.3983	-115.258	-0.503	-1.3317	-25.5166	-26.0836	-117.1353	-23.9006	-32.7129	-113.3808
1.312	-24.2759	-29.9783	-115.7439	-0.4876	-1.3539	-25.0273	-26.5682	-117.5956	-23.5245	-33.3884	-113.8923
1.328	-24.0067	-30.235	-116.2635	-0.4084	-1.418	-24.6079	-26.3311	-117.9728	-23.4055	-34.1388	-114.5542
1.344	-23.7333	-30.1329	-116.6171	-0.4493	-1.4413	-24.1921	-26.6102	-118.3301	-23.2746	-33.6557	-114.9042
1.36	-23.6721	-30.2064	-117.0642	-0.4044	-1.3895	-24.4102	-26.1801	-118.8162	-22.9341	-34.2327	-115.3121
1.376	-23.6234	-30.4366	-117.5469	-0.4522	-1.4634	-24.0074	-26.8741	-119.2875	-23.2393	-33.9991	-115.8064
1.392	-23.678	-30.3217	-117.6736	-0.5796	-1.4695	-24.0369	-26.7916	-119.9965	-23.319	-33.8518	-115.3507
1.408	-23.3155	-31.1572	-118.8783	-0.3761	-1.3893	-24.0693	-27.0492	-120.5276	-22.5618	-35.2651	-117.2289
1.424	-23.5803	-31.0945	-119.0332	-0.4123	-1.3938	-24.277	-27.1999	-120.7635	-22.8835	-34.9892	-117.3029
1.44	-23.3874	-31.1972	-119.6012	-0.4029	-1.3883	-24.0944	-27.3668	-121.2614	-22.6803	-35.0275	-117.9409
1.456	-23.3893	-31.3776	-120.2438	-0.4982	-1.4469	-23.8197	-27.9208	-122.1385	-22.9589	-34.8343	-118.3491
1.472	-23.0381	-31.7909	-121.3003	-0.4368	-1.4091	-23.6822	-27.8434	-123.1675	-22.3941	-35.7384	-119.433
1.488	-23.3996	-31.9136	-121.6325	-0.3801	-1.3797	-24.1759	-27.8996	-123.2659	-22.6233	-35.9275	-119.9992
1.504	-23.5471	-32.0037	-122.1464	-0.4849	-1.3533	-24.3517	-28.362	-124.1112	-22.7425	-35.6454	-120.1816
1.52	-23.3064	-32.4504	-123.1347	-0.2953	-1.2638	-24.7062	-28.035	-124.544	-21.9065	-36.8658	-121.7255
1.536	-22.9768	-32.5907	-123.7036	-0.2845	-1.3663	-23.9722	-27.7917	-125.1367	-21.9815	-37.3897	-122.2705
1.552	-23.1814	-32.4825	-124.0771	-0.2533	-1.3429	-24.1764	-28.1923	-125.217	-22.1864	-36.7728	-122.9371

Rock7

time	pos(x)	pos(y)	pos(z)	el	az	x1	y1	z1	x2	y2	z2
1.568	-22.8616	-33.1312	-124.9401	-0.3912	-1.3274	-23.839	-29.1958	-126.6124	-21.8842	-37.0667	-123.2678
1.584	-22.629	-33.2675	-125.5844	-0.2749	-1.2963	-23.8732	-28.8493	-126.8789	-21.3847	-37.6857	-124.2899
1.6	-22.5653	-33.5949	-126.4576	-0.1754	-1.3253	-23.7294	-28.9491	-127.3065	-21.4012	-38.2407	-125.6087
1.616	-22.5122	-33.831	-127.2272	-0.1557	-1.2532	-23.9982	-29.3102	-127.9745	-21.0262	-38.3518	-126.48
1.632	-22.2949	-34.0224	-127.8864	-0.1045	-1.2755	-23.6508	-29.5642	-128.3754	-20.9389	-38.4807	-127.3974
1.648	-22.6249	-33.8082	-128.3671	-0.1531	-1.2841	-23.9913	-29.174	-129.1125	-21.2585	-38.4424	-127.6216
1.664	-22.3682	-34.4867	-129.0961	-0.1148	-1.2368	-23.9593	-29.9021	-129.6556	-20.7771	-39.0713	-128.5366
1.68	-22.1073	-35.7172	-130.3286	-0.2132	-1.2581	-23.3185	-31.9714	-131.1808	-20.8961	-39.4631	-129.4764
1.696	-23.0392	-34.5331	-130.855	-0.111	-1.2584	-24.2315	-30.8423	-131.2875	-21.847	-38.224	-130.4225
1.712	-22.6871	-34.619	-131.3215	-0.083	-1.2091	-24.283	-30.4005	-131.6968	-21.0913	-38.8374	-130.9462
1.728	-22.5928	-35.2501	-131.96	0.0432	-1.1638	-24.3061	-31.2755	-131.7731	-20.8796	-39.2246	-132.1469
1.744	-22.9868	-34.7617	-132.5928	0.1845	-1.1584	-25.7723	-28.3944	-131.2959	-20.2012	-41.1289	-133.8898
1.76	-22.683	-35.4954	-133.5919	0.2247	-1.1776	-25.2617	-29.2786	-132.0536	-20.1044	-41.7123	-135.1301
1.776	-22.9886	-35.8076	-134.3732	0.1758	-1.1724	-25.5033	-29.8323	-133.2213	-20.4738	-41.7828	-135.5251
1.792	-22.7495	-36.5678	-135.0651	0.2351	-1.1653	-25.5708	-29.9958	-133.3519	-19.9282	-43.1397	-136.7783
1.808	-22.489	-36.5201	-135.5606	0.2454	-1.1406	-25.4752	-30.0131	-133.7675	-19.5029	-43.0272	-137.3537
1.824	-23.1242	-36.7685	-136.3771	0.2406	-1.1355	-26.1844	-30.1883	-134.5964	-20.0641	-43.3488	-138.1579
1.84	-22.8079	-36.3786	-136.6044	0.2428	-1.1624	-25.8945	-29.2453	-134.6792	-19.7213	-43.512	-138.5296
1.856	-22.8309	-36.6907	-137.5727	0.2298	-1.1391	-25.9604	-29.897	-135.8232	-19.7014	-43.4844	-139.3223
1.872	-22.7597	-37.1	-138.2587	0.1837	-1.158	-25.7608	-30.2473	-136.869	-19.7585	-43.9527	-139.6484
1.888	-22.6494	-37.2832	-138.4101	0.1719	-1.2135	-25.0267	-30.9147	-137.2299	-20.2722	-43.6516	-139.5903
1.904	-22.3019	-37.2615	-139.4244	0.1732	-1.2108	-25.0148	-30.0537	-138.0767	-19.5891	-44.4693	-140.772
1.92	-22.1784	-37.9631	-139.9158	0.1309	-1.2348	-24.6131	-30.9923	-138.944	-19.7437	-44.934	-140.8877
1.936	-21.6698	-38.4791	-140.8979	0.1764	-1.2173	-24.1467	-31.7658	-139.6225	-19.1929	-45.1923	-142.1734
1.952	-21.9012	-38.9111	-141.227	0.2196	-1.1938	-24.5918	-32.1155	-139.5955	-19.2105	-45.7067	-142.8585
1.968	-22.1079	-39.4536	-141.9285	0.2237	-1.1653	-25.0657	-32.5639	-140.2231	-19.1501	-46.3433	-143.634
1.984	-22.3938	-38.9595	-142.4732	0.2051	-1.225	-25.0419	-31.608	-140.8476	-19.7456	-46.311	-144.0987
2	-22.1853	-39.6398	-143.4031	0.2124	-1.2009	-24.8897	-32.6647	-141.7895	-19.4809	-46.615	-145.0167
2.016	-22.2095	-39.8409	-143.6017	0.1735	-1.2323	-24.6338	-32.9543	-142.3222	-19.7852	-46.7274	-144.8813
2.032	-22.0173	-40.4345	-144.3823	0.2117	-1.233	-24.6871	-32.8341	-142.6511	-19.3475	-48.0348	-146.1135
2.048	-21.0722	-41.5148	-145.348	0.1988	-1.2504	-23.5588	-34.0205	-143.7574	-18.5856	-49.0091	-146.9386
2.064	-21.3771	-41.4055	-145.4952	0.1498	-1.2703	-23.4399	-34.7487	-144.4431	-19.3142	-48.0623	-146.5472
2.08	-21.3151	-41.5592	-146.1319	0.1455	-1.2774	-23.4542	-34.4789	-145.0481	-19.1761	-48.6396	-147.2156
2.096	-20.6222	-41.899	-146.7574	0.0896	-1.3504	-22.2446	-34.657	-146.0906	-18.9998	-49.1411	-147.4242
2.112	-19.9804	-42.3327	-147.2985	0.0567	-1.5308	-20.2404	-35.838	-146.9298	-19.7204	-48.8274	-147.6672
2.128	-19.6409	-42.781	-148.6452	0.0426	-1.5647	-19.6786	-36.598	-148.3815	-19.6032	-48.964	-148.9088
2.144	-19.3315	-43.5907	-149.0286	0.0145	-1.5201	-19.6453	-37.4002	-148.9386	-19.0177	-49.7811	-149.1186
2.16	-19.8974	-43.3428	-149.299	-0.0463	-1.5836	-19.8186	-37.201	-149.5838	-19.9762	-49.4847	-149.0142
2.176	-18.8466	-44.2332	-150.247	-0.1112	-1.5797	-18.7943	-38.3404	-150.9053	-18.8988	-50.1261	-149.5888
2.192	-19.3296	-44.3327	-150.7989	-0.1106	-1.5114	-19.6815	-38.417	-151.4567	-18.9778	-50.2484	-150.1411
2.208	-19.6196	-44.287	-151.0655	-0.1932	-1.665	-19.1542	-39.3597	-152.0339	-20.0849	-49.2143	-150.0971
2.224	-18.3874	-45.4033	-152.1043	-0.1004	-1.4876	-18.8529	-39.8185	-152.6686	-17.9219	-50.9881	-151.54
2.24	-18.9614	-46.3228	-152.6987	-0.2989	-1.6098	-18.7792	-41.6481	-154.1404	-19.1436	-50.9976	-151.257
2.256	-19.5844	-45.7051	-153.0147	-0.2391	-1.4447	-20.2007	-40.8415	-154.2095	-18.968	-50.5686	-151.8199
2.272	-19.5064	-45.4105	-153.3172	-0.3822	-1.4644	-19.9626	-41.1379	-155.0444	-19.0502	-49.6832	-151.59
2.288	-19.4872	-46.0718	-153.759	-0.4579	-1.623	-19.2836	-42.1783	-155.6807	-19.6908	-49.9652	-151.8374
2.304	-18.6095	-47.0733	-154.5603	-0.3424	-1.7079	-18.0979	-43.3645	-155.895	-19.1211	-50.7821	-153.2256
2.32	-19.3971	-47.0026	-154.8116	-0.5133	-1.6685	-19.1006	-43.9768	-156.5256	-19.6936	-50.0284	-153.0976
2.336	-19.2056	-46.6264	-154.7536	-0.3077	-1.6317	-18.9548	-42.5155	-156.0622	-19.4563	-50.7372	-153.4449
2.352	-19.4009	-46.1552	-156.3892	-0.4804	-1.8364	-18.5632	-43.0756	-158.0525	-20.2386	-49.2348	-154.7259
2.368	-19.0514	-47.15	-156.7115	-0.3793	-1.9227	-17.8057	-43.7572	-158.1521	-20.297	-50.5429	-155.2708
2.384	-19.2048	-46.6073	-157.0129	-0.5477	-2.3107	-17.4036	-44.6343	-158.6426	-21.0059	-48.5804	-155.3833
2.4	-17.6494	-48.3114	-157.4373	-0.4664	-2.3194	-15.4206	-45.9122	-159.086	-19.8783	-50.7107	-155.7885
2.416	-18.365	-47.5415	-158.0889	-0.5762	-2.3476	-16.115	-45.2524	-160.1743	-20.615	-49.8306	-156.0035
2.432	-18.15	-47.8384	-158.5498	-0.5807	-2.2486	-16.3305	-45.5782	-160.4535	-19.9694	-50.0986	-156.6461
2.448	-18.0714	-47.9198	-159.4334	-0.5783	-2.7593	-15.2714	-46.794	-161.4033	-20.8715	-49.0457	-157.4636
2.464	-17.7988	-48.1891	-160.0133	-0.4824	-2.7066	-15.1939	-46.9786	-161.5175	-20.4037	-49.3996	-158.5091
2.48	-17.1602	-48.7204	-160.8638	-0.5412	-2.8184	-14.1852	-47.724	-162.7497	-20.1351	-49.7168	-158.978
2.496	-16.907	-49.0975	-161.3751	-0.442	-2.9286	-13.583	-48.3786	-162.9844	-20.2309	-49.8164	-159.7658
2.512	-16.6478	-49.6424	-161.8935	-0.3889	-2.8609	-13.3644	-48.6959	-163.2939	-19.9312	-50.5888	-160.4931
2.528	-16.9804	-49.2946	-162.5135	-0.2909	-3.0384	-13.2776	-48.911	-163.6279	-20.6831	-49.6782	-161.3992
2.544	-17.1073	-48.8219	-162.921	-0.2309	3.0675	-13.1132	-49.1183	-163.8626	-21.1014	-48.5256	-161.9794
2.56	-17.1576	-48.7864	-164.0151	-0.0763	3.0455	-13.1676	-49.1708	-164.3216	-21.1477	-48.402	-163.7086
2.576	-16.2072	-50.3127	-164.2864	-0.1313	2.8669	-12.0072	-51.4964	-164.8626	-20.4071	-49.1289	-163.7102
2.592	-15.9893	-50.9107	-165.273	-0.3604	2.759	-11.674	-52.6475	-167.0259	-20.3047	-49.174	-163.52
2.608	-15.3903	-51.1706	-165.6156	-0.3578	2.9303	-11.5492	-51.9944	-167.0844	-19.2314	-50.3468	-164.1469

Rock7

time	pos(x)	pos(y)	pos(z)	el	az	x1	y1	z1	x2	y2	z2
2.624	-15.2578	-51.1827	-166.0291	-0.4088	3.0458	-11.8064	-51.5145	-167.5313	-18.7093	-50.8509	-164.5269
2.64	-14.9318	-52.2122	-166.7032	-0.4171	2.9958	-11.4814	-52.7188	-168.2486	-18.3823	-51.7057	-165.1578
2.656	-15.0806	-51.1095	-167.2979	-0.4136	-2.9578	-11.9351	-50.5248	-168.7023	-18.2261	-51.6943	-165.8936
2.672	-14.9898	-51.4956	-167.4876	-0.4896	3.127	-11.6159	-51.5447	-169.2856	-18.3637	-51.4464	-165.6897
2.688	-14.6451	-51.5836	-168.6467	-0.4228	-3.0707	-11.3735	-51.3514	-170.1225	-17.9167	-51.8159	-167.1708
2.704	-14.7729	-51.2354	-169.2546	-0.4593	-3.1062	-11.4536	-51.1179	-170.8972	-18.0922	-51.3529	-167.612
2.72	-14.823	-51.3845	-169.2745	-0.3468	-2.8334	-11.8039	-50.4235	-170.4194	-17.8422	-52.3455	-168.1295
2.736	-14.9226	-51.0169	-170.2421	-0.4678	-2.7135	-12.1271	-49.7414	-171.7945	-17.7181	-52.2924	-168.6897
2.752	-14.8374	-50.7694	-170.3703	-0.4325	-2.8559	-11.9078	-49.9088	-171.7799	-17.767	-51.63	-168.9608
2.768	-14.5297	-51.7686	-171.013	-0.4537	-2.7273	-11.681	-50.5159	-172.5304	-17.3784	-53.0213	-169.4957
2.784	-14.4189	-51.6023	-171.5545	-0.4881	-2.4557	-12.1992	-49.7855	-173.0776	-16.6386	-53.4192	-170.0315
2.8	-14.7622	-51.441	-172.0271	-0.4335	3.0947	-11.4185	-51.5981	-173.5765	-18.1059	-51.284	-170.4778
2.816	-15.2668	-50.846	-172.3696	-0.5027	-2.7316	-12.7755	-49.7632	-173.863	-17.758	-51.9287	-170.8763
2.832	-15.344	-50.4843	-173.1902	-0.6229	-2.7636	-13.1601	-49.6171	-174.878	-17.5279	-51.3515	-171.5023
2.848	-15.102	-50.8156	-174.151	-0.4972	3.1404	-11.9204	-50.8194	-175.8776	-18.2837	-50.8118	-172.4243
2.864	-14.4405	-51.7056	-175.1537	-0.3166	2.9576	-10.3538	-52.4663	-176.5156	-18.5273	-50.945	-173.7917
2.88	-14.4903	-51.4688	-175.7313	-0.2121	3.122	-11.3277	-51.5308	-176.4125	-17.6529	-51.4068	-175.0501
2.896	-14.2717	-51.2563	-175.9169	-0.1975	-2.051	-12.4387	-47.7376	-176.711	-16.1047	-54.7751	-175.1229
2.912	-13.8955	-51.7451	-176.0647	-0.1614	-1.8218	-12.8365	-47.6144	-176.7591	-14.9544	-55.8757	-175.3703
2.928	-13.9285	-52.9238	-177.3957	0.2097	-1.3875	-15.1944	-46.0961	-175.9175	-12.6626	-59.7515	-178.874
2.944	-14.4882	-53.2173	-177.8256	0.1992	-1.4548	-15.2305	-46.8494	-176.5312	-13.746	-59.5853	-179.1199
2.96	-14.1366	-52.2372	-178.4745	0.1495	-1.3755	-15.4831	-45.4294	-177.4294	-12.7902	-59.0451	-179.5196
2.976	-13.942	-52.5945	-177.9738	0.1022	-1.357	-15.5089	-45.3761	-177.2163	-12.375	-59.813	-178.7313
2.992	-14.2721	-52.5578	-178.5022	0.1718	-1.3497	-15.903	-45.3032	-177.212	-12.6412	-59.8125	-179.7923
3.008	-13.5824	-52.7123	-178.8456	0.1832	-1.4446	-14.3905	-46.3446	-177.6561	-12.7743	-59.0799	-180.0351
3.024	-13.7974	-54.1123	-180.287	0.1444	-1.3814	-15.1367	-47.1254	-179.2523	-12.458	-61.0992	-181.3216
3.04	-13.6172	-55.1582	-180.6043	0.1086	-1.4959	-14.0951	-48.7885	-179.9079	-13.1393	-61.5278	-181.3008
3.056	-13.9997	-55.6142	-181.1025	0.246	-1.3258	-15.6369	-49.0649	-179.4077	-12.3625	-62.1635	-182.7974
3.072	-13.8777	-55.3203	-181.0917	0.1548	-1.2698	-16.1851	-47.8875	-179.8776	-11.5703	-62.7531	-182.3058
3.088	-14.3927	-55.7106	-181.8127	0.163	-1.2014	-16.9001	-49.2348	-180.6704	-11.8852	-62.1865	-182.9549
3.104	-14.0892	-56.1534	-182.1833	0.086	-1.2208	-16.7244	-48.9343	-181.5208	-11.4539	-63.3725	-182.8457
3.12	-14.1912	-55.498	-182.5788	0.0606	-1.2565	-16.1693	-49.4126	-182.1905	-12.2132	-61.5835	-182.9671
3.136	-14.1877	-56.3767	-183.3344	0.0886	-1.3038	-15.5543	-51.3802	-182.8745	-12.821	-61.3732	-183.7944
3.152	-14.5203	-55.5971	-183.3281	0.0118	-1.3228	-15.9737	-49.8568	-183.2584	-13.0669	-61.3375	-183.3979
3.168	-13.9627	-56.784	-183.9909	0.0639	-1.3615	-15.2545	-50.7029	-183.593	-12.6709	-62.8652	-184.3888
3.184	-14.8285	-56.2517	-184.3075	0.0666	-1.3727	-15.9694	-50.5684	-183.9209	-13.6876	-61.9351	-184.694
3.2	-13.9054	-56.63	-184.7346	-0.0106	-1.3961	-14.9499	-50.7112	-184.7986	-12.861	-62.5488	-184.6707
3.216	-13.9375	-57.0647	-185.2725	-0.0581	-1.4522	-14.6011	-51.495	-185.599	-13.274	-62.6345	-184.946
3.232	-14.3402	-56.9733	-186.0048	-0.0824	-1.4203	-15.1337	-51.7397	-186.4418	-13.5467	-62.207	-185.5677
3.248	-14.2285	-56.9713	-186.4882	-0.1024	-1.2982	-15.9954	-50.6501	-187.1625	-12.4616	-63.2925	-185.8139
3.264	-14.0108	-57.5456	-187.1522	-0.102	-1.3653	-15.2676	-51.5152	-187.7829	-12.754	-63.5759	-186.5215
3.28	-14.529	-56.7113	-187.7549	-0.1737	-1.4255	-15.431	-50.5475	-188.8478	-13.627	-62.875	-186.662
3.296	-14.5164	-56.9851	-187.8055	-0.2131	-1.4617	-15.1564	-51.1393	-189.078	-13.8763	-62.8309	-186.5329
3.312	-14.4949	-56.9734	-188.5925	-0.3196	-1.5087	-14.8559	-51.1623	-190.5193	-14.1338	-62.7846	-186.6656
3.328	-14.6394	-57.0021	-189.0593	-0.3515	-1.3729	-15.789	-51.2689	-191.2035	-13.4897	-62.7353	-186.9151
3.344	-14.6563	-57.3819	-189.5578	-0.4157	-1.4804	-15.1429	-52.011	-191.9387	-14.1697	-62.7528	-187.177
3.36	-15.3568	-57.0443	-190.2363	-0.3998	-1.4227	-16.1124	-51.9806	-192.3996	-14.6012	-62.1081	-188.073
3.376	-14.9636	-57.7045	-190.6552	-0.5046	-1.4733	-15.4481	-52.7501	-193.4045	-14.479	-62.659	-187.906
3.392	-14.783	-57.6688	-191.4057	-0.5928	-1.5412	-14.9127	-53.2865	-194.3593	-14.6533	-62.0512	-188.452
3.408	-14.5521	-58.3323	-191.5118	-0.6386	-1.4737	-14.9967	-53.7669	-194.9168	-14.1075	-62.8976	-188.1068
3.424	-15.7526	-57.6532	-191.898	-0.77	-1.8742	-14.718	-54.3481	-195.2565	-16.7873	-60.9583	-188.5396
3.44	-15.1988	-57.9826	-192.7927	-0.8202	-1.9437	-13.9586	-54.8129	-196.4416	-16.4389	-61.1523	-189.1438
3.456	-14.9311	-57.9	-193.1783	-0.8159	-1.6205	-14.7578	-54.4154	-196.8872	-15.1044	-61.3845	-189.4695
3.472	-15.1872	-57.7911	-193.7008	-0.8459	-1.656	-14.9234	-54.7009	-197.2025	-15.451	-60.8814	-190.199
3.488	-14.5357	-58.0814	-194.2709	-0.8799	-1.7258	-14.0945	-55.2585	-197.7267	-14.9768	-60.9043	-190.8151
3.504	-15.1907	-57.7655	-194.6152	-1.0501	-1.9808	-14.3741	-55.887	-198.1874	-16.0072	-59.6441	-191.043
3.52	-14.331	-58.4181	-194.8253	-1.1005	-2.3721	-12.9687	-57.0984	-198.5569	-15.6934	-59.7378	-191.0937
3.536	-15.4472	-57.7655	-195.3688	-0.9148	-3.014	-12.8134	-57.4275	-198.8189	-18.081	-58.1035	-191.9187
3.552	-15.2372	-58.2353	-195.9865	-0.9344	-3.1144	-12.8819	-58.1712	-199.1751	-17.5925	-58.2995	-192.7979
3.568	-14.8238	-58.6022	-196.2727	-1.0071	3.1343	-12.5678	-58.6186	-199.8415	-17.0799	-58.5858	-192.7038
3.584	-15.3407	-58.0973	-197.0844	-0.8574	3.0901	-12.7608	-58.2303	-200.0694	-17.9205	-57.9644	-194.0993
3.6	-15.1932	-58.1817	-197.4557	-0.7356	2.9518	-12.1279	-58.7705	-200.2808	-18.2585	-57.5928	-194.6306
3.616	-15.0587	-57.9857	-198.1074	-0.5151	2.7488	-11.1852	-59.5904	-200.4806	-18.9322	-56.381	-195.7341
3.632	-15.3998	-57.7877	-198.708	-0.4279	2.7165	-11.227	-59.6766	-200.7973	-19.5727	-55.8989	-196.6187
3.648	-15.5576	-58.1284	-199.2386	-0.3912	2.7308	-11.4479	-59.9183	-201.0876	-19.6672	-56.3386	-197.3896
3.664	-15.3313	-58.4158	-199.9043	-0.3021	2.7215	-11.2509	-60.2383	-201.297	-19.4117	-56.5932	-198.5116

Rock7

time	pos(x)	pos(y)	pos(z)	el	az	x1	y1	z1	x2	y2	z2
3.68	-15.2904	-58.0146	-200.357	-0.248	2.6858	-10.777	-60.2272	-201.6298	-19.8038	-55.8021	-199.0842
3.696	-15.1259	-58.0779	-200.7351	-0.2173	2.6506	-11.2502	-60.1503	-201.7055	-19.0017	-56.0056	-199.7647
3.712	-14.4559	-58.9203	-201.2892	-0.1367	2.6458	-10.1726	-61.2368	-201.959	-18.7392	-56.6037	-200.6194
3.728	-15.3087	-58.7823	-201.7867	-0.0292	2.6183	-10.9317	-61.3075	-201.9343	-19.6857	-56.2572	-201.6391
3.744	-14.579	-58.6658	-202.5451	0.0092	2.6266	-10.669	-60.8785	-202.5039	-18.4891	-56.4532	-202.5863
3.76	-14.574	-58.4873	-203.1504	0.0851	2.5956	-10.6977	-60.8423	-202.7635	-18.4503	-56.1322	-203.5373
3.776	-15.2831	-58.0638	-203.823	0.171	2.5642	-10.9279	-60.9011	-202.9254	-19.6383	-55.2265	-204.7206
3.792	-15.026	-59.2194	-205.0549	0.4185	2.3652	-9.7097	-64.4409	-201.7406	-20.3422	-53.9978	-208.3693
3.808	-14.3687	-58.6457	-205.6636	0.4461	2.2572	-10.4743	-63.3985	-202.7251	-18.2631	-53.8929	-208.6021
3.824	-15.9212	-56.9243	-206.4392	0.4851	2.2273	-12.3089	-61.6124	-203.3196	-19.5334	-52.2361	-209.5587
3.84	-16.3544	-56.2186	-207.5368	0.4641	2.2921	-11.6521	-61.566	-203.9726	-21.0567	-50.8712	-211.101
3.856	-15.7836	-57.2617	-207.6229	0.4294	2.247	-11.2902	-62.8619	-204.3353	-20.277	-51.6614	-210.9105
3.872	-15.9583	-57.7414	-207.8297	0.436	2.2898	-11.6412	-62.6737	-204.7758	-20.2755	-52.809	-210.8836
3.888	-17.7213	-54.3699	-210.0134	0.4593	2.2889	-13.4434	-59.2658	-206.798	-21.9993	-49.474	-212.2289
3.904	-16.5598	-56.0878	-210.1274	0.4933	2.2617	-12.064	-61.5252	-206.3341	-21.0557	-50.6504	-213.9207
3.92	-17.4485	-54.4874	-211.2305	0.4622	2.2032	-12.4781	-61.2696	-207.0417	-22.4189	-47.7053	-215.4193
3.936	-18.1544	-53.9227	-211.3336	0.4063	2.2206	-14.0117	-59.3748	-208.3875	-22.2971	-48.4706	-214.2797
3.952	-17.9849	-54.1628	-212.2241	0.5396	2.2753	-13.3363	-59.632	-207.9258	-22.6335	-48.6936	-216.5224
3.968	-17.0834	-55.4547	-211.6675	0.5037	2.3081	-11.7172	-61.364	-207.2683	-22.4496	-49.5453	-212.0666
3.984	-19.0377	-50.953	-214.2755	0.4466	2.3317	-14.0819	-56.1572	-210.8344	-23.9935	-45.7488	-217.7167
4	-18.9731	-52.1877	-213.9668	0.5699	2.1711	-15.2444	-57.6342	-209.7367	-22.7018	-46.7412	-218.1969
4.016	-19.9396	-50.7333	-215.3195	0.5448	2.2366	-15.1409	-56.8423	-210.6117	-24.7383	-44.6244	-220.0274
4.032	-18.7025	-52.2111	-214.8873	0.6144	2.1891	-15.5675	-56.6182	-211.0715	-21.8375	-47.8039	-218.7032
4.048	-18.8756	-51.7484	-216.7421	0.6566	2.1646	-15.9464	-56.087	-212.708	-21.8047	-47.4098	-220.7761
4.064	-19.9794	-49.9773	-217.7421	0.5453	2.0806	-18.1173	-53.3076	-215.4275	-21.8415	-46.647	-220.0567
4.08	-20.1141	-50.4285	-218.2034	0.5515	2.0879	-17.7172	-54.643	-215.2207	-22.511	-46.214	-221.186
4.096	-20.6218	-49.5445	-218.858	0.5521	2.0879	-18.2241	-53.7605	-215.8703	-23.0195	-45.3285	-221.8458
4.112	-21.1852	-48.8622	-219.4933	0.4547	2.1089	-18.3646	-53.5875	-216.8028	-24.0057	-44.137	-222.1839
4.128	-21.6951	-47.0031	-220.2116	0.3988	2.1329	-18.8759	-51.4792	-217.9827	-24.5144	-42.527	-222.4404
4.144	-21.6546	-48.3459	-220.8779	0.3289	2.1899	-17.7473	-53.8297	-218.5802	-25.5619	-42.862	-223.1757
4.16	-23.7458	-46.3638	-222.0962	0.2617	2.2126	-19.2148	-52.4261	-220.0692	-28.2769	-40.3015	-224.1231
4.176	-24.7048	-45.4218	-223.0573	0.2529	2.2071	-19.716	-52.1745	-220.888	-29.6935	-38.6691	-225.2267
4.192	-25.0261	-45.0897	-223.2814	0.2138	2.2102	-20.9572	-50.5612	-221.8009	-29.095	-39.6181	-224.7619
4.208	-24.5795	-45.1414	-223.4417	0.1682	2.1977	-20.5691	-50.6777	-222.2808	-28.5899	-39.6051	-224.6027
4.224	-24.9258	-44.7432	-224.3084	0.1029	2.1783	-20.4218	-51.2225	-223.4937	-29.4298	-38.2639	-225.1231
4.24	-24.8829	-44.6899	-225.1908	0.1425	2.0956	-21.3232	-50.8387	-224.1715	-28.4426	-38.541	-226.2101
4.256	-26.6532	-42.8118	-226.0253	0.068	2.2284	-22.3494	-48.3846	-225.5454	-30.957	-37.2391	-226.5052
4.272	-27.1949	-42.6822	-226.5433	0.0461	2.2208	-22.5207	-48.8305	-226.1869	-31.8692	-36.5339	-226.8997
4.288	-26.7329	-42.9708	-226.5308	0.0785	2.1555	-22.8269	-48.8715	-225.9745	-30.6389	-37.0701	-227.0871
4.304	-28.3433	-41.3864	-227.8473	0.0018	2.1819	-24.0568	-47.5047	-227.8336	-32.6297	-35.2682	-227.8611
4.32	-28.2372	-41.9218	-227.3719	-0.02	2.1978	-23.4469	-48.5333	-227.535	-33.0275	-35.3104	-227.2089
4.336	-28.9199	-40.2911	-228.1161	-0.1245	2.1958	-25.1583	-45.5049	-228.9208	-32.6816	-35.0772	-227.3114
4.352	-28.4791	-40.7107	-228.7018	-0.1701	2.1704	-25.1785	-45.5392	-229.7064	-31.7796	-35.8821	-227.6972
4.368	-29.6245	-40.0952	-228.7989	-0.3309	2.1206	-27.2946	-43.897	-230.3305	-31.9544	-36.2934	-227.2673
4.384	-30.402	-39.9062	-229.7296	-0.3474	2.1598	-27.8314	-43.754	-231.4054	-32.9726	-36.0584	-228.0539
4.4	-30.9117	-40.0756	-229.5678	-0.2717	2.0646	-28.3193	-44.8916	-231.0916	-33.5041	-35.2597	-228.044
4.416	-30.9114	-39.4036	-230.5419	-0.4242	2.0328	-29.0877	-43.0657	-232.3895	-32.7351	-35.7415	-228.6943
4.432	-30.6764	-39.4229	-230.8324	-0.448	1.89	-29.3878	-43.3219	-232.8058	-31.965	-35.524	-228.859
4.448	-31.4693	-39.1607	-231.1781	-0.3923	1.8809	-30.0825	-43.4887	-233.0588	-32.8561	-34.8327	-229.2975
4.464	-32.2401	-38.2925	-232.0822	-0.431	1.8152	-31.2241	-42.3667	-234.0129	-33.2561	-34.2182	-230.1515
4.48	-32.2398	-38.3025	-232.1034	-0.5581	1.7621	-31.5239	-41.9997	-234.4545	-32.9556	-34.6053	-229.7523
4.496	-32.592	-37.816	-232.9634	-0.5608	1.8065	-31.6238	-41.8481	-235.5679	-33.5602	-33.7839	-230.3589
4.512	-33.5945	-37.2353	-233.8126	-0.5486	1.7624	-32.7909	-41.3774	-236.3915	-34.3981	-33.0931	-231.2337
4.528	-32.6707	-37.6793	-234.2669	-0.4822	1.7327	-31.9486	-42.0992	-236.6107	-33.3928	-33.2594	-231.9231
4.544	-33.1665	-36.9213	-234.9702	-0.6957	1.426	-33.6409	-40.1754	-237.7159	-32.6921	-33.6673	-232.2245
4.56	-33.4554	-36.8355	-235.5173	-0.6392	1.5343	-33.6054	-40.9392	-238.5697	-33.3055	-32.7319	-232.4649
4.576	-34.2625	-36.657	-235.8589	-0.5928	1.5595	-34.3069	-40.5738	-238.4978	-34.2181	-32.7402	-233.2201
4.592	-33.6948	-36.346	-236.8869	-0.5975	1.6608	-33.3356	-40.3277	-239.6071	-34.054	-32.3643	-234.1666
4.608	-33.2435	-36.6202	-236.8931	-0.4249	1.6836	-32.7288	-41.165	-238.9624	-33.7582	-32.0754	-234.8237
4.624	-35.4894	-34.9357	-238.4377	-0.5148	1.5723	-35.4833	-38.9961	-240.7347	-35.4955	-30.8753	-236.1408
4.64	-34.084	-35.7406	-238.3605	-0.5029	1.5009	-34.3439	-39.4523	-240.4071	-33.8241	-32.0289	-236.3139
4.656	-34.7789	-35.0267	-239.1414	-0.5197	1.5793	-34.7458	-38.9213	-241.37	-34.8121	-31.1321	-236.9129
4.672	-33.8938	-35.7374	-239.3356	-0.4384	1.6284	-33.6483	-39.9928	-241.3341	-34.1394	-31.4819	-237.3371
4.688	-34.6056	-35.7174	-240.0122	-0.4959	1.3947	-35.2797	-39.5051	-242.0937	-33.9314	-31.9296	-237.9307
4.704	-34.8452	-35.7674	-239.7883	-0.2361	-0.7156	-40.1875	-31.1228	-241.4911	-29.5028	-40.412	-238.0855
4.72	-34.482	-35.226	-241.0343	-0.281	-0.7798	-38.9584	-30.7989	-242.8515	-30.0055	-39.653	-239.2171

Rock7											
time	pos(x)	pos(y)	pos(z)	el	az	x1	y1	z1	x2	y2	z2
4.736	-35.54	-35.1019	-241.5951	-0.316	-0.6577	-40.8452	-31.0036	-243.7869	-30.2348	-39.2001	-239.4034
4.752	-35.5372	-35.2639	-242.0733	-0.3346	-0.6535	-40.3081	-31.6108	-244.1622	-30.7664	-38.9171	-239.9845
4.768	-35.6393	-35.0588	-242.3904	-0.3476	-0.6591	-41.0324	-30.8813	-244.8621	-30.2461	-39.2363	-239.9188
4.784	-36.4133	-33.8668	-243.7691	-0.3663	-0.6311	-42.0146	-29.7737	-246.4301	-30.812	-37.9598	-241.1081
4.8	-36.6672	-34.0054	-244.6194	-0.3439	-0.6658	-41.8867	-29.9058	-246.996	-31.4477	-38.1049	-242.2428
4.816	-36.154	-34.1386	-244.8708	-0.364	-0.639	-41.138	-30.4353	-247.2367	-31.17	-37.8419	-242.505
4.832	-36.591	-33.5643	-246.0594	-0.3477	-0.6358	-41.9861	-29.5826	-248.4893	-31.1959	-37.5461	-243.6295
4.848	-36.4226	-33.3985	-246.7938	-0.3857	-0.6892	-41.5767	-29.152	-249.5054	-31.2686	-37.6451	-244.0822
4.864	-36.1733	-33.7892	-246.988	-0.3601	-0.6536	-41.5024	-29.7079	-249.5152	-30.8441	-37.8706	-244.4608
4.88	-35.9211	-33.9376	-247.4447	-0.3875	-0.6804	-41.3638	-29.5329	-250.3026	-30.4784	-38.3423	-244.5867
4.896	-36.3561	-33.6322	-248.6427	-0.3507	-0.6614	-41.1687	-29.8863	-250.8737	-31.5435	-37.378	-246.4117
4.912	-35.6904	-33.8888	-249.3445	-0.3936	-0.7766	-40.1949	-29.4631	-251.9667	-31.1858	-38.3146	-246.7223

Rockan8											
time	pos(x)	pos(y)	pos(z)	el	az	x1	y1	z1	x2	y2	z2
0	0	0	0	-1.1762	0.3083	-2.1319	-0.679	-5.3722	2.1319	0.679	5.3722
0.016	-0.055	-0.6958	-4.8968	-0.9357	0.1253	-3.4634	-1.1249	-9.558	3.3534	-0.2666	-0.2357
0.032	-1.6715	-1.2058	-8.4848	-0.5665	-0.0292	-6.7395	-1.058	-11.7095	3.3964	-1.3536	-5.2602
0.048	-3.3071	-1.3344	-11.6042	-0.2851	0.184	-8.4481	-2.291	-13.1369	1.8338	-0.3778	-10.0715
0.064	-4.8433	-1.1038	-13.3816	-0.0455	0.1322	-10.8398	-1.9013	-13.6572	1.1532	-0.3064	-13.1061
0.08	-5.2984	-2.0146	-16.3695	0.1482	0.2034	-10.3134	-3.0487	-15.6049	-0.2833	-0.9805	-17.1341
0.096	-6.8155	-0.8557	-15.029	0.8142	0.0754	-10.7247	-1.151	-10.876	-2.9063	-0.5604	-19.1182
0.112	-6.6799	-2.0749	-19.5172	0.9927	0.2294	-8.9826	-2.6124	-15.8935	-4.3773	-1.5373	-23.141
0.128	-7.0243	-2.8419	-22.7109	1.0967	1.1292	-7.5846	-4.0271	-20.1561	-6.464	-1.6567	-25.2658
0.144	-6.5286	-3.2424	-24.0961	0.6555	1.6184	-6.4406	-5.0903	-22.6737	-6.6166	-1.3946	-25.5186
0.16	-7.2188	-2.4325	-23.8853	0.248	1.6774	-6.9772	-4.6898	-23.3106	-7.4603	-0.1752	-24.4601
0.176	-7.6986	-2.078	-25.6345	1.0309	1.8274	-7.3049	-3.5787	-23.0459	-8.0924	-0.5773	-28.2232
0.192	-7.8864	-2.1195	-26.454	1.2458	2.4023	-6.994	-2.9331	-22.8697	-8.7789	-1.3058	-30.0384
0.208	-7.6971	-1.8551	-27.7233	1.3253	2.5542	-6.8809	-2.3985	-23.8096	-8.5134	-1.3116	-31.6369
0.224	-7.8736	-3.2195	-31.0742	1.3699	-2.4676	-6.923	-2.4603	-25.1015	-8.8242	-3.9788	-37.0468
0.24	-7.7641	-2.6163	-31.5022	1.3087	-3.0987	-6.4039	-2.5579	-26.4265	-9.1243	-2.6747	-36.578
0.256	-7.5636	-2.9363	-33.0438	1.271	-2.6972	-5.9778	-2.1812	-27.3612	-9.1495	-3.6915	-38.7263
0.272	-7.7378	-2.7618	-34.1389	1.3686	-2.1899	-6.9298	-1.6278	-27.3484	-8.5458	-3.8957	-40.9295
0.288	-7.9919	-2.8257	-35.3993	1.3926	-2.2304	-7.2844	-1.9133	-28.9899	-8.6995	-3.7382	-41.8087
0.304	-7.9586	-3.3927	-38.1871	1.3725	-2.2534	-7.1382	-2.3837	-31.7151	-8.7791	-4.4018	-44.659
0.32	-8.4945	-3.2595	-40.1465	1.3355	-2.4483	-7.3753	-2.3295	-34.0762	-9.6136	-4.1895	-46.2167
0.336	-8.5173	-3.3466	-41.5282	1.389	-2.4297	-7.6495	-2.5978	-35.294	-9.3851	-4.0954	-47.7623
0.352	-8.5356	-4.2228	-44.417	1.3878	-2.0316	-7.9354	-3.0138	-37.1255	-9.1357	-5.4317	-51.7084
0.368	-8.6133	-3.8491	-45.5922	1.4627	-2.6965	-7.999	-3.5561	-39.3209	-9.2276	-4.1422	-51.8635
0.384	-8.7806	-4.3089	-48.0188	1.3616	-3.0659	-7.4579	-4.2086	-41.7713	-10.1032	-4.4092	-54.2664
0.4	-8.754	-4.531	-50.113	1.2244	3.1115	-6.7352	-4.5917	-44.5177	-10.7728	-4.4703	-55.7084
0.416	-9.0301	-4.5411	-51.8562	1.3826	3.1144	-7.8918	-4.572	-45.8755	-10.1684	-4.5102	-57.8369
0.432	-8.9715	-4.7587	-53.8591	1.3675	-3.0392	-7.6713	-4.6252	-47.52	-10.2718	-4.8923	-60.1983
0.448	-9.211	-5.1031	-55.8327	1.3113	-2.6035	-7.7694	-4.2427	-49.5081	-10.6525	-5.9636	-62.1574
0.464	-8.8446	-5.3234	-57.7265	1.2979	-2.774	-7.2066	-4.6926	-51.4555	-10.4826	-5.9542	-63.9974
0.48	-8.7909	-5.6348	-60.0907	1.3046	-2.7325	-7.1983	-4.9443	-53.724	-10.3834	-6.3253	-66.4573
0.496	-9.1527	-6.2141	-62.0342	1.2795	-2.6609	-7.4615	-5.3321	-55.6737	-10.8439	-7.0961	-68.3948
0.512	-9.6353	-6.5254	-64.2999	1.2303	-2.7664	-7.5957	-5.7221	-58.1136	-11.6749	-7.3287	-70.4862
0.528	-10.2598	-6.5927	-66.0709	1.2295	-2.6236	-8.4284	-5.5489	-60.1356	-12.0911	-7.6365	-72.0063
0.544	-10.0183	-7.2158	-68.0024	1.2309	-2.361	-8.3907	-5.6037	-61.523	-11.6459	-8.8279	-74.4817
0.56	-10.3619	-7.5306	-70.3195	1.227	-2.4444	-8.499	-5.9706	-63.532	-12.2247	-9.0907	-77.107
0.576	-10.4113	-8.1923	-72.4838	1.209	-2.0525	-9.2409	-5.9534	-65.8081	-11.5817	-10.4312	-79.1595
0.592	-10.6609	-8.1493	-74.4473	1.2142	-2.4349	-8.8101	-6.5692	-67.915	-12.5117	-9.7293	-80.9797
0.608	-10.7044	-8.4734	-76.2114	1.1865	-2.4372	-8.7682	-6.8279	-69.9281	-12.6406	-10.1188	-82.4947
0.624	-10.7983	-9.3852	-78.3076	1.163	-2.3158	-8.7551	-7.1697	-71.3312	-12.8416	-11.6008	-85.2839
0.64	-10.8835	-10.1616	-80.935	1.1334	-2.3088	-8.7926	-7.8624	-74.2893	-12.9744	-12.4609	-87.5806
0.656	-10.5772	-10.941	-83.5291	1.1454	-2.0911	-8.9321	-8.0697	-76.2242	-12.2223	-13.8124	-90.834
0.672	-10.725	-11.951	-85.211	1.1279	-2.0869	-9.143	-9.1629	-78.4528	-12.3069	-14.739	-91.9692
0.688	-11.0398	-12.3317	-86.7778	1.0969	-2.0142	-9.6066	-9.3137	-80.263	-12.473	-15.3496	-93.2926
0.704	-12.4887	-12.809	-89.2943	0.9755	-1.8559	-11.4198	-9.1619	-83.6828	-13.5576	-16.4561	-94.9059
0.72	-12.4759	-13.0568	-90.5907	0.9507	-1.5267	-12.6501	-9.1084	-85.0563	-12.3017	-17.0052	-96.1252
0.736	-12.9649	-13.6985	-92.5919	0.9146	-1.5025	-13.2567	-9.434	-87.0405	-12.6732	-17.9629	-98.1433
0.752	-12.8716	-14.6683	-94.5781	0.8393	-1.3748	-13.6942	-10.5254	-89.8721	-12.049	-18.8112	-99.284
0.768	-13.9702	-15.0978	-95.8737	0.6832	-1.2415	-15.6966	-10.0453	-91.5273	-12.2438	-20.1502	-100.22
0.784	-13.0983	-15.5767	-97.41	0.6568	-1.2088	-14.9481	-10.6915	-93.3828	-11.2484	-20.4618	-101.4372

Rock8

time	pos(x)	pos(y)	pos(z)	el	az	x1	y1	z1	x2	y2	z2
0.8	-13.4125	-16.5744	-98.2665	0.5927	-1.1966	-15.2484	-11.8986	-94.8831	-11.5765	-21.2503	-101.65
0.816	-13.3704	-17.0106	-99.9611	0.4624	-1.0878	-15.6821	-12.6026	-97.48	-11.0587	-21.4187	-102.4423
0.832	-13.5511	-17.6798	-102.3306	0.4636	-1.0553	-16.1898	-13.0226	-99.6545	-10.9124	-22.3371	-105.0068
0.848	-14.406	-18.7454	-103.5587	0.3632	-1.0574	-17.0942	-13.9776	-101.4782	-11.7177	-23.5133	-105.6392
0.864	-14.8	-19.6583	-104.8165	0.3762	-0.9815	-18.3006	-14.4216	-102.3284	-11.2994	-24.8949	-107.3047
0.88	-15.5381	-20.1191	-106.13	0.3561	-0.9952	-19.1579	-14.5409	-103.6563	-11.9182	-25.6973	-108.6037
0.896	-15.5468	-20.6658	-106.7443	0.3007	-1.0258	-18.4877	-15.8148	-104.9852	-12.606	-25.5169	-108.5034
0.912	-15.646	-21.9752	-108.3605	0.301	-1.0651	-18.5902	-16.6579	-106.4737	-12.7019	-27.2926	-110.2473
0.928	-15.6785	-22.5357	-109.7643	0.1635	-0.9265	-19.0911	-17.9932	-108.8271	-12.2659	-27.0783	-110.7014
0.944	-17.6183	-23.2203	-112.0148	0.1883	-0.8103	-21.6074	-19.0272	-110.9121	-13.6292	-27.4134	-113.1174
0.96	-17.2861	-24.2259	-112.6588	0.2673	-0.9599	-20.5712	-19.5345	-111.0906	-14.0011	-28.9173	-114.2269
0.976	-17.6956	-24.679	-113.3967	0.1858	-0.8348	-21.5193	-20.4577	-112.3259	-13.8719	-28.9004	-114.4675
0.992	-18.2798	-26.527	-114.7367	0.1278	-0.4859	-23.1698	-23.9444	-114.0261	-13.3898	-29.1096	-115.4473
1.008	-17.7353	-27.3771	-115.8892	0.1257	-0.4782	-22.2082	-25.0585	-115.2528	-13.2625	-29.6957	-116.5257
1.024	-19.5117	-27.2002	-115.9749	0.146	-0.6192	-24.0745	-23.9483	-115.1509	-14.9489	-30.4521	-116.799
1.04	-18.9294	-28.3445	-116.8709	0.198	-0.4806	-24.0154	-25.6926	-115.7204	-13.8435	-30.9964	-118.0214
1.056	-18.7398	-27.814	-117.0431	0.1599	-0.3702	-23.3608	-26.0205	-116.2439	-14.1188	-29.6074	-117.8423
1.072	-17.6999	-29.3761	-117.8877	0.1788	-0.6308	-21.4546	-26.6342	-117.0476	-13.9453	-32.1181	-118.7278
1.088	-17.6494	-29.3668	-118.6788	0.1732	-0.6898	-21.0463	-26.5642	-117.9084	-14.2526	-32.1694	-119.4493
1.104	-17.2577	-29.764	-119.1258	0.2142	-0.7364	-20.8289	-26.5265	-118.077	-13.6864	-33.0015	-120.1746
1.12	-18.1556	-30.3866	-119.4238	0.2018	-0.6892	-22.8586	-26.5116	-118.1773	-13.4526	-34.2615	-120.6704
1.136	-17.9673	-29.5847	-119.231	0.4024	-0.6371	-22.6819	-26.0957	-116.7349	-13.2527	-33.0737	-121.7271
1.152	-17.964	-28.9967	-119.1671	0.3053	-0.4483	-22.5362	-26.7976	-117.5683	-13.3917	-31.1958	-118.7659
1.168	-17.8325	-30.2659	-119.8639	0.3341	-0.6124	-22.9655	-26.6596	-117.6865	-12.6995	-33.8722	-122.0413
1.184	-17.7848	-30.6131	-120.5338	0.3508	-0.4792	-22.7943	-28.0102	-118.468	-12.7753	-33.2159	-122.5997
1.2	-18.1964	-31.7179	-121.1559	0.3405	-0.4765	-24.1645	-28.6377	-118.7765	-12.2284	-34.7982	-123.5352
1.216	-18.4346	-31.5575	-121.6622	0.4022	-0.4094	-23.9709	-29.155	-119.0949	-12.8982	-33.96	-124.2294
1.232	-18.315	-31.948	-122.0501	0.3889	-0.4825	-24.3006	-28.8131	-119.2815	-12.3294	-35.0829	-124.8187
1.248	-17.8244	-32.316	-122.6389	0.3654	-0.3784	-23.1583	-30.1956	-120.4429	-12.4905	-34.4364	-124.835
1.264	-18.4292	-32.3752	-123.4372	0.3755	-0.4064	-23.9722	-29.9895	-121.058	-12.8861	-34.7609	-125.8164
1.28	-17.9279	-32.5674	-123.4861	0.4094	-0.4619	-23.5243	-29.781	-120.7736	-12.3315	-35.3537	-126.1986
1.296	-18.4901	-32.8296	-123.6004	0.4489	-0.4125	-23.7357	-30.534	-120.8421	-13.2445	-35.1252	-126.3587
1.312	-18.4673	-33.4359	-124.3867	0.4638	-0.4312	-24.4251	-30.6952	-121.1063	-12.5094	-36.1767	-127.6672
1.328	-18.0756	-34.1134	-125.1507	0.3773	-0.3667	-23.5583	-32.0078	-122.8234	-12.5928	-36.2189	-127.478
1.344	-17.9025	-34.2343	-125.2405	0.3943	-0.4142	-23.7553	-31.6613	-122.5807	-12.0497	-36.8074	-127.9004
1.36	-17.2295	-35.2395	-126.594	0.451	-0.5406	-22.8648	-31.8988	-123.4506	-11.7341	-38.5803	-129.7373
1.376	-17.6487	-34.7716	-127.0556	0.4546	-0.5285	-23.3677	-31.4322	-123.8192	-11.9296	-38.111	-130.292
1.392	-17.6758	-34.5217	-126.7248	0.271	-0.4542	-23.2918	-31.78	-124.9887	-12.0599	-37.2634	-128.461
1.408	-16.8643	-35.4266	-128.0823	0.2657	-0.4552	-22.1535	-32.8379	-126.48	-11.5752	-38.0152	-129.6847
1.424	-16.7398	-35.4673	-128.5942	0.3191	-0.4782	-21.842	-32.8226	-126.6956	-11.6376	-38.112	-130.4929
1.44	-17.3509	-34.883	-128.5486	0.3311	-0.4201	-23.0908	-32.3192	-126.3879	-11.6109	-37.4469	-130.7093
1.456	-16.6189	-35.3789	-129.6375	0.2647	-0.4999	-21.9614	-32.4612	-127.9875	-11.2764	-38.2967	-131.2875
1.472	-16.8056	-35.5821	-129.8899	0.1679	-0.6222	-22.3765	-31.5864	-128.7277	-11.2348	-39.5777	-131.0521
1.488	-15.8289	-36.8425	-131.7864	0.0559	-0.2904	-20.779	-35.3634	-132.0756	-10.8789	-38.3217	-131.4972
1.504	-15.3671	-37.5452	-132.4191	-0.0725	-0.3938	-19.9067	-35.6592	-132.776	-10.8275	-39.4312	-132.0622
1.52	-15.2347	-38.0056	-133.8029	-0.0182	-0.4006	-20.0583	-35.9628	-133.8981	-10.411	-40.0484	-133.7078
1.536	-14.7008	-37.6567	-133.735	-0.0249	-0.3738	-19.5599	-35.7505	-133.8651	-9.8416	-39.5629	-133.6049
1.552	-14.3404	-37.3957	-134.3853	-0.0727	-0.3537	-19.3883	-35.5322	-134.7771	-9.2925	-39.2593	-133.9935
1.568	-14.1795	-37.9069	-134.9558	-0.1046	-0.3105	-18.936	-36.3807	-135.4799	-9.4231	-39.433	-134.4316
1.584	-13.6587	-37.9451	-135.1635	-0.0419	-0.518	-18.4333	-35.224	-135.3939	-8.8841	-40.6661	-134.933
1.6	-13.2835	-38.4364	-136.5613	-0.2978	-0.2743	-17.3888	-37.2814	-137.87	-9.1782	-39.5915	-135.2525
1.616	-13.0892	-38.4117	-137.3012	-0.1974	-0.4733	-17.4676	-36.1692	-138.2853	-8.7108	-40.6542	-136.317
1.632	-12.95	-38.6403	-137.1737	-0.2874	-0.4144	-17.0196	-36.8502	-138.4878	-8.8804	-40.4304	-135.8596
1.648	-12.5669	-38.7436	-137.6567	-0.1865	-0.5421	-16.7243	-36.2399	-138.5722	-8.4096	-41.2473	-136.7411
1.664	-12.6504	-37.8421	-138.4414	-0.2478	-0.5839	-16.487	-35.3072	-139.6046	-8.8138	-40.3771	-137.2782
1.68	-12.7025	-36.7851	-138.1869	-0.2961	-0.483	-16.9677	-34.5483	-139.656	-8.4373	-39.0219	-136.7178
1.696	-12.2941	-37.3417	-139.287	-0.2662	-0.6581	-16.1223	-34.3823	-140.6063	-8.4659	-40.3012	-137.9676
1.712	-11.6691	-38.3761	-139.6268	-0.2956	-0.5581	-15.1399	-36.2091	-140.8728	-8.1983	-40.5431	-138.3807
1.728	-12.0538	-37.6293	-139.5212	-0.2207	-0.8177	-16.1354	-33.2751	-140.8605	-7.9722	-41.9835	-138.182
1.744	-10.9146	-39.5711	-140.3283	-0.3957	-0.6877	-14.0035	-37.0335	-141.9982	-7.8257	-42.1087	-138.6585
1.76	-10.4783	-39.1979	-140.4875	-0.342	-0.8547	-12.9475	-36.3606	-141.8265	-8.0091	-42.0353	-139.1486
1.776	-11.7508	-37.6393	-140.7997	-0.19	-0.7309	-15.9043	-33.9159	-141.8728	-7.5973	-41.3627	-139.7267
1.792	-11.085	-38.0796	-141.1915	-0.1568	-0.9412	-13.4554	-34.8261	-141.828	-8.7147	-41.333	-140.555
1.808	-10.4808	-38.8303	-141.6408	-0.21	-0.937	-12.7534	-35.7384	-142.4587	-8.2083	-41.9223	-140.8229
1.824	-11.2123	-38.4338	-142.1613	-0.118	-0.8077	-14.1634	-35.3479	-142.6677	-8.2611	-41.5197	-141.6549
1.84	-11.3179	-39.0597	-142.4325	-0.0854	-0.8955	-14.738	-34.7894	-142.901	-7.8977	-43.3301	-141.9641

Rock8

time	pos(x)	pos(y)	pos(z)	el	az	x1	y1	z1	x2	y2	z2
1.856	-11.3349	-38.6819	-143.0817	-0.1193	-0.8017	-14.5212	-35.3899	-143.631	-8.1486	-41.9739	-142.5323
1.872	-10.8323	-38.415	-143.7075	-0.0883	-0.7261	-14.6362	-35.0376	-144.158	-7.0284	-41.7924	-143.2571
1.888	-11.1504	-38.5217	-144.1164	-0.0314	-0.8813	-14.2935	-34.7092	-144.2718	-8.0073	-42.3342	-143.961
1.904	-11.3017	-38.1776	-144.2919	-0.0234	-0.8526	-14.9739	-33.9753	-144.4225	-7.6296	-42.3799	-144.1612
1.92	-11.3054	-37.5029	-144.6154	-0.0081	-0.8579	-15.3052	-32.8762	-144.6649	-7.3057	-42.1296	-144.5658
1.936	-11.2732	-37.2694	-144.5083	0.0951	-0.8607	-14.719	-33.2608	-144.0039	-7.8273	-41.2781	-145.0127
1.952	-11.5711	-37.6615	-145.2504	0.1727	-0.9234	-15.0957	-32.9999	-144.2307	-8.0464	-42.3231	-146.27
1.968	-11.0586	-37.7053	-145.2861	0.1096	-0.8829	-14.5228	-33.4898	-144.6857	-7.5945	-41.9207	-145.8865
1.984	-11.2936	-37.1045	-146.1243	0.1737	-0.896	-14.869	-32.6358	-145.1198	-7.7183	-41.5732	-147.1287
2	-10.8702	-37.9647	-146.7229	0.1959	-0.8504	-14.6403	-33.6695	-145.589	-7.1001	-42.2599	-147.8569
2.016	-10.7591	-37.8474	-147.4011	0.1442	-0.8835	-14.2091	-33.6441	-146.6112	-7.309	-42.0507	-148.191
2.032	-10.6217	-37.8015	-148.2158	0.2006	-0.799	-14.8123	-33.4953	-146.994	-6.4311	-42.1076	-149.4376
2.048	-10.9583	-37.7268	-148.5596	0.1984	-0.702	-14.8204	-34.4608	-147.5427	-7.0961	-40.9928	-149.5765
2.064	-10.8061	-37.6478	-149.1303	0.1884	-0.8479	-14.2705	-33.7204	-148.1315	-7.3416	-41.5752	-150.129
2.08	-10.6433	-37.7189	-149.3187	0.1247	-0.7446	-14.3366	-34.3155	-148.6893	-6.9499	-41.1224	-149.9481
2.096	-10.2808	-38.1513	-150.0498	0.1857	-0.692	-13.5782	-35.4188	-149.2451	-6.9834	-40.8838	-150.8545
2.112	-10.8457	-38.4995	-150.6957	0.0953	-0.7724	-14.5723	-34.8682	-150.1982	-7.1191	-42.1308	-151.1933
2.128	-10.2216	-38.5762	-150.6849	0.0921	-0.7094	-14.0268	-35.3094	-150.2215	-6.4163	-41.8429	-151.1484
2.144	-9.9146	-38.4054	-152.0954	0.3199	-0.3328	-13.476	-37.1745	-150.8471	-6.3532	-39.6362	-153.3437
2.16	-10.2027	-38.076	-152.3266	0.2605	-0.4075	-13.6435	-36.5907	-151.3274	-6.7619	-39.5612	-153.3258
2.176	-10.7891	-38.4679	-152.5497	0.0669	-0.278	-14.9252	-37.2875	-152.2615	-6.653	-39.6484	-152.8378
2.192	-11.0301	-38.0526	-153.7114	0.1228	-0.2829	-15.495	-36.7549	-153.1376	-6.5652	-39.3504	-154.2852
2.208	-10.3646	-39.0385	-155.1018	0.208	-0.3062	-14.891	-37.6077	-154.1002	-5.8383	-40.4692	-156.1035
2.224	-9.8512	-40.0119	-154.8963	0.1051	-0.2121	-14.3019	-39.0536	-154.4163	-5.4005	-40.9701	-155.3764
2.24	-10.1525	-39.0791	-155.7786	0.0631	-0.2668	-14.8092	-37.8064	-155.4736	-5.4959	-40.3517	-156.0835
2.256	-9.2375	-41.0816	-157.1412	0.0103	-0.0131	-13.2129	-41.0294	-157.1003	-5.2621	-41.1338	-157.182
2.272	-9.2163	-41.889	-157.616	0.0801	-0.0376	-12.9762	-41.7474	-157.3141	-5.4565	-42.0305	-157.9178
2.288	-8.7085	-41.5694	-157.5605	0.0117	0.0621	-12.5811	-41.8101	-157.5153	-4.8359	-41.3287	-157.6058
2.304	-8.5621	-42.6632	-158.1639	0.0916	-0.0349	-12.3482	-42.5312	-157.816	-4.776	-42.7952	-158.5119
2.32	-8.7753	-42.3916	-158.6008	0.0649	0.0532	-12.595	-42.595	-158.3523	-4.9556	-42.1882	-158.8494
2.336	-8.5275	-42.8834	-159.1821	0.1795	0.131	-12.1592	-43.3618	-158.5175	-4.8957	-42.4051	-159.8467
2.352	-8.2993	-43.7228	-159.6799	0.0911	0.1825	-11.7244	-44.3549	-159.3616	-4.8742	-43.0907	-159.9982
2.368	-8.4298	-43.1516	-160.4969	0.1691	0.1561	-12.0133	-43.7157	-159.8773	-4.8462	-42.5875	-161.1164
2.384	-8.0597	-43.6094	-160.8753	0.2149	0.2426	-11.5856	-44.4821	-160.0825	-4.5338	-42.7367	-161.668
2.4	-7.9869	-43.9202	-160.6783	0.1779	-0.0483	-11.919	-43.7301	-159.9704	-4.0547	-44.1103	-161.3863
2.416	-8.0638	-43.5921	-161.2375	0.2209	0.1807	-12.2503	-44.3571	-160.282	-3.8773	-42.827	-162.1931
2.432	-8.2088	-43.9574	-161.7442	0.3212	-0.079	-12.5003	-43.6176	-160.3117	-3.9173	-44.2971	-163.1767
2.448	-7.7313	-44.1326	-162.405	0.2807	0.4688	-11.4262	-46.004	-161.2108	-4.0365	-42.2612	-163.5992
2.464	-7.7745	-44.124	-162.5204	0.2998	0.4487	-11.6091	-45.9702	-161.205	-3.9399	-42.2779	-163.8359
2.48	-7.1064	-44.4843	-163.6882	0.2448	0.3124	-10.8941	-45.7076	-162.6937	-3.3187	-43.2611	-164.6826
2.496	-7.0721	-44.4814	-163.6463	0.3766	0.3038	-10.752	-45.6351	-162.1213	-3.3923	-43.3277	-165.1713
2.512	-6.7636	-44.8957	-163.9144	0.3042	0.3805	-10.5098	-46.3941	-162.6476	-3.0174	-43.3973	-165.1812
2.528	-7.4247	-44.6809	-165.0287	0.4371	0.0982	-11.1838	-45.0513	-163.2638	-3.6655	-44.3105	-166.7935
2.544	-7.8469	-43.108	-164.7314	0.3576	0.1109	-11.7597	-43.5437	-163.2605	-3.934	-42.6723	-166.2023
2.56	-7.6139	-43.9876	-165.3388	0.314	-0.2285	-11.8275	-43.0075	-163.9339	-3.4003	-44.9677	-166.7436
2.576	-7.1357	-43.8399	-166.1455	0.2587	0.027	-11.4192	-43.9558	-165.0114	-2.8521	-43.724	-167.2795
2.592	-6.8614	-44.9117	-166.1694	0.2241	-0.2086	-11.2298	-43.9872	-165.1516	-2.493	-45.8362	-167.1872
2.608	-7.3216	-43.6071	-167.2346	0.1998	-0.1951	-11.9937	-42.6836	-166.2699	-2.6494	-44.5307	-168.1992
2.624	-7.1479	-44.777	-167.7782	0.0985	0.1158	-10.7283	-45.1934	-167.422	-3.5674	-44.3606	-168.1343
2.64	-6.4715	-45.5712	-167.8136	-0.0799	-0.0793	-10.8945	-45.2197	-168.1688	-2.0485	-45.9226	-167.4583
2.656	-6.2332	-44.7877	-169.3338	-0.0682	0.0038	-10.3943	-44.8036	-169.6179	-2.0721	-44.7718	-169.0497
2.672	-6.6779	-45.7113	-168.9357	-0.1322	-0.065	-10.8972	-45.4368	-169.4981	-2.4586	-45.9857	-168.3734
2.688	-5.9912	-46.9952	-169.9619	-0.09	-0.1574	-10.0023	-46.3584	-170.3282	-1.9802	-47.6319	-169.5955
2.704	-6.3345	-46.9539	-170.4108	-0.1841	-0.1518	-10.2632	-46.3527	-171.1506	-2.4058	-47.5551	-169.6709
2.72	-6.0193	-46.0009	-170.8361	-0.1211	0.1201	-9.7215	-46.4479	-171.2898	-2.317	-45.554	-170.3825
2.736	-5.3451	-46.864	-171.2317	-0.2081	-0.0688	-9.1633	-46.6011	-172.04	-1.5269	-47.127	-170.4234
2.752	-5.1787	-47.8346	-171.6346	-0.1724	-0.0468	-8.7712	-46.6664	-172.2607	-1.5861	-48.0028	-171.0085
2.768	-4.8487	-48.477	-172.1659	-0.1937	-0.0857	-8.1234	-48.1958	-172.8104	-1.5741	-48.7583	-171.5213
2.784	-5.0746	-47.9761	-172.8833	-0.2601	-0.0899	-8.6893	-47.6502	-173.8493	-1.46	-48.302	-171.9174
2.8	-4.9256	-48.1191	-173.1726	-0.2997	-0.1126	-8.4186	-47.7242	-174.259	-1.4326	-48.5141	-172.0863
2.816	-5.4285	-47.7341	-173.8732	-0.2858	-0.0143	-9.0945	-47.6817	-174.9507	-1.7624	-47.7864	-172.7957
2.832	-4.6716	-49.0324	-174.0244	-0.4304	-0.0113	-7.8174	-48.997	-175.4689	-1.5258	-49.0679	-172.5799
2.848	-4.5882	-48.592	-175.1428	-0.4093	-0.1303	-8.0569	-48.1373	-176.6605	-1.1194	-49.0467	-173.625
2.864	-4.9279	-48.6124	-175.1805	-0.4363	-0.2042	-8.2839	-47.9173	-176.7785	-1.5718	-49.3074	-173.5825
2.88	-4.486	-48.7381	-175.8635	-0.4607	-0.3655	-7.6406	-47.5308	-177.54	-1.3315	-49.9453	-174.1869
2.896	-4.5206	-48.4869	-176.3618	-0.5124	-0.4817	-7.6533	-46.8494	-178.3502	-1.3879	-50.1244	-174.3733

Rock8

time	pos(x)	pos(y)	pos(z)	el	az	x1	y1	z1	x2	y2	z2
2.912	-4.0141	-48.3159	-176.4675	-0.5169	-0.5247	-6.9418	-46.6213	-178.3905	-1.0865	-50.0106	-174.5444
2.928	-4.0601	-48.1863	-177.2484	-0.4908	-0.4321	-7.0718	-46.7975	-179.0206	-1.0484	-49.5751	-175.4763
2.944	-3.9556	-48.2796	-177.6471	-0.5443	-0.7338	-6.9353	-45.5923	-180.076	-0.976	-50.9668	-175.2182
2.96	-3.9787	-48.4868	-178.0261	-0.5788	-0.5799	-6.6694	-46.7244	-180.128	-1.2879	-50.2493	-175.9242
2.976	-3.7694	-48.6126	-178.59	-0.5327	-0.8401	-6.7498	-45.2869	-181.223	-0.789	-51.9382	-175.957
2.992	-3.9272	-47.5558	-179.7795	-0.4764	-0.8522	-7.0586	-43.9755	-182.2342	-0.7959	-51.1361	-177.3249
3.008	-4.0093	-48.2735	-179.8161	-0.4281	-0.8846	-6.7463	-44.9317	-181.7875	-1.2724	-51.6154	-177.8447
3.024	-3.373	-48.395	-180.417	-0.4656	-0.9691	-6.1712	-44.3199	-182.901	-0.5749	-52.47	-177.9331
3.04	-3.805	-47.242	-180.914	-0.4534	-1.0578	-6.1616	-43.0585	-183.2537	-1.4484	-51.4254	-178.5744
3.056	-3.5379	-48.3869	-181.3586	-0.3714	-1.1057	-5.8183	-43.8429	-183.3385	-1.2575	-52.931	-179.3788
3.072	-3.5492	-47.8465	-181.8181	-0.4182	-1.1426	-5.5179	-43.5333	-183.9251	-1.5805	-52.1596	-179.711
3.088	-3.8185	-46.6332	-182.3414	-0.3507	-1.1904	-5.9563	-41.2862	-184.4483	-1.6807	-51.9803	-180.2346
3.104	-3.5455	-46.8664	-183.0745	-0.2942	-1.191	-5.7627	-41.3121	-184.8868	-1.3282	-52.4207	-181.2622
3.12	-4.2068	-47.1041	-183.811	-0.2336	-1.1487	-6.4651	-42.075	-185.1229	-1.9484	-52.1333	-182.499
3.136	-3.9281	-46.799	-184.088	-0.1604	-1.1699	-6.2115	-41.411	-185.0349	-1.6447	-52.1871	-183.1411
3.152	-3.6491	-47.2002	-184.7262	-0.1396	-1.2782	-5.523	-40.9804	-185.6392	-1.7753	-53.4199	-183.8131
3.168	-3.8285	-46.9855	-184.9035	-0.1019	-1.2959	-5.5212	-40.9838	-185.5413	-2.1358	-52.9871	-184.2656
3.184	-3.8596	-46.5082	-185.6798	-0.0874	-1.1655	-6.3836	-40.6247	-186.2408	-1.3356	-52.3917	-185.1189
3.2	-4.8958	-45.3212	-185.8685	-0.0585	-1.1645	-7.8062	-38.5574	-186.2994	-1.9854	-52.0851	-185.4375
3.216	-4.8666	-45.5799	-186.4649	-0.0719	-1.152	-7.8424	-38.895	-186.9918	-1.8909	-52.2648	-185.938
3.232	-4.6374	-45.9821	-186.7159	-0.0928	-1.1661	-7.4108	-39.508	-187.3711	-1.864	-52.4562	-186.0608
3.248	-5.1876	-44.4191	-188.1952	0.0054	-1.1348	-7.9465	-38.4982	-188.1602	-2.4288	-50.3399	-188.2301
3.264	-3.6813	-45.4074	-188.4985	0.0334	-1.3203	-5.9094	-36.6982	-188.1979	-1.4532	-54.1166	-188.799
3.28	-3.7649	-44.6738	-188.8411	0.162	-1.2998	-5.7512	-37.5245	-187.6281	-1.7786	-51.8232	-190.0542
3.296	-4.7678	-42.9977	-189.2659	0.2909	-1.2684	-6.7509	-36.642	-187.2726	-2.7847	-49.3534	-191.2593
3.312	-4.6908	-42.667	-189.3206	0.2185	-1.1971	-7.1034	-36.5143	-187.8534	-2.2783	-48.8197	-190.7879
3.328	-4.4142	-44.7656	-190.2499	0.3551	-1.2416	-6.4498	-38.8076	-187.9148	-2.3787	-50.2736	-192.5849
3.344	-4.6083	-44.3782	-190.4014	0.2415	-1.2908	-6.6411	-37.3087	-188.5899	-2.5755	-51.4477	-192.213
3.36	-4.592	-43.954	-191.2689	0.34	-1.2125	-6.8345	-37.966	-189.007	-2.3495	-49.942	-193.5308
3.376	-4.7995	-43.194	-191.666	0.1994	-1.2229	-7.2676	-36.3889	-190.203	-2.3314	-49.9992	-193.1289
3.392	-4.4553	-43.6088	-191.7732	0.2862	-1.2501	-6.5579	-37.279	-189.8107	-2.3528	-49.9385	-193.7357
3.408	-4.3399	-44.6797	-192.0113	0.332	-1.2239	-6.4883	-38.737	-189.8329	-2.1915	-50.6223	-194.1897
3.424	-4.8838	-43.0392	-193.3127	0.2266	-1.2391	-7.2047	-36.2996	-191.6691	-2.5628	-49.7788	-194.9562
3.44	-5.0147	-42.2336	-194.1137	0.4418	-1.1617	-7.2606	-37.053	-191.4432	-2.7689	-47.4141	-196.7842
3.456	-4.7094	-42.6297	-194.6224	0.1817	-1.2086	-7.148	-36.1947	-193.3578	-2.2708	-49.0647	-195.887
3.472	-4.5799	-42.8687	-195.6647	0.1682	-1.2453	-7.3421	-34.6844	-194.1977	-1.8178	-51.053	-197.1317
3.488	-4.8095	-42.866	-195.4781	0.2963	-1.1573	-7.4454	-36.8592	-193.4752	-2.1736	-48.8727	-197.481
3.504	-4.6562	-43.6043	-195.886	0.1989	-1.1565	-7.3374	-37.507	-194.5433	-1.975	-49.7016	-197.2287
3.52	-4.6704	-42.8824	-196.2594	0.577	-1.1349	-6.9727	-37.939	-192.7096	-2.368	-47.8258	-199.8091
3.536	-4.8152	-42.4831	-198.5484	0.2341	-1.2308	-7.6303	-34.5244	-196.5351	-2.0001	-50.4417	-200.5616
3.552	-4.5957	-42.9202	-198.9073	0.3092	-1.1768	-6.858	-37.479	-197.025	-2.3334	-48.3614	-200.7897
3.568	-4.4571	-44.129	-198.3805	0.2907	-1.175	-6.869	-38.3577	-196.509	-2.0453	-49.9002	-200.252
3.584	-4.5899	-43.6305	-199.4503	0.0513	-1.2594	-6.8453	-36.6239	-199.0721	-2.3345	-50.6371	-199.8285
3.6	-4.8995	-41.4051	-200.1079	0.1475	-1.2461	-7.6946	-33.1007	-198.806	-2.1043	-49.7096	-201.4098
3.616	-4.816	-43.0687	-200.6497	0.0867	-1.2869	-7.1385	-35.1098	-199.9294	-2.4935	-51.0275	-201.3701
3.632	-4.8274	-42.9852	-201.5735	0.0728	-1.2152	-7.0419	-37.0218	-201.1095	-2.6129	-48.9486	-202.0376
3.648	-4.7709	-44.1538	-202.3242	0.0751	-1.312	-7.2201	-34.9002	-201.604	-2.3216	-53.4074	-203.0445
3.664	-4.4249	-44.9725	-202.5195	-0.0419	-1.2744	-6.9097	-36.8358	-202.876	-1.9401	-53.1093	-202.1629
3.68	-4.5577	-45.4509	-203.4167	0.0762	-1.2479	-6.7182	-38.9941	-202.8971	-2.3972	-51.9078	-203.9363
3.696	-4.7172	-44.6721	-203.882	0.0864	-1.2234	-7.3151	-37.498	-203.2208	-2.1194	-51.8463	-204.5432
3.712	-4.7775	-43.6228	-204.2715	0.1375	-1.2133	-7.5608	-36.1708	-203.1712	-1.9943	-51.0748	-205.3719
3.728	-4.2061	-47.132	-205.6844	-0.0418	-1.3224	-6.3509	-38.6765	-206.0495	-2.0614	-55.5874	-205.3192
3.744	-4.3005	-46.5348	-206.2823	-0.0811	-1.3149	-6.3991	-38.5136	-206.9565	-2.2019	-54.5559	-205.6082
3.76	-4.2522	-45.576	-207.5285	-0.1402	-1.3172	-5.9582	-38.9941	-208.4883	-2.5462	-52.1579	-206.5688
3.776	-3.4395	-45.9041	-208.2701	-0.179	-1.3872	-4.6508	-39.3803	-209.4707	-2.2282	-52.4279	-207.0695
3.792	-2.8921	-46.4075	-209.2113	-0.2628	-1.3727	-4.2057	-39.8627	-211.0074	-1.5785	-52.9522	-207.4152
3.808	-2.9733	-47.7121	-209.1645	-0.2013	-1.3653	-4.6339	-39.7452	-210.8248	-1.3127	-55.679	-207.5042
3.824	-4.2034	-47.5002	-209.3182	-0.1561	-1.3517	-5.8247	-40.2199	-210.4921	-2.5821	-54.7805	-208.1444
3.84	-3.4639	-47.4596	-210.1014	-0.2913	-1.3144	-5.6073	-39.2827	-212.6361	-1.3205	-55.6364	-207.5667
3.856	-3.7269	-47.1148	-210.7667	-0.2617	-1.2785	-5.9848	-39.6117	-212.8657	-1.4691	-54.6179	-208.6678
3.872	-3.4219	-48.9235	-210.9431	-0.2821	-1.3696	-5.1131	-40.6315	-213.396	-1.7307	-57.2155	-208.4902
3.888	-3.5564	-48.245	-211.5192	-0.2798	-1.3188	-5.3963	-41.0986	-213.6396	-1.7164	-55.3914	-209.3988
3.904	-3.857	-49.6691	-211.955	-0.3094	-1.3355	-5.6219	-42.3081	-214.3749	-2.0921	-57.0301	-209.535
3.92	-2.7579	-51.8336	-211.8997	-0.3228	-1.3824	-4.2385	-44.0694	-214.5437	-1.2774	-59.5978	-209.2557
3.936	-2.3611	-50.1675	-212.3341	-0.3802	-1.3355	-3.9619	-43.4905	-215.078	-0.7603	-56.8446	-209.5902
3.952	-1.8449	-52.3448	-211.8137	-0.3808	-1.366	-3.4957	-44.398	-215.0628	-0.1942	-60.2916	-208.5646

Rock8

time	pos(x)	pos(y)	pos(z)	el	az	x1	y1	z1	x2	y2	z2
3.968	-2.2762	-52.0964	-212.8257	-0.445	-1.3075	-4.2686	-44.7039	-216.4771	-0.2839	-59.4888	-209.1743
3.984	-2.2372	-52.6344	-213.2924	-0.4587	-1.3135	-4.223	-45.0869	-217.1462	-0.2515	-60.1818	-209.4386
4	-1.8171	-52.5749	-213.4894	-0.5814	-1.384	-3.1052	-45.7617	-218.0465	-0.5291	-59.3882	-208.9323
4.016	-1.5779	-52.8933	-213.5551	-0.6058	-1.38	-2.9487	-45.7971	-218.5613	-0.2072	-59.9895	-208.5488
4.032	-1.364	-54.347	-212.5364	-0.6023	-1.3752	-2.688	-47.6658	-217.2196	-0.04	-61.0282	-207.8532
4.048	-1.3985	-52.3376	-214.0497	-0.6816	-1.3337	-2.5965	-47.3794	-218.1885	-0.2006	-57.2959	-209.911
4.064	-1.3164	-54.1179	-213.2777	-0.689	-1.3592	-2.6621	-47.8545	-218.5543	0.0293	-60.3812	-208.0011
4.08	-1.1903	-54.9248	-212.8253	-0.6648	-1.4231	-2.0856	-48.9091	-217.5924	-0.2951	-60.9406	-208.0582
4.096	-0.5461	-54.5043	-213.6436	-0.6413	-1.4739	-1.2285	-47.483	-218.9097	0.1363	-61.5256	-208.3775
4.112	-0.5045	-55.429	-213.6954	-0.588	-1.4923	-1.0642	-48.3113	-218.4554	0.0552	-62.5466	-208.9354
4.128	-0.4261	-56.792	-213.1933	-0.6008	-1.4937	-0.9818	-49.5943	-218.1405	0.1296	-63.9898	-208.2461
4.144	-0.3108	-56.3566	-213.733	-0.588	-1.5391	-0.4972	-50.4763	-217.6547	-0.1244	-62.2368	-209.8112
4.16	-0.1738	-54.9206	-214.633	-0.6341	-1.5685	-0.1895	-48.1642	-219.6022	-0.1581	-61.677	-209.6639
4.176	-0.0669	-54.219	-215.8844	-0.6645	-1.5767	-0.0282	-47.7122	-220.9813	-0.1056	-60.7258	-210.7874
4.192	0.0204	-55.2251	-215.6991	-0.5951	-1.5801	0.0885	-47.8988	-220.6584	-0.0478	-62.5514	-210.7397
4.208	-0.2916	-53.8704	-216.9429	-0.5995	-1.5847	-0.2056	-47.6846	-221.1707	-0.3776	-60.0561	-212.7151
4.224	-0.1897	-54.5813	-216.6728	-0.6572	-1.6206	0.1277	-48.2121	-221.5937	-0.5072	-60.9504	-211.752
4.24	-0.0313	-54.3678	-217.4202	-0.6419	-1.6598	0.5259	-48.1212	-222.1077	-0.5885	-60.6145	-212.7326
4.256	0.0729	-54.4822	-218.5152	-0.6639	-1.7148	0.9762	-47.2544	-223.4384	-0.8304	-59.7099	-213.5919
4.272	0.3233	-54.9168	-218.7556	-0.6864	-1.6618	0.8699	-48.9255	-223.6844	-0.2234	-60.9081	-213.8267
4.288	0.0877	-54.6529	-218.695	-0.6179	-1.7363	0.9555	-49.4566	-222.4394	-0.7801	-59.8492	-214.9505
4.304	0.3451	-55.7247	-218.9246	-0.6295	-1.7518	1.1797	-51.1645	-222.3014	-0.4896	-60.285	-215.5478
4.32	0.2787	-54.4643	-219.3726	-0.6892	-1.7709	1.2288	-49.7785	-223.3122	-0.6715	-59.15	-215.433
4.336	0.1875	-53.0005	-221.2994	-0.6371	-1.772	1.3186	-47.4539	-225.4889	-0.9435	-58.547	-217.11
4.352	0.4004	-54.5094	-220.3826	-0.6031	-1.7784	1.3883	-49.8204	-223.6826	-0.5874	-59.1985	-217.0827
4.368	0.184	-53.3342	-222.0316	-0.6037	-1.7534	1.053	-48.6285	-225.3314	-0.685	-58.04	-218.7318
4.384	0.0302	-52.4386	-223.0995	-0.5763	-1.7458	1.0841	-46.4795	-227.0327	-1.0237	-58.3978	-219.1662
4.4	0.3888	-53.3582	-222.4376	-0.636	-1.7331	1.279	-47.9219	-226.5047	-0.5013	-58.7945	-218.3705
4.416	0.1461	-53.1368	-223.6473	-0.6954	-1.7378	0.9259	-48.5105	-227.5622	-0.6337	-57.763	-219.7323
4.432	0.241	-53.6587	-223.9247	-0.5928	-1.7653	1.2074	-48.753	-227.2928	-0.7254	-58.5644	-220.5566
4.448	0.0958	-52.6091	-224.6566	-0.5588	-1.6814	0.7515	-46.7059	-228.3703	-0.5599	-58.5122	-220.9428
4.464	-0.115	-53.0271	-225.7035	-0.5242	-1.6498	0.4176	-46.3027	-229.6034	-0.6476	-59.7515	-221.8035
4.48	-0.3884	-53.065	-226.3375	-0.4712	-1.5828	-0.3059	-46.1931	-229.8391	-0.4708	-59.9369	-222.8359
4.496	-0.693	-52.5692	-226.7696	-0.4965	-1.4992	-1.2327	-45.0468	-230.8557	-0.1532	-60.0916	-222.6835
4.512	-0.4406	-51.3564	-227.833	-0.4859	-1.512	-0.9075	-43.4223	-232.0303	0.0263	-59.2905	-223.6357
4.528	-0.5262	-50.6771	-229.2288	-0.4675	-1.5122	-0.9251	-43.8714	-232.6702	-0.1272	-57.4828	-225.7874
4.544	-0.3638	-51.8505	-228.6904	-0.4079	-1.4969	-0.8559	-45.2012	-231.5715	0.1284	-58.4998	-225.8092
4.56	-0.6849	-49.6083	-230.9897	-0.406	-1.4601	-1.3444	-43.6733	-233.5566	-0.0253	-55.5433	-228.4228
4.576	-0.1993	-48.6668	-231.8514	-0.3639	-1.5101	-0.5966	-42.1327	-234.3447	0.1981	-55.2009	-229.358
4.592	-0.0199	-48.7383	-231.5629	-0.3397	-1.3705	-1.4068	-41.9071	-234.0264	1.3671	-55.5696	-229.0993
4.608	-0.5691	-48.7293	-232.227	-0.339	-1.4018	-1.8699	-41.1041	-234.9543	0.7317	-56.3545	-229.4998
4.624	-0.6081	-47.8612	-233.26	-0.3486	-1.372	-1.9354	-41.2719	-235.7026	0.7192	-54.4506	-230.8174
4.64	-1.1003	-48.6039	-233.0446	-0.2382	-1.4078	-2.2505	-41.6098	-234.7655	0.0498	-55.5981	-231.3237
4.656	-0.7583	-50.0816	-232.7161	-0.1415	-1.3504	-2.0868	-44.1509	-233.5818	0.5703	-56.0124	-231.8504
4.672	0.2775	-49.3999	-233.9624	-0.2003	-1.783	1.7588	-42.524	-235.3906	-1.2037	-56.2758	-232.5342
4.688	-0.6607	-49.0778	-234.7161	-0.3321	-1.7522	0.47	-42.9118	-236.878	-1.7914	-55.2437	-232.5543
4.704	-0.9314	-50.5994	-233.5948	-0.3753	-1.732	0.0659	-44.4651	-236.0431	-1.9287	-56.7338	-231.1466
4.72	-0.9712	-50.3487	-234.7692	-0.385	-1.8256	0.4149	-45.0262	-236.9979	-2.3572	-55.6712	-232.5405
4.736	-0.462	-49.5388	-235.15	-0.3744	-1.8648	1.1953	-44.0657	-237.3967	-2.1192	-55.0118	-232.9033
4.752	-1.3293	-49.032	-235.7663	-0.4135	-1.7795	0.0276	-42.6259	-238.6396	-2.6862	-55.4382	-232.893
4.768	-1.4364	-49.4322	-237.013	-0.4704	-1.8039	-0.0866	-43.7459	-239.9847	-2.7863	-55.1185	-234.0412
4.784	-1.3472	-49.5349	-237.3845	-0.5081	-1.814	-0.1329	-44.64	-240.1931	-2.5616	-54.4297	-234.5759
4.8	-1.3914	-49.5389	-238.1929	-0.5053	-1.8106	-0.162	-44.5112	-241.0563	-2.6208	-54.5666	-235.3296
4.816	-1.8512	-48.6058	-239.5741	-0.5624	-1.707	-1.0449	-42.723	-243.3164	-2.6574	-54.4886	-235.8318
4.832	-2.021	-48.7229	-240.361	-0.5784	-1.7897	-0.7297	-42.9188	-244.2429	-3.3124	-54.527	-236.4791
4.848	-2.5668	-48.0332	-239.9419	-0.4737	-1.8806	-1.2787	-44.0087	-242.108	-3.8548	-52.0576	-237.7758
4.864	-2.5206	-48.614	-239.3249	-0.3167	-1.6723	-1.9429	-42.9403	-241.1942	-3.0982	-52.2878	-237.4557
4.88	-2.7147	-47.8919	-240.013	-0.5076	-1.781	-1.666	-42.9771	-242.8084	-3.7634	-52.8067	-237.2176

Rockan9

time	pos(x)	pos(y)	pos(z)	el	az	x1	y1	z1	x2	y2	z2
0	0	0	0	0.0982	-1.649	0.2279	2.9074	0.2873	-0.2279	-2.9074	-0.2873
0.016	0.4021	2.0016	-1.729	0.2043	-1.9922	1.5445	4.5503	-1.1503	-0.7403	-0.5471	-2.3077
0.032	1.8604	4.2183	-4.4058	-0.2334	-2.2484	3.4438	6.1859	-5.0063	0.277	2.2507	-3.8054
0.048	2.3568	5.6976	-6.5664	-0.3973	-2.8052	5.7195	6.8733	-8.0612	-1.0059	4.5219	-5.0716

Rock9

time	pos(x)	pos(y)	pos(z)	el	az	x1	y1	z1	x2	y2	z2
0.064	3.3756	6.611	-7.851	-0.3695	-2.8067	7.4884	8.0422	-9.5378	-0.7371	5.1797	-6.1643
0.08	3.5522	7.5572	-8.6954	-0.5318	-3.0856	7.4037	7.7731	-10.9648	-0.2994	7.3414	-6.4261
0.096	4.5816	6.4835	-11.1721	-0.6351	-2.9765	8.3074	7.1042	-13.9558	0.8557	5.8629	-8.3883
0.112	5.6824	6.2742	-13.4485	-0.7982	2.9399	9.417	5.5106	-17.3593	1.9479	7.0377	-9.5377
0.128	7.6521	7.6606	-14.7065	-0.8208	2.7967	12.7612	5.8254	-20.534	2.543	9.4958	-8.879
0.144	8.1843	8.2248	-15.6828	-0.7625	2.731	13.4319	5.9406	-21.1494	2.9367	10.509	-10.2163
0.16	10.5148	8.669	-16.2124	-0.7686	2.7124	15.5569	6.3612	-21.5745	5.4727	10.9767	-10.8503
0.176	11.4685	9.84	-16.9786	-0.6722	2.8518	17.7925	7.9545	-22.2301	5.1445	11.7254	-11.7271
0.192	12.9651	9.6778	-18.2321	-0.7286	2.7504	17.5903	7.7699	-22.6969	8.3399	11.5856	-13.7674
0.208	14.1624	9.8703	-19.4274	-0.6606	2.8702	19.5515	8.371	-23.7742	8.7733	11.3696	-15.0807
0.224	16.1495	10.0433	-20.3839	-0.6467	2.9284	21.6169	8.8598	-24.6073	10.6821	11.2268	-16.1604
0.24	17.4559	9.6154	-22.6678	-0.4335	3.0475	23.3919	9.0555	-25.4273	11.52	10.1753	-19.9084
0.256	20.034	10.5961	-24.1348	-0.2484	2.9677	26.5577	9.4498	-25.815	13.5103	11.7424	-22.4545
0.272	21.1773	10.4676	-24.7761	-0.2331	2.9563	27.5095	9.2809	-26.3054	14.8452	11.6542	-23.2468
0.288	21.356	8.6782	-26.858	-0.1535	2.9948	28.9789	7.5512	-28.0505	13.733	9.8051	-25.6656
0.304	24.6858	9.9777	-26.8276	-0.224	2.9499	30.5678	8.8364	-28.1925	18.8039	11.119	-25.4627
0.32	25.7076	10.3661	-28.0028	0.051	3.0219	33.2407	9.4603	-27.6156	18.1745	11.2719	-28.39
0.336	27.1961	10.9903	-27.4999	0.1141	3.0581	35.0008	10.3372	-26.602	19.3914	11.6435	-28.3977
0.352	27.702	11.5172	-27.6503	0.1103	3.0632	35.541	10.9012	-26.7797	19.8629	12.1332	-28.5209
0.368	29.798	12.1756	-28.1817	0.2872	3.0717	36.9703	11.6736	-26.0578	22.6257	12.6776	-30.3055
0.384	29.9263	12.3443	-28.1851	0.3582	3.0644	37.755	11.7389	-25.2461	22.0975	12.9496	-31.124
0.4	30.307	12.5216	-28.3584	0.5412	3.1375	37.5115	12.4923	-24.0275	23.1025	12.5509	-32.6892
0.416	31.451	13.1555	-27.9161	0.6067	3.0823	38.1035	12.7605	-23.2915	24.7985	13.5505	-32.5408
0.432	32.9671	13.1337	-28.2476	0.7351	-3.1353	38.7634	13.1701	-23.0065	27.1709	13.0974	-33.4888
0.448	32.837	13.8003	-28.0863	0.7455	3.0844	38.7902	13.4594	-22.5808	26.8837	14.1413	-33.5918
0.464	33.5118	13.9946	-28.822	0.6586	2.9738	39.5073	12.9788	-24.1165	27.5164	15.0104	-33.5276
0.48	34.4824	13.9909	-28.995	0.8064	3.0197	39.8589	13.3321	-23.3457	29.1058	14.6496	-34.6443
0.496	36.3269	14.1288	-29.9235	0.8336	3.093	41.8902	13.8584	-23.7888	30.7637	14.3992	-36.0581
0.512	36.5877	14.8223	-30.061	0.9082	2.9882	41.4033	14.0779	-23.8157	31.7721	15.5667	-36.3063
0.528	37.4624	15.0228	-30.4703	0.9022	3.0249	42.4253	14.441	-24.1449	32.4996	15.6045	-36.7957
0.544	36.9811	15.4337	-30.8172	0.999	2.8345	40.766	14.2336	-24.6463	33.1962	16.6338	-36.9881
0.56	36.8524	16.1711	-30.7823	1.0252	2.8511	40.3394	15.1285	-24.7871	33.3654	17.2137	-36.7774
0.576	38.0145	15.6242	-31.5046	1.0208	2.9094	41.8395	14.7196	-25.0933	34.1895	16.5287	-37.9159
0.592	38.9074	15.3511	-32.4717	1.0364	2.8617	42.5374	14.3076	-26.0904	35.2774	16.3945	-38.8531
0.608	38.3061	16.3816	-33.1705	0.9977	2.8601	42.5697	15.1489	-26.2925	34.0424	17.6143	-40.0485
0.624	38.7236	16.5636	-33.3635	0.9693	2.964	43.0668	15.7839	-26.9338	34.3805	17.3433	-39.7933
0.64	38.5742	16.8715	-33.7527	0.8443	2.8694	43.4382	15.5139	-28.0695	33.7101	18.229	-39.4358
0.656	40.1351	17.1538	-34.9105	0.9516	2.9482	44.4845	16.3021	-28.6917	35.7858	18.0055	-41.1293
0.672	39.9732	17.4207	-35.7809	0.9017	2.8925	44.4096	16.2922	-29.9922	35.5367	18.5492	-41.5696
0.688	40.3421	17.9235	-36.2526	0.951	3.0133	44.8653	17.34	-29.8608	35.8189	18.507	-42.6443
0.704	39.6828	17.2143	-37.5119	0.905	2.9031	44.0431	16.1542	-31.7986	35.3224	18.2743	-43.2252
0.72	39.7498	17.3648	-39.108	0.9502	2.8745	43.8716	16.2369	-33.1302	35.6279	18.4927	-45.0859
0.736	39.7159	17.0751	-40.7736	0.9256	2.958	44.3519	16.2141	-34.5084	35.08	17.9361	-47.0387
0.752	39.7161	17.3999	-41.616	0.8726	2.9458	44.5118	16.4489	-35.7906	34.9204	18.3508	-47.4414
0.768	39.2565	17.4846	-42.978	0.9642	3.0082	43.4552	16.9212	-36.8727	35.0577	18.048	-49.0833
0.784	38.4842	18.4504	-43.7555	0.9339	2.9207	42.6067	17.5246	-38.0438	34.3618	19.3762	-49.4672
0.8	39.1615	18.5779	-44.6775	0.9356	2.9043	43.3552	17.5637	-38.824	34.9677	19.592	-50.531
0.816	38.6614	18.9843	-46.0012	0.9798	3.0228	42.6967	18.5028	-39.9443	34.6262	19.4657	-52.0581
0.832	37.8647	18.303	-48.6035	0.8753	3.0403	42.6714	17.8143	-42.8144	33.0579	18.7917	-54.3925
0.848	37.6759	19.2073	-49.706	0.8944	2.9716	42.5312	18.3739	-43.5691	32.8207	20.0407	-55.8429
0.864	37.8584	18.512	-51.3601	0.8813	3.0781	42.7741	18.1996	-45.3855	32.9427	18.8245	-57.3348
0.88	36.8871	19.2744	-52.1155	0.7413	3.0486	43.1301	18.692	-46.3752	30.644	19.8569	-57.8559
0.896	37.1806	19.0508	-54.0073	0.7595	3.0891	43.2226	18.7332	-48.2627	31.1387	19.3685	-59.7519
0.912	37.5525	19.089	-55.9202	0.7772	-3.0721	43.8645	19.5284	-49.6956	31.2405	18.6496	-62.1449
0.928	36.4042	18.9551	-57.5183	0.6726	3.1328	42.853	18.8981	-52.3816	29.9553	19.0121	-62.6551
0.944	35.1345	19.0301	-58.6902	0.5581	-3.1083	42.3362	19.2699	-54.1918	27.9329	18.7902	-63.1887
0.96	35.6826	18.8063	-60.3224	0.5835	-3.036	43.3511	19.6188	-55.2312	28.0141	17.9939	-65.4136
0.976	35.5538	18.6768	-61.5209	0.5763	-3.0077	43.2709	19.7162	-56.4606	27.8366	17.6374	-66.5813
0.992	33.3442	18.8832	-62.8244	0.5632	-2.9658	42.2646	20.4677	-57.1032	24.4238	17.2987	-68.5456
1.008	31.9085	18.7454	-64.2865	0.4809	-3.0395	40.5889	19.6343	-59.7335	23.228	17.8565	-68.8395
1.024	30.1919	18.1167	-66.6444	0.3748	-2.9875	39.8207	19.6127	-62.8106	20.563	16.6206	-70.4781
1.04	31.0973	17.0162	-68.2549	0.3762	-3.0185	40.7703	18.2128	-64.4046	21.4243	15.8197	-72.1053
1.056	28.9843	17.1588	-69.4469	0.3091	-3.0862	38.8356	17.7048	-66.2957	19.133	16.6127	-72.5981
1.072	28.0828	16.8678	-70.3221	0.3129	-3.0015	37.9441	18.2587	-67.0998	18.2214	15.477	-73.5444
1.088	27.128	16.1865	-71.1097	0.194	-3.0011	37.6506	17.6749	-69.0214	16.6053	14.698	-73.1979
1.104	25.1075	15.9721	-72.2281	0.2172	-2.973	35.4968	17.74	-69.9025	14.7183	14.2043	-74.5537

Rock9

time	pos(x)	pos(y)	pos(z)	el	az	x1	y1	z1	x2	y2	z2
1.12	26.1019	15.374	-72.9184	0.2119	-3.0844	36.0014	15.9407	-70.7848	16.2023	14.8073	-75.052
1.136	24.5741	15.8714	-73.1743	0.0209	-3.1304	34.8618	15.9863	-72.9588	14.2864	15.7564	-73.3899
1.152	25.8052	15.2343	-74.116	0.0349	3.1101	34.514	14.9597	-73.8116	17.0964	15.5088	-74.4204
1.168	21.1841	16.4479	-73.4641	-0.0833	3.0703	31.6789	15.6982	-74.3431	10.6892	17.1975	-72.5851
1.184	22.1795	14.1478	-75.0866	-0.1091	3.0924	30.1208	13.7572	-75.9577	14.2381	14.5384	-74.2154
1.2	21.7794	14.4681	-74.6762	-0.115	3.0108	30.9935	13.2558	-75.7497	12.5654	15.6804	-73.6028
1.216	22.2762	14.3615	-75.9216	-0.1236	3.0258	30.8916	13.3596	-76.9989	13.6609	15.3635	-74.8443
1.232	19.0198	14.5237	-75.937	-0.1656	3.0793	28.1936	13.9519	-77.4737	9.8459	15.0954	-74.4004
1.248	18.9176	14.4522	-77.0452	-0.182	3.0975	28.0884	14.048	-78.735	9.7467	14.8564	-75.3555
1.264	16.9559	13.6312	-77.3957	-0.2285	3.0314	25.7065	12.6628	-79.443	8.2052	14.5996	-75.3483
1.28	17.1658	13.7742	-77.5708	-0.2029	3.079	25.4017	13.2582	-79.2681	8.9299	14.2903	-75.8735
1.296	15.174	13.995	-77.2995	-0.2348	3.1198	23.5982	13.8117	-79.315	6.7497	14.1783	-75.2839
1.312	15.9086	13.8855	-77.6664	-0.2591	3.1024	23.9257	13.5716	-79.7926	7.8916	14.1995	-75.5401
1.328	15.3933	13.7734	-77.5917	-0.2591	3.1205	23.1141	13.6105	-79.6384	7.6725	13.9364	-75.545
1.344	14.555	13.7575	-78.1626	-0.3441	3.1392	22.3651	13.7386	-80.9611	6.7449	13.7763	-75.3641
1.36	13.024	13.332	-78.4439	-0.3818	3.1388	20.9391	13.3099	-81.6216	5.1088	13.3541	-75.2662
1.376	13.4647	13.4529	-79.0905	-0.4041	-3.1358	20.6868	13.4946	-82.1788	6.2425	13.4113	-76.0023
1.392	13.0439	13.5775	-78.7686	-0.4274	3.1308	21.2806	13.4889	-82.5208	4.8073	13.6662	-75.0164
1.408	12.6069	14.1838	-79.5884	-0.5413	-3.1073	19.6087	14.4241	-83.8001	5.6052	13.9435	-75.3768
1.424	12.7932	14.5181	-79.9221	-0.5201	-3.0382	19.7308	15.2379	-83.9165	5.8555	13.7984	-75.9277
1.44	12.9955	14.7214	-80.7169	-0.6025	-3.0713	19.049	15.1474	-84.8912	6.9419	14.2955	-76.5425
1.456	12.5969	14.8805	-81.024	-0.6929	-3.0782	18.8001	15.2743	-86.1841	6.3937	14.4867	-75.8639
1.472	11.4819	14.7155	-81.1803	-0.7294	-3.0687	17.4925	15.1547	-86.5675	5.4713	14.2763	-75.7931
1.488	11.3925	14.6932	-81.5136	-0.6907	-3.0615	17.788	15.2063	-86.8162	4.9969	14.1801	-76.211
1.504	12.5566	14.6441	-82.3625	-0.7437	-2.988	17.9128	15.4733	-87.348	7.2004	13.8148	-77.3769
1.52	12.3144	15.1402	-82.7276	-0.7404	-2.9754	17.7991	16.0604	-87.8096	6.8298	14.2199	-77.6456
1.536	11.7397	15.4266	-83.1345	-0.7253	-2.9084	17.445	16.7817	-88.3332	6.0343	14.0715	-77.9357
1.552	12.3716	15.656	-83.7622	-0.7181	-2.8788	17.8018	17.1166	-88.6755	6.9414	14.1955	-78.8488
1.568	13.0245	15.9214	-84.7423	-0.6913	-2.8773	19.1111	17.5685	-89.9606	6.9379	14.2743	-79.5239
1.584	13.5095	16.4338	-85.1081	-0.6917	-2.8075	19.0159	18.3448	-89.9347	8.0032	14.5228	-80.2814
1.6	13.7996	16.2835	-86.0921	-0.6472	-2.8158	20.0752	18.4038	-91.0986	7.5241	14.1633	-81.0856
1.616	14.1211	16.6696	-87.0378	-0.5669	-2.8085	21.3957	19.1865	-91.9378	6.8465	14.1526	-82.1378
1.632	14.4747	17.0064	-87.4775	-0.5777	-2.7771	21.4948	19.6852	-92.3752	7.4547	14.3276	-82.5798
1.648	14.3602	16.999	-88.2849	-0.5195	-2.7862	21.7401	19.7384	-92.7865	6.9803	14.2597	-83.7833
1.664	14.3046	17.021	-89.0364	-0.4758	-2.755	21.5662	19.9769	-93.0766	7.043	14.0651	-84.9962
1.68	14.2879	17.774	-89.6946	-0.3932	-2.7062	22.3055	21.5032	-93.3628	6.2702	14.0448	-86.0265
1.696	14.3623	18.4051	-90.5896	-0.3399	-2.7764	22.6831	21.5864	-93.7395	6.0415	15.2238	-87.4398
1.712	13.2207	18.0577	-90.8818	-0.343	-2.8973	22.6476	20.4073	-94.3512	3.7938	15.7081	-87.4125
1.728	13.5308	18.7985	-91.5348	-0.3106	-2.9463	23.2662	20.7238	-94.7199	3.7954	16.8731	-88.3496
1.744	14.9872	18.9357	-92.625	-0.3096	-2.8491	23.6545	21.5458	-95.5208	6.3198	16.3255	-89.7292
1.76	15.2216	18.9289	-93.0022	-0.3294	-2.8743	24.0157	21.3374	-96.1192	6.4275	16.5204	-89.8851
1.776	16.4416	19.569	-94.7729	-0.2555	-2.9245	25.3802	21.5406	-97.1636	7.5031	17.5975	-92.3822
1.792	16.2869	20.3314	-95.4487	-0.1592	-3.0564	25.7253	21.1378	-96.9698	6.8484	19.5249	-93.9277
1.808	17.5083	18.6361	-96.4517	-0.2045	3.0717	28.7048	17.8518	-98.7797	6.3118	19.4204	-94.1237
1.824	18.0957	18.7152	-97.2266	-0.1723	3.1032	27.9066	18.3382	-98.9348	8.2848	19.0921	-95.5183
1.84	19.0209	18.9207	-97.6689	-0.1165	3.0387	27.7594	18.018	-98.6971	10.2823	19.8233	-96.6407
1.856	18.8921	19.879	-98.4158	-0.0914	2.9495	30.1447	17.6906	-99.4666	7.6394	22.0674	-97.365
1.872	18.4046	20.8794	-99.1283	-0.0844	2.9991	29.3201	19.3135	-100.0618	7.4891	22.4454	-98.1949
1.888	18.8267	21.1704	-99.7732	-0.0243	2.9664	28.8453	19.3974	-100.0208	8.808	22.9433	-99.5255
1.904	19.8637	21.4531	-100.9522	0.0144	2.9255	30.7516	19.0635	-100.7911	8.9759	23.8427	-101.1132
1.92	19.1705	21.7084	-100.8847	0.0679	2.9343	29.2273	19.5937	-100.1858	9.1136	23.8231	-101.5836
1.936	20.2856	22.4069	-102.079	0.052	2.9664	31.1173	20.4897	-101.5066	9.4538	24.3242	-102.6514
1.952	19.1511	21.6042	-102.8754	0.1167	2.9903	28.3173	20.2064	-101.788	9.9849	23.0019	-103.9629
1.968	20.2152	22.0279	-103.391	0.1301	2.9629	30.8624	20.1053	-101.9757	9.568	23.9504	-104.8064
1.984	20.8131	21.4537	-104.7892	0.184	2.9268	30.3628	19.3706	-102.9697	11.2634	23.5368	-106.6087
2	21.0607	21.5025	-105.8567	0.1985	2.9703	30.9157	19.7974	-103.8453	11.2056	23.2076	-107.868
2.016	21.5574	22.2232	-106.6177	0.2353	2.9884	32.1356	20.5901	-104.0512	10.9793	23.8564	-109.1842
2.032	21.3888	22.2864	-107.5306	0.2351	2.9238	30.4859	20.2734	-105.2985	12.2917	24.2993	-109.7628
2.048	21.312	22.2544	-107.9217	0.1843	2.9967	30.8425	20.864	-106.1261	11.7814	23.6448	-109.7172
2.064	21.2932	22.8971	-108.6581	0.2513	2.9311	30.157	21.0038	-106.3314	12.4295	24.7905	-110.9848
2.08	20.5725	22.5609	-109.3801	0.2618	2.9471	29.9048	20.7228	-106.831	11.2402	24.399	-111.9291
2.096	21.2547	22.9147	-109.9483	0.2595	2.9371	30.4165	21.015	-107.4641	12.0929	24.8143	-112.4326
2.112	22.1508	22.6395	-110.7823	0.2786	2.9401	30.6651	20.9002	-108.2967	13.6366	24.3788	-113.268
2.128	21.6862	23.5684	-111.6167	0.2301	2.9266	30.2443	21.6992	-109.5651	13.1281	25.4376	-113.6684
2.144	22.6404	23.2635	-112.8345	0.2131	2.9303	31.4644	21.3707	-110.8813	13.8164	25.1562	-114.7878
2.16	23.0395	23.7881	-112.7392	0.2583	2.9025	30.616	21.9411	-110.6786	15.4631	25.6351	-114.7999

Rock9

time	pos(x)	pos(y)	pos(z)	el	az	x1	y1	z1	x2	y2	z2
2.176	22.8878	23.128	-113.7481	0.2677	2.9147	31.1839	21.2131	-111.4125	14.5916	25.0429	-116.0836
2.192	21.5135	23.6055	-114.51	0.2294	2.9421	30.4374	21.8013	-112.3841	12.5897	25.4098	-116.6358
2.208	22.6272	24.0505	-115.4706	0.1924	2.9428	31.8383	22.1948	-113.6406	13.4161	25.9061	-117.3007
2.224	22.648	24.3404	-115.8539	0.2173	2.9213	31.9095	22.2668	-113.758	13.3865	26.4139	-117.9498
2.24	21.3039	24.8328	-116.9132	0.1528	2.957	31.2409	22.9777	-115.356	11.3669	26.6879	-118.4705
2.256	22.503	23.9988	-117.6044	0.1164	2.9656	32.0995	22.2923	-116.4645	12.9066	25.7053	-118.7444
2.272	22.9628	23.228	-118.1114	0.1195	2.9547	32.4046	21.4424	-116.9579	13.5209	25.0137	-119.2649
2.288	21.8404	24.6897	-118.7443	0.036	2.9287	32.39	22.4088	-118.355	11.2909	26.9706	-119.1335
2.304	21.9751	24.7767	-119.4278	-0.0052	2.9238	32.4106	22.4672	-119.4831	11.5396	27.0863	-119.3725
2.32	22.468	24.6765	-119.9228	-0.0256	2.9433	32.8909	22.5825	-120.1947	12.0452	26.7705	-119.651
2.336	22.0083	24.5934	-120.5451	-0.0303	2.9692	33.1863	22.6471	-120.8887	10.8303	26.5398	-120.2015
2.352	23.1212	25.0429	-121.7359	-0.0463	2.9392	33.9317	22.8243	-122.2475	12.3107	27.2615	-121.2243
2.368	22.5913	25.223	-121.5249	-0.0759	2.8831	33.0944	22.4455	-122.3512	12.0882	28.0004	-120.6987
2.384	22.08	25.7169	-122.0642	-0.0516	2.9029	32.7755	23.1145	-122.6332	11.3844	28.3194	-120.4952
2.4	21.3162	26.0784	-122.1602	-0.0554	2.8722	32.5203	22.9853	-122.8051	10.1122	29.1715	-121.5154
2.416	21.9206	26.253	-123.4129	-0.1074	2.8507	31.5769	23.3618	-124.4998	12.2642	29.1442	-122.3261
2.432	23.0781	26.1273	-124.5143	-0.0965	2.879	32.8784	23.4931	-125.4964	13.2778	28.7615	-123.5322
2.448	22.3783	26.5407	-124.6181	-0.1196	2.947	32.8176	24.4829	-125.8965	11.9391	28.5986	-123.3397
2.464	22.4277	27.857	-125.1449	-0.1181	2.8828	32.6823	25.1422	-126.4035	12.1731	30.5718	-123.8863
2.48	23.5419	25.448	-126.6245	-0.1097	2.89	32.8762	23.0485	-127.6862	14.2075	27.8476	-125.5627
2.496	23.6412	25.9352	-127.7761	-0.1223	2.9032	32.7941	23.7111	-128.9342	14.4883	28.1594	-126.618
2.512	24.0601	26.1208	-128.4819	-0.0875	2.8787	33.3248	23.627	-129.3236	14.7953	28.6145	-127.6403
2.528	23.1002	27.508	-128.8132	-0.1269	2.8896	32.0876	25.194	-129.9976	14.1129	29.822	-127.6289
2.544	22.5155	27.3958	-129.1427	-0.0705	2.9053	32.257	25.0502	-129.8505	12.774	29.7414	-128.4348
2.56	24.6376	27.1528	-130.0383	-0.1349	2.9281	33.3096	25.2726	-131.243	15.9655	29.0331	-128.8336
2.576	22.4415	26.7823	-130.6047	-0.0616	2.8811	33.2259	23.9074	-131.2928	11.6571	29.6571	-129.9165
2.592	23.3438	27.2718	-131.2824	-0.0829	2.8806	33.8825	24.4572	-132.1886	12.805	30.0864	-130.3763
2.608	22.6961	27.793	-131.7574	-0.0846	2.9349	33.1645	25.5979	-132.6648	12.2277	29.988	-130.85
2.624	23.0815	27.9676	-132.1315	-0.071	2.917	34.1688	25.4342	-132.9402	11.9942	30.5009	-131.3229
2.64	23.6164	27.6507	-133.4205	-0.0578	2.87	34.2139	24.6999	-134.0566	13.0189	30.6015	-132.7844
2.656	23.3706	28.0957	-134.0812	-0.0623	2.8989	32.9167	25.732	-134.6942	13.8246	30.4594	-133.4682
2.672	23.1625	27.9322	-134.9778	-0.0643	2.9062	33.106	25.5479	-135.6361	13.219	30.3165	-134.3195
2.688	23.2453	28.6147	-136.3052	-0.1764	2.9622	34.8161	26.5166	-138.4008	11.6745	30.7128	-134.2096
2.704	22.8702	29.0124	-137.7716	-0.1471	2.9481	33.5516	26.9195	-139.3841	12.1887	31.1053	-136.1591
2.72	23.875	28.7281	-138.4074	-0.1628	2.9613	35.3041	26.6454	-140.3155	12.4458	30.8109	-136.4994
2.736	23.3349	28.8834	-139.3718	-0.1608	2.9534	35.0314	26.6552	-141.3036	11.6383	31.1115	-137.4401
2.752	23.9697	28.6641	-140.4961	-0.168	2.9619	35.2677	26.6119	-142.4438	12.6716	30.7162	-138.5484
2.768	24.1944	29.3116	-141.1688	-0.1841	2.9576	35.9403	27.1255	-143.3942	12.4484	31.4977	-138.9435
2.784	23.7649	28.9177	-142.7051	-0.2112	2.9764	34.6113	27.1099	-145.0632	12.9185	30.7254	-140.3471
2.8	24.4335	28.7335	-142.8845	-0.2245	2.9851	34.8696	27.0864	-145.2967	13.9974	30.3805	-140.4724
2.816	25.9237	29.2631	-145.2374	-0.1376	2.9455	36.2222	27.2175	-146.6918	15.6251	31.3087	-143.7829
2.832	25.7681	29.1052	-145.6712	-0.1714	2.9453	36.4362	26.9838	-147.5537	15.1	31.2266	-143.7887
2.848	26.7559	29.1235	-146.4106	-0.1744	2.9598	37.3041	27.184	-148.3004	16.2077	31.063	-144.5208
2.864	26.6649	28.9591	-147.2409	-0.1668	2.9677	37.4973	27.0564	-149.0925	15.8325	30.8618	-145.3893
2.88	26.8732	29.1383	-148.1535	-0.1672	2.9522	37.2917	27.1415	-149.9443	16.4547	31.1352	-146.3627
2.896	26.6383	29.1705	-149.6619	-0.1543	2.9555	37.0814	27.2044	-151.3149	16.1951	31.1366	-148.0089
2.912	26.8271	29.3758	-150.8474	-0.1605	2.9756	37.7181	27.5508	-152.6348	15.9361	31.2008	-149.06
2.928	28.241	29.1049	-152.2423	-0.0926	2.9414	38.6332	26.9963	-153.2274	17.8488	31.2134	-151.2573
2.944	27.7723	30.7006	-153.4653	-0.0998	3.0582	40.0547	29.6734	-154.6996	15.4899	31.7278	-152.2309
2.96	27.9305	30.732	-154.7674	-0.0949	3.0358	38.2274	29.6381	-155.753	17.6335	31.826	-153.7817
2.976	29.3194	30.1221	-154.9332	-0.129	3.0736	40.3065	29.3739	-156.3614	18.3322	30.8704	-153.5051
2.992	30.0596	30.7338	-156.6907	-0.1516	3.1037	40.0543	30.3552	-158.2184	20.0649	31.1124	-155.163
3.008	30.9077	30.3012	-157.2901	-0.1485	3.112	41.8651	29.9765	-158.93	19.9502	30.6259	-155.6502
3.024	29.6968	30.3671	-158.273	-0.16	-3.1398	40.8795	30.3877	-160.0777	18.514	30.3465	-156.4683
3.04	30.7537	30.3715	-158.6153	-0.1847	-3.1098	42.4805	30.7448	-160.8071	19.027	29.9982	-156.4236
3.056	32.7752	31.4754	-160.3667	-0.0486	-3.0195	44.3688	32.8976	-160.9346	21.1816	30.0532	-159.7988
3.072	31.5061	31.2687	-160.9455	-0.0847	-3.1007	43.6997	31.7785	-162.005	19.0425	30.759	-159.8861
3.088	32.6277	30.8919	-161.7466	-0.0486	-3.0176	44.1822	32.3322	-162.3133	21.0732	29.4517	-161.1799
3.104	33.2851	31.4663	-162.2362	0.043	-2.9111	45.9761	34.4443	-161.6753	20.5942	28.4884	-162.797
3.12	31.7626	31.9162	-163.4375	0.0717	-2.8003	43.0381	35.9214	-162.5781	20.4872	27.911	-164.2969
3.136	33.4113	32.3744	-164.5535	0.063	-2.8075	44.8958	36.3607	-163.7868	21.9267	28.3881	-165.3203
3.152	32.0639	31.9558	-164.9666	0.0498	-2.8187	43.8897	35.9131	-164.3447	20.2381	27.9984	-165.5874
3.168	33.6052	30.1864	-166.5852	0.205	-2.3496	39.8069	36.471	-164.7493	27.4035	23.9018	-168.421
3.184	33.6062	30.0599	-168.019	0.1379	-2.3064	39.9992	37.124	-166.6966	27.2133	22.9958	-169.3415
3.2	32.8613	31.0733	-168.9275	0.1083	-2.5644	42.3229	37.234	-167.7004	23.3998	24.9126	-170.1545
3.216	34.4164	30.7013	-170.1366	0.081	-2.5402	43.384	36.8549	-169.2541	25.4488	24.5477	-171.0192

Rock9

time	pos(x)	pos(y)	pos(z)	el	az	x1	y1	z1	x2	y2	z2
3.232	34.063	31.5259	-169.7949	0.1749	-2.414	41.5064	38.1549	-168.034	26.6196	24.8969	-171.5559
3.248	36.2878	31.2228	-171.0708	0.2108	-2.4836	44.9911	37.949	-168.7168	27.5846	24.4966	-173.4247
3.264	34.5517	31.1758	-172.6212	0.1338	-2.4125	42.7499	38.499	-171.142	26.3536	23.8527	-174.1005
3.28	35.0724	31.2181	-172.6429	0.1534	-2.2795	41.778	39.0393	-171.05	28.3669	23.3969	-174.2358
3.296	36.3402	31.8787	-174.2133	0.174	-2.3317	42.8263	38.6908	-172.5601	29.854	25.0665	-175.8664
3.312	35.7614	31.9333	-174.9171	0.1526	-2.279	41.6989	38.8659	-173.513	29.824	25.0007	-176.3212
3.328	34.5828	31.8647	-175.9142	0.1228	-2.1539	39.4621	39.2624	-174.8206	29.7036	24.4671	-177.0078
3.344	36.7248	31.2989	-176.5632	0.1588	-2.2968	42.5898	37.9058	-175.1488	30.8598	24.692	-177.9777
3.36	37.4256	31.7424	-177.828	0.2472	-2.3788	43.7368	37.7746	-175.6252	31.1144	25.7103	-180.0308
3.376	37.2864	31.5646	-178.3157	0.1858	-2.1405	41.5218	38.1769	-176.8393	33.0511	24.9522	-179.7921
3.392	34.7063	32.262	-178.229	0.1743	-2.1805	39.411	38.997	-176.7824	30.0016	25.5271	-179.6755
3.408	35.8617	32.5257	-179.5809	0.2294	-2.0572	39.5733	39.5451	-177.7266	32.1501	25.5062	-181.4352
3.424	35.5838	31.7991	-181.6568	0.1163	-1.917	38.2964	39.3181	-180.723	32.8713	24.2801	-182.5906
3.44	36.0685	31.4288	-181.8597	0.0716	-2.0019	39.1314	38.0884	-181.3338	33.0057	24.7692	-182.3856
3.456	33.6997	31.3135	-182.2139	0.1129	-1.6709	34.3435	37.7203	-181.4835	33.0558	24.9067	-182.9443
3.472	34.2243	31.4862	-183.7739	0.0944	-1.436	33.3038	38.2712	-183.1256	35.1448	24.7012	-184.4222
3.488	35.238	31.1142	-184.2746	0.0368	-1.4639	34.4742	38.2344	-184.0111	36.0018	23.9939	-184.5381
3.504	34.2434	31.284	-185.2865	0.1002	-1.5605	34.1833	37.093	-184.7023	34.3034	25.475	-185.8707
3.52	34.6299	30.8314	-186.3182	0.0215	-1.2016	32.687	35.8526	-186.2023	36.5729	25.8102	-186.434
3.536	36.2396	30.4835	-187.1404	-0.0452	-1.3027	34.8915	35.3919	-187.3705	37.5878	25.5751	-186.9104
3.552	36.894	30.7144	-187.8013	-0.0343	-1.3876	36.036	35.3445	-187.9629	37.752	26.0843	-187.6398
3.568	39.1054	30.6738	-188.7521	-0.06	-1.109	37.0467	34.8101	-189.0296	41.1642	26.5375	-188.4746
3.584	38.1571	31.0877	-189.5525	0.0076	-1.2853	37.0564	34.8378	-189.5228	39.2578	27.3376	-189.5822
3.6	38.7598	31.2532	-191.3558	-0.0405	-1.2567	37.3206	35.6836	-191.5447	40.199	26.8229	-191.1668
3.616	37.7513	31.6414	-191.0623	0.0037	-1.2272	36.2209	35.9189	-191.0454	39.2817	27.3639	-191.0792
3.632	38.4009	31.8525	-191.7829	-0.1325	-1.3767	37.5187	36.3402	-192.3925	39.2831	27.3648	-191.1733
3.648	39.0761	32.3258	-192.8288	-0.0127	-1.017	36.4308	36.6036	-192.8928	41.7214	28.0481	-192.7648
3.664	39.8102	32.7833	-193.9153	0.0169	-0.7653	36.3089	36.1466	-193.8331	43.3115	29.4201	-193.9975
3.68	39.7318	32.5653	-195.0723	-0.0455	-0.8966	36.4669	36.6509	-195.3105	42.9966	28.4798	-194.8341
3.696	41.0066	32.8794	-196.3178	0.0075	-0.8002	37.5786	36.4104	-196.2809	44.4346	29.3485	-196.3547
3.712	40.0888	33.6065	-196.3519	0.1871	-0.5562	35.2779	36.5971	-195.2797	44.8996	30.616	-197.4242
3.728	38.5651	34.3952	-197.1026	0.0348	-0.6406	33.3826	38.2585	-196.8776	43.7476	30.532	-197.3275
3.744	40.5096	33.0884	-197.7807	-0.183	-0.4899	35.15	35.9465	-198.9049	45.8693	30.2303	-196.6565
3.76	38.5603	34.069	-197.8912	-0.2196	-0.4751	34.0959	36.3655	-199.0118	43.0247	31.7725	-196.7706
3.776	41.6589	32.908	-199.4288	-0.2375	-0.4185	36.2176	35.3284	-200.8707	47.1003	30.4877	-197.9869
3.792	43.2772	32.529	-200.1585	-0.2053	-0.3113	38.1663	34.1733	-201.2764	48.3881	30.8847	-199.0405
3.808	39.1077	33.7801	-201.1498	-0.08	-0.2178	32.651	35.2089	-201.68	45.5643	32.3512	-200.6196
3.824	39.5868	33.4168	-201.7094	-0.0059	-0.1609	32.4849	34.5693	-201.7517	46.6887	32.2644	-201.6671
3.84	38.6237	33.9121	-203.897	0.079	-0.1996	31.5347	35.346	-203.3242	45.7127	32.4781	-204.4698
3.856	34.9206	35.0059	-203.4706	-0.0815	-0.1134	29.2968	35.6463	-203.9332	40.5445	34.3654	-203.008
3.872	37.8952	35.1182	-205.0827	-0.1181	-0.1052	32.8248	35.6534	-205.6878	42.9657	34.5831	-204.4775
3.888	39.3968	34.3444	-205.0392	-0.0157	-0.0476	31.4304	34.7238	-205.1646	47.3632	33.965	-204.9138
3.904	38.5319	35.153	-206.7889	-0.0138	-0.0645	32.8345	35.521	-206.8677	44.2293	34.785	-206.7102
3.92	38.5773	35.1758	-207.6202	-0.1484	0.0073	33.9445	35.1419	-208.3129	43.2101	35.2098	-206.9275
3.936	41.3159	34.5964	-208.5015	-0.1605	-0.0037	36.138	34.6157	-209.3396	46.4939	34.577	-207.6633
3.952	40.93	35.1215	-209.3078	-0.1844	0.0762	35.016	34.67	-210.4139	46.8441	35.573	-208.2016
3.968	42.574	34.7044	-210.1517	-0.16	0.2585	38.1386	33.5317	-210.8924	47.0095	35.8771	-209.4111
3.984	43.214	34.8363	-210.977	-0.1844	0.2578	38.1501	33.5013	-211.9538	48.2779	36.1712	-210.0002
4	41.2166	35.8762	-211.7426	-0.3021	0.0767	34.0929	35.3289	-213.9695	48.3404	36.4234	-209.5157
4.016	38.5024	36.5159	-212.4842	-0.1904	0.0922	30.669	35.7915	-214.0001	46.3358	37.2404	-210.9683
4.032	39.6384	36.2953	-213.4419	-0.1647	0.1054	31.7802	35.4637	-214.7554	47.4966	37.1269	-212.1284
4.048	39.2256	36.7843	-214.7177	-0.2542	0.1049	33.1856	36.1483	-216.2954	45.2657	37.4203	-213.14
4.064	39.8283	36.7261	-215.4547	-0.1977	0.2022	35.4365	35.8259	-216.3525	44.2201	37.6264	-214.5569
4.08	41.4581	36.384	-215.454	-0.1893	0.076	34.2578	35.8355	-216.8372	48.6585	36.9324	-214.0707
4.096	42.743	36.551	-216.6952	-0.1802	0.1023	35.4919	35.807	-218.0231	49.9942	37.295	-215.3673
4.112	41.0468	36.6513	-217.6753	-0.2887	0.23	34.112	35.0277	-219.7905	47.9816	38.275	-215.5601
4.128	41.2417	37.2607	-218.6998	-0.2112	0.0318	32.3236	36.9769	-220.6124	50.1597	37.5445	-216.7871
4.144	43.3893	36.7117	-218.7848	-0.5061	0.3174	38.8327	35.2147	-221.4433	47.9458	38.2087	-216.1263
4.16	41.7873	37.1036	-219.8674	-0.3884	0.2158	35.5056	35.7265	-222.499	48.069	38.4806	-217.2358
4.176	41.9033	37.2921	-221.4345	-0.3598	0.2436	36.7923	36.0221	-223.4156	47.0143	38.5621	-219.4533
4.192	41.357	37.1447	-222.8139	-0.376	0.3755	36.6563	35.2916	-224.8087	46.0577	38.9978	-220.8192
4.208	40.1512	37.1531	-223.3849	-0.3639	0.3596	34.3768	34.9821	-225.7343	45.9256	39.3241	-221.0355
4.224	41.5607	35.8901	-224.2213	-0.2835	0.3983	34.4133	32.8829	-226.4802	48.7081	38.8974	-221.9625
4.24	41.6992	37.171	-225.5603	-0.3312	0.4167	34.7842	34.1101	-228.1606	48.6141	40.2318	-222.96
4.256	40.6405	37.2318	-226.5076	-0.3208	0.3864	32.1728	33.7864	-229.5453	49.1082	40.6771	-223.4698
4.272	42.7563	34.864	-226.0653	-0.3263	0.6561	36.4077	29.9759	-228.7767	49.105	39.7521	-223.3539

Rock9

time	pos(x)	pos(y)	pos(z)	el	az	x1	y1	z1	x2	y2	z2
4.288	42.7338	34.6234	-227.2019	-0.3735	0.6335	35.7915	29.5249	-230.5773	49.676	39.7219	-223.8264
4.304	42.1303	35.3025	-228.4366	-0.3778	0.6283	35.5873	30.5492	-231.6461	48.6733	40.0559	-225.227
4.32	42.3056	35.0005	-229.3541	-0.4803	0.6916	36.6986	30.3576	-233.1472	47.9126	39.6435	-225.5611
4.336	40.8782	34.3896	-229.5404	-0.5058	0.9288	36.8093	28.9472	-233.3038	44.9471	39.832	-225.7769
4.352	41.6745	35.6554	-230.5352	-0.5273	1.0615	38.5642	30.0857	-234.2496	44.7847	41.2252	-226.8209
4.368	41.7233	35.5852	-231.6162	-0.5593	0.9262	37.8805	30.4729	-235.6197	45.566	40.6975	-227.6126
4.384	41.7337	35.3126	-232.1381	-0.548	1.1281	39.0022	29.5503	-236.0301	44.4652	41.0749	-228.2461
4.4	41.9474	34.5813	-233.2095	-0.4722	0.8952	37.3071	28.7908	-236.9993	46.5877	40.3717	-229.4196
4.416	42.2036	35.1228	-234.8225	-0.4364	0.8495	37.7503	30.0582	-237.9681	46.6569	40.1874	-231.6768
4.432	41.9565	34.591	-234.9078	-0.3771	0.8984	37.2099	28.6289	-237.9258	46.7031	40.5531	-231.8898
4.448	41.3401	34.3702	-235.3656	-0.3559	0.8371	36.0251	28.4748	-238.3166	46.6551	40.2657	-232.4146
4.464	42.1191	34.8725	-236.6553	-0.5053	0.863	37.6694	29.6722	-240.4417	46.5688	40.0728	-232.8689
4.48	41.9259	34.217	-237.7844	-0.5027	1.0102	38.5763	28.8815	-241.2478	45.2754	39.5524	-234.321
4.496	43.3331	34.5887	-239.549	-0.4083	0.8067	39.0129	30.08	-242.2506	47.6532	39.0974	-236.8475
4.512	41.8928	33.664	-240.8129	-0.3436	0.9995	38.4801	28.3552	-243.0713	45.3055	38.9729	-238.5545
4.528	41.447	34.092	-241.481	-0.2975	0.9332	37.4494	28.6954	-243.5404	45.4446	39.4886	-239.4216
4.544	41.6553	34.6012	-242.9355	-0.2848	0.7233	36.7632	30.2816	-244.846	46.5473	38.9208	-241.025
4.56	41.3221	33.3339	-243.9725	-0.3203	0.8687	37.5642	28.8915	-245.9026	45.08	37.7764	-242.0424
4.576	41.1716	32.8676	-244.9522	-0.2573	1.064	38.4083	27.8895	-246.4502	43.935	37.8457	-243.4543
4.592	41.2747	32.727	-245.1097	-0.2389	1.2083	38.7381	26.0384	-246.8516	43.8114	39.4157	-243.3678
4.608	41.7353	32.991	-246.8648	-0.205	1.2031	39.568	27.3645	-248.1184	43.9027	38.6176	-245.6112
4.624	41.2396	32.331	-247.3649	-0.2346	1.2938	39.6257	26.6534	-248.7753	42.8536	38.0087	-245.9544
4.64	41.3952	32.1088	-248.4338	-0.1923	1.1852	38.906	25.9762	-249.7225	43.8843	38.2414	-247.1452
4.656	41.4184	30.86	-248.7377	-0.1518	1.1257	38.3647	24.4578	-249.823	44.4722	37.2622	-247.6525
4.672	40.0601	30.2106	-250.4458	-0.2011	0.7566	34.4775	24.9408	-252.0107	45.6427	35.4805	-248.8809
4.688	38.5355	30.2909	-251.9079	-0.0893	0.7042	32.4083	25.0858	-252.628	44.6627	35.4961	-251.1877
4.704	40.214	30.3339	-252.7757	-0.1839	0.7258	34.7117	25.4508	-254.1442	45.7164	35.217	-251.4072
4.72	38.8787	28.9083	-254.7139	-0.135	0.574	31.1684	23.9227	-255.961	46.5891	33.8939	-253.4669
4.736	39.5528	29.5111	-254.6957	-0.0463	0.526	31.2315	24.6798	-255.1418	47.874	34.3425	-254.2496
4.752	39.0873	29.6839	-255.7395	-0.0147	0.3638	29.3754	25.9858	-255.8925	48.7991	33.382	-255.5865
4.768	40.0973	29.6369	-255.7419	0.0666	0.3637	31.5243	26.374	-255.1305	48.6704	32.8998	-256.3534
4.784	40.9623	28.3165	-258.0814	-0.0436	0.3423	32.6238	25.3449	-258.4674	49.3008	31.2881	-257.6953
4.8	39.9694	28.7857	-258.3182	-0.0549	0.2297	30.797	26.6408	-258.836	49.1417	30.9306	-257.8004
4.816	41.5029	28.5118	-258.7203	-0.0439	0.3008	33.9387	26.1656	-259.0681	49.0672	30.8579	-258.3726
4.832	39.3255	28.5937	-260.0444	0.0302	0.2445	30.6583	26.4313	-259.7742	47.9927	30.756	-260.3146
4.848	39.8924	28.499	-261.3213	0.0203	0.1074	29.8587	27.417	-261.1166	49.9262	29.581	-261.526
4.864	39.8239	27.9036	-262.5505	0.0253	0.077	28.7974	27.0531	-262.2709	50.8504	28.7541	-262.8302
4.88	38.7819	28.5546	-262.3798	0.0092	0.161	29.7899	27.0939	-262.296	47.7739	30.0154	-262.4636
4.896	38.8914	28.9939	-263.3852	0.0256	0.1049	30.0056	28.0583	-263.1562	47.7772	29.9294	-263.6142
4.912	40.7721	27.1258	-265.5157	0.0437	0.0638	30.9943	26.5014	-265.0876	50.5499	27.7502	-265.9438
4.928	40.1848	26.9831	-266.7987	0.0892	0.0591	30.8952	26.433	-265.9665	49.4744	27.5332	-267.6309
4.944	40.1164	27.0832	-266.6888	0.0447	-0.0123	31.1046	27.1938	-266.2855	49.1281	26.9726	-267.0921
4.96	38.541	27.3238	-267.9958	0.0959	-0.0599	30.1075	27.8291	-267.1832	46.9746	26.8184	-268.8084
4.976	38.4947	26.8287	-268.8534	0.0714	-0.0476	30.0976	27.2287	-268.2524	46.8918	26.4287	-269.4545
4.992	36.4507	27.4265	-269.7195	0.0472	0.0391	27.8722	27.0907	-269.3144	45.0292	27.7623	-270.1247
5.008	36.7428	26.2059	-271.076	0.0641	0.1053	29.7462	25.4663	-270.6244	43.7394	26.9455	-271.5276
5.024	37.797	26.1975	-271.5071	0.0662	0.0889	30.8406	25.5775	-271.0439	44.7534	26.8176	-271.9703
5.04	36.7317	26.2871	-271.7815	0.0806	-0.0224	28.902	26.4625	-271.1487	44.5614	26.1118	-272.4142
5.056	37.5921	25.0114	-273.3749	-0.0245	0.0294	29.8209	24.7827	-273.5652	45.3633	25.2401	-273.1846
5.072	39.2317	24.9373	-274.54	-0.0259	0.0096	32.0693	24.8686	-274.7256	46.3941	25.0059	-274.3544
5.088	36.0775	25.7524	-275.3601	-0.0602	-0.1059	25.945	26.8294	-275.9742	46.2099	24.6753	-274.746
5.104	36.4967	24.6228	-276.5023	-0.1327	0.0227	26.7525	24.4012	-277.8037	46.2409	24.8444	-275.2009
5.12	38.1707	24.6833	-276.8309	-0.0764	-0.0394	31.1941	24.9586	-277.3653	45.1473	24.408	-276.2966
5.136	38.0468	24.2725	-277.9068	-0.1401	-0.0541	30.1542	24.6996	-279.0218	45.9395	23.8453	-276.7918
5.152	37.0093	24.3841	-278.4442	-0.1128	-0.0757	29.1178	24.9827	-279.3404	44.9008	23.7854	-277.548
5.168	38.0844	24.4415	-278.8489	-0.1293	-0.0905	31.2921	25.0581	-279.7356	44.8767	23.825	-277.9622
5.184	37.5915	23.8187	-280.8707	-0.2539	-0.0156	30.3097	23.9321	-282.7603	44.8733	23.7053	-278.9811
5.2	36.5717	24.2092	-281.582	-0.1862	-0.0253	30.2864	24.368	-282.7665	42.857	24.0505	-280.3976
5.216	36.0084	23.9527	-282.8961	-0.1332	-0.0812	29.2906	24.4993	-283.7989	42.7262	23.406	-281.9932
5.232	37.4069	23.0718	-283.7855	-0.0321	-0.1963	31.374	24.2714	-283.9831	43.4398	21.8722	-283.5879
5.248	37.7115	24.2094	-283.5928	-0.0486	-0.3063	32.8422	25.7495	-283.8412	42.5809	22.6692	-283.3443
5.264	37.3942	24.7162	-285.4432	-0.1336	-0.3301	32.0916	26.5331	-286.1967	42.6968	22.8993	-284.6896
5.28	36.3085	24.2598	-286.8259	-0.204	-0.2427	29.9375	25.8372	-288.1837	42.6794	22.6824	-285.4681
5.296	37.1908	24.0418	-286.7395	-0.0884	-0.3559	30.9638	26.3564	-287.3285	43.4179	21.7273	-286.1506
5.312	37.1694	23.8946	-287.3148	-0.0743	-0.407	31.9475	26.1459	-287.7383	42.3913	21.6433	-286.8913
5.328	35.1106	23.7442	-288.6067	-0.0042	-0.464	29.8797	26.3616	-288.6315	40.3414	21.1268	-288.582

Rock9											
time	pos(x)	pos(y)	pos(z)	el	az	x1	y1	z1	x2	y2	z2
5.344	35.738	23.9847	-289.5333	-0.03	-0.5227	31.1384	26.6347	-289.6929	40.3376	21.3348	-289.3738
5.36	36.7877	23.6422	-290.2305	0.0977	-0.7312	33.3755	26.7034	-289.781	40.2	20.5811	-290.68
5.376	35.825	23.7086	-291.4612	0.1006	-0.9849	34.3747	25.8942	-291.1963	37.2753	21.523	-291.726
5.392	34.1572	23.3997	-292.336	0.1597	-1.0993	33.1569	25.3616	-291.9813	35.1575	21.4377	-292.6906

Rockan											
time	pos(x)	pos(y)	pos(z)	el	az	x1	y1	z1	x2	y2	z2
0	0	0	0	1.2395	0.9242	-1.4501	-1.9209	6.9968	1.4501	1.9209	-6.9968
0.016	0.5337	2.2865	-4.2687	1.1736	0.3667	-2.1362	1.2609	2.5496	3.2036	3.3121	-11.0871
0.032	1.1941	1.9122	-7.611	1.074	0.4262	-2.2004	0.3709	-0.7348	4.5885	3.4536	-14.4871
0.048	2.7925	2.5145	-12.2025	1.0842	0.2726	-0.6746	1.545	-5.3965	6.2597	3.4839	-19.0084
0.064	1.9567	2.8342	-15.0436	0.9744	0.3982	-1.7904	1.258	-9.0558	5.7038	4.4104	-21.0313
0.08	3.5506	3.7292	-18.5882	0.8325	0.3714	-0.7852	2.0406	-13.4752	7.8864	5.4179	-23.7011
0.096	4.1009	4.2065	-20.7225	0.8835	0.4052	0.3421	2.5942	-15.7395	7.8597	5.8189	-25.7054
0.112	5.8937	5.1545	-22.8774	0.8693	0.3051	1.9495	3.9122	-17.9826	9.8379	6.3967	-27.7722
0.128	7.3982	5.6549	-26.5576	0.778	0.4361	3.1628	3.681	-21.9537	11.6337	7.6289	-31.1616
0.144	8.6195	6.1086	-28.7837	0.825	0.3446	3.966	4.4382	-23.4317	13.273	7.779	-34.1357
0.16	10.1141	7.5024	-30.9041	0.802	0.2913	5.0684	5.9896	-25.459	15.1597	9.0151	-36.3492
0.176	12.4681	8.0797	-33.2598	0.6029	0.4063	6.7883	5.6357	-29.0028	18.148	10.5237	-37.5167
0.192	14.8145	8.781	-35.3309	0.6106	0.2888	8.7026	6.9649	-30.869	20.9264	10.5971	-39.7929
0.208	16.1548	8.5772	-38.2923	0.5751	0.3576	9.8096	6.2061	-33.9021	22.5	10.9484	-42.6825
0.224	17.8485	9.4358	-40.4231	0.5165	0.4034	11.607	6.7719	-36.5691	24.0901	12.0997	-44.2772
0.24	30.6528	-48.8474	-76.6785	-0.4719	0.6359	13.624	6.9518	-38.6781	26.6199	13.0264	-45.0369
0.256	23.2732	10.3877	-45.9948	0.2844	0.3931	15.6445	7.2238	-43.5801	30.902	13.5517	-48.4094
0.272	26.6062	11.6141	-46.8515	0.2639	0.4143	19.3159	8.4084	-44.6995	33.8964	14.8197	-49.0036
0.288	28.8222	12.5577	-48.9038	0.2419	0.3907	21.0761	9.367	-46.8363	36.5683	15.7483	-50.9712
0.304	29.1277	12.1063	-51.0185	0.0319	0.5218	20.2981	7.0299	-50.6931	37.9574	17.1828	-51.344
0.32	32.0116	13.4689	-52.2903	0.007	0.5239	24.062	8.8763	-52.2262	39.9611	18.0615	-52.3544
0.336	36.1125	14.4825	-53.7089	-0.0223	0.5063	28.1203	10.051	-53.9127	44.1047	18.9139	-53.505
0.352	36.3841	14.9333	-53.7596	-0.0756	0.5925	29.0402	9.9894	-54.4299	43.7281	19.8772	-53.0894
0.368	40.3367	15.5942	-54.319	-0.1867	0.5502	34.0338	11.728	-55.7159	46.6396	19.4604	-52.9221
0.384	42.3008	15.6871	-55.7176	-0.1299	0.4526	34.9913	12.1328	-56.7794	49.6103	19.2413	-54.6559
0.4	45.2832	16.9199	-56.9221	-0.256	0.5993	39.0784	12.6812	-58.889	51.4879	21.1586	-54.9552
0.416	48.3537	17.6105	-57.2248	-0.4676	0.606	43.1246	13.9866	-60.4371	53.5827	21.2344	-54.0126
0.432	49.0533	18.0767	-57.5973	-0.6626	0.9181	46.1174	14.2362	-61.3694	51.9891	21.9173	-53.8251
0.448	51.6832	18.446	-58.3818	-0.6989	0.9876	49.2869	14.814	-62.0388	54.0796	22.0779	-54.7248
0.464	52.864	18.8465	-59.0642	-0.6809	0.9913	50.2228	14.8104	-62.9716	55.5051	22.8826	-55.1569
0.48	55.7522	19.7847	-59.632	-0.6539	1.0744	53.6248	15.8566	-63.0552	57.8795	23.7129	-56.2088
0.496	58.2378	20.6285	-59.6505	-0.7293	1.0607	56.2557	17.0859	-63.2786	60.22	24.1711	-56.0225
0.512	58.9064	21.3898	-60.9403	-0.7428	1.6337	59.1685	17.2275	-64.7702	58.6444	25.5521	-57.1104
0.528	61.3173	20.9758	-62.3392	-0.7241	1.5269	61.1399	16.9391	-65.9126	61.4947	25.0124	-58.7657
0.544	60.3942	20.2995	-61.7751	-0.7075	1.972	61.9491	16.6346	-65.1797	58.8394	23.9644	-58.3705
0.56	62.8198	21.4251	-62.9201	-0.7249	2.1507	64.7987	18.4039	-66.1191	60.8409	24.4463	-59.7211
0.576	64.9211	19.9648	-63.9275	-0.5917	2.5363	68.9737	17.1608	-67.2395	60.8686	22.7688	-60.6155
0.592	66.8083	20.867	-65.1037	-0.2821	2.7609	72.5732	18.5596	-66.9032	61.0433	23.1744	-63.3043
0.608	69.6523	21.2891	-64.7055	-0.3097	2.8332	76.9237	18.9729	-67.1479	62.381	23.6052	-62.2631
0.624	69.4087	21.4669	-65.943	-0.1023	2.7381	75.9066	18.6927	-66.6684	62.9107	24.2411	-65.2176
0.64	71.8358	21.6614	-67.2742	-0.0347	2.7742	79.4961	18.7131	-67.5591	64.1755	24.6098	-66.9892
0.656	73.0085	22.1092	-67.352	0.0553	2.7469	79.8468	19.2608	-66.9416	66.1702	24.9575	-67.7624
0.672	75.411	22.3919	-67.8681	0.203	2.719	81.3516	19.7203	-66.5272	69.4704	25.0634	-69.2091
0.688	76.7149	22.9458	-67.7857	0.2711	2.7638	83.4019	20.2922	-65.7863	70.0279	25.5994	-69.7851
0.704	79.3389	23.1892	-67.7579	0.4091	2.9301	86.0844	21.7408	-64.7665	72.5934	24.6376	-70.7494
0.72	80.5667	23.7808	-68.5275	0.3962	2.8636	87.0442	21.9319	-65.7097	74.0892	25.6297	-71.3452
0.736	80.0143	24.5207	-68.1334	0.4681	2.7157	86.0565	21.7796	-64.7792	73.9721	27.2619	-71.4877
0.752	79.4197	25.5946	-67.732	0.8401	2.7772	84.2481	23.753	-61.9653	74.5912	27.4363	-73.4986
0.768	80.9262	24.8959	-68.4562	0.7839	2.7672	85.9808	22.91	-63.0413	75.8715	26.8817	-73.871
0.784	82.3526	25.8509	-69.1348	0.7985	2.7493	87.5609	23.6962	-63.3492	77.1443	28.0055	-74.9204
0.8	83.7553	25.824	-69.0261	0.836	2.7511	88.787	23.7526	-63.0036	78.7236	27.8955	-75.0486
0.816	84.086	26.7758	-69.1714	1.0205	2.5826	87.3591	24.7283	-62.8791	80.8128	28.8232	-75.4636
0.832	84.6104	27.176	-69.259	1.058	2.4436	87.5161	24.7383	-62.5233	81.7047	29.6137	-75.9946
0.848	83.7386	27.3924	-69.2157	1.1336	2.1675	85.4983	24.802	-62.5153	81.9789	29.9827	-75.9161
0.864	86.9161	27.4232	-70.1206	1.0808	2.6233	90.0942	25.6109	-63.2615	83.738	29.2355	-76.9796
0.88	87.1651	27.8234	-70.3011	1.0749	2.472	90.0624	25.5296	-63.47	84.2678	30.1171	-77.1322
0.896	87.9869	28.3168	-71.3799	0.9487	2.7205	92.5707	26.2636	-64.3748	83.403	30.37	-78.3849
0.912	88.3366	27.8577	-70.712	0.9636	2.7223	92.5013	26.0012	-64.1487	84.172	29.7141	-77.2754

Rock10

time	pos(x)	pos(y)	pos(z)	el	az	x1	y1	z1	x2	y2	z2
0.928	88.9402	29.6317	-70.8978	1.0162	2.6773	92.6453	27.7763	-64.2084	85.2351	31.487	-77.5872
0.944	88.8779	29.224	-71.0782	1.1426	2.7446	91.903	27.9557	-63.8925	85.8528	30.4923	-78.2639
0.96	90.2071	29.788	-71.2372	0.9968	2.6174	93.7826	27.7207	-64.8503	86.6316	31.8554	-77.624
0.976	91.5932	30.3172	-71.6719	1.0373	2.4995	94.9114	27.8359	-64.6561	88.2749	32.7984	-78.6878
0.992	92.775	30.8691	-73.0914	1.1252	2.3773	95.1113	28.6294	-66.3159	90.4387	33.1088	-79.8669
1.008	93.193	30.9051	-73.7105	1.0851	2.3939	95.9578	28.3412	-66.5681	90.4282	33.4689	-80.8528
1.024	93.6187	31.386	-74.9155	1.0031	2.4451	97.1078	28.4683	-67.7832	90.1296	34.3037	-82.0478
1.04	93.4706	32.3615	-75.3838	0.9601	2.457	97.0126	29.4701	-68.8515	89.9285	35.2529	-81.916
1.056	93.1539	32.7263	-77.0025	0.9029	2.5871	97.5773	29.9871	-70.407	88.7306	35.4656	-83.598
1.072	93.7611	33.1093	-77.2326	0.9507	2.555	97.7546	30.4553	-70.5177	89.7677	35.7633	-83.9475
1.088	94.4338	33.943	-78.5887	0.9908	2.4889	97.7837	31.3823	-72.1522	91.0839	36.5037	-85.0252
1.104	94.1051	33.7748	-79.5446	1.0223	2.4903	97.4822	31.2004	-72.5945	90.728	36.3491	-86.4947
1.12	94.2946	34.2782	-80.9989	0.9029	2.6982	98.9234	32.0801	-74.5028	89.6658	36.4764	-87.4949
1.136	93.9391	34.6165	-82.0953	0.9989	2.625	97.6116	32.5301	-75.5325	90.2665	36.7028	-88.6582
1.152	93.5182	34.3967	-82.9148	1.0525	2.8308	97.288	33.1858	-75.9717	89.7485	35.6076	-89.858
1.168	92.8252	35.6313	-84.4132	0.8874	2.8314	98.0716	33.9498	-77.6472	87.5787	37.3127	-91.1791
1.184	92.3179	34.8509	-86.0665	0.9545	2.7294	96.7802	32.8997	-79.1908	87.8556	36.8022	-92.9423
1.2	91.8488	34.7162	-87.8375	0.9467	2.7231	96.2508	32.7584	-81.1473	87.4469	36.6741	-94.5278
1.216	91.7633	35.9122	-88.5361	0.8247	2.8116	97.6141	33.9083	-81.845	85.9125	37.9162	-95.2272
1.232	91.6543	36.4755	-90.4408	0.8335	2.7689	97.2045	34.3052	-83.8789	86.104	38.6457	-97.0027
1.248	90.5598	36.976	-91.7582	0.855	2.7597	95.8965	34.8326	-85.1448	85.2231	39.1194	-98.3717
1.264	90.3613	36.8181	-93.292	0.7605	2.9243	96.8757	35.3799	-86.9445	83.8468	38.2563	-99.6396
1.28	90.78	37.6899	-94.1535	0.7413	3.0546	98.4525	37.0211	-87.1029	83.1075	38.3587	-101.204
1.296	89.7036	38.2102	-95.6072	0.6032	2.9692	97.5239	36.8485	-90.1387	81.8834	39.5718	-101.0758
1.312	87.9559	38.1135	-98.2424	0.5765	2.9541	96.0072	36.5864	-92.9148	79.9046	39.6406	-103.5701
1.328	88.0505	38.497	-99.0419	0.5225	2.9147	95.8385	36.6986	-94.439	80.2625	40.2954	-103.6448
1.344	87.7347	38.8672	-100.1987	0.5176	3.0276	95.7588	37.9489	-95.6007	79.7107	39.7855	-104.7968
1.36	87.009	38.8118	-101.5299	0.3968	2.945	95.7114	37.0783	-97.8114	78.3066	40.5454	-105.2484
1.376	86.6527	39.1747	-103.5295	0.4041	2.9101	94.7729	37.2604	-99.9618	78.5326	41.0891	-107.0972
1.392	84.8536	38.93	-104.8597	0.3108	3.0053	93.551	37.7375	-102.0399	76.1562	40.1224	-107.6795
1.408	85.0283	39.0078	-106.5414	0.2198	3.057	94.1193	38.2371	-104.5035	75.9373	39.7785	-108.5793
1.424	83.3745	39.047	-107.4367	0.2623	2.9927	92.5266	37.6746	-104.952	74.2225	40.4194	-109.9214
1.44	82.8228	39.0223	-108.7768	0.1793	3.0514	91.9923	38.1932	-107.1084	73.6533	39.8513	-110.4453
1.456	81.9148	38.5453	-110.3995	0.0729	2.8969	90.8662	36.3101	-109.7255	72.9633	40.7804	-111.0736
1.472	79.3835	38.1141	-111.0257	0.0911	2.9891	87.9652	36.7954	-110.2325	70.8018	39.4328	-111.819
1.488	78.2914	38.5275	-112.1667	-0.0504	2.8051	86.3779	35.6993	-112.5992	70.2049	41.3557	-111.7342
1.504	74.8488	37.6158	-113.1715	0.0418	2.9604	84.798	35.7934	-112.7482	64.8995	39.4382	-113.5948
1.52	74.0403	38.4394	-114.6799	0.0995	2.7913	80.8071	35.9674	-113.9608	67.2735	40.9114	-115.3989
1.536	73.0797	38.861	-115.4762	0.1001	2.791	79.8842	36.3729	-114.7483	66.2752	41.3492	-116.2042
1.552	71.5175	38.2397	-115.9374	0.0216	2.6046	76.8767	35.0494	-115.8025	66.1583	41.43	-116.0723
1.568	70.189	37.7626	-115.7509	0.0276	2.8161	76.1554	35.7487	-115.577	64.2225	39.7766	-115.9248
1.584	70.8267	38.1524	-117.3716	0.0173	2.4376	75.3261	34.3315	-117.2693	66.3273	41.9734	-117.474
1.6	70.4092	38.1102	-116.8851	0.2855	1.1315	69.506	36.1877	-116.2616	71.3125	40.0326	-117.5086
1.616	68.8817	37.447	-118.1837	0.3747	1.1356	67.6292	34.7532	-117.0152	70.1341	40.1409	-119.3522
1.632	68.9434	38.7477	-118.1183	0.4373	1.2774	67.9279	35.3861	-116.4766	69.959	42.1092	-119.76
1.648	69.7308	39.1727	-119.4318	0.2735	1.1539	68.1993	35.7143	-118.3708	71.2622	42.6312	-120.4928
1.664	69.6938	38.8778	-119.558	0.2043	0.6755	66.1043	36.0017	-118.6051	73.2833	41.754	-120.5109
1.68	70.3219	39.0855	-120.0904	0.2525	0.5264	66.4703	36.8473	-118.941	74.1734	41.3237	-121.2398
1.696	68.5376	40.1919	-120.0659	0.2469	0.6128	64.3785	37.2679	-118.7843	72.6967	43.1159	-121.3476
1.712	67.1726	39.7114	-120.7094	0.2072	0.6267	63.0299	36.7118	-119.6343	71.3153	42.7111	-121.7846
1.728	67.921	40.0749	-121.5557	0.101	0.537	63.1932	37.2601	-120.9981	72.6487	42.8897	-122.1132
1.744	67.6877	39.7118	-121.9603	0.0705	0.7254	63.9604	36.4072	-121.6083	71.4149	43.0163	-122.3123
1.76	65.1937	41.6816	-122.2682	0.1608	0.8417	62.3064	38.4495	-121.5653	68.081	44.9136	-122.9712
1.776	63.561	42.3852	-121.8581	0.1208	0.9501	61.6021	39.6451	-121.4492	65.52	45.1253	-122.2671
1.792	64.6415	41.9668	-123.236	-0.0167	0.8433	62.2632	39.2958	-123.2959	67.0198	44.6378	-123.1762
1.808	63.8853	41.9643	-124.0352	0	0.9068	61.5051	38.9227	-124.0351	66.2656	45.0059	-124.0353
1.824	63.4884	43.0147	-124.4848	-0.0606	0.9134	61.0219	39.8197	-124.7298	65.9549	46.2097	-124.2398
1.84	63.2227	43.6987	-124.956	-0.017	0.7473	60.4655	41.1442	-125.0201	65.9798	46.2533	-124.8919
1.856	62.7276	43.0135	-125.2786	-0.0425	0.867	60.2639	40.111	-125.4404	65.1913	45.916	-125.1167
1.872	63.7307	43.353	-125.7814	0.0377	0.8263	60.9456	40.3302	-125.6265	66.5158	46.3758	-125.9362
1.888	63.8309	43.6202	-126.5072	-0.0979	0.8388	61.4629	40.9846	-126.8553	66.199	46.2557	-126.1592
1.904	64.2603	43.9455	-127.443	-0.0364	0.9241	62.0446	41.0109	-127.577	66.476	46.88	-127.309
1.92	63.442	44.1275	-127.9627	-0.2136	1.0669	62.055	41.612	-128.5857	64.829	46.6431	-127.3397
1.936	63.9465	44.7045	-127.9856	-0.7417	2.1518	65.3589	42.5533	-130.3434	62.5341	46.8557	-125.6278
1.952	63.6511	45.4181	-127.6313	-0.7111	2.4656	65.8819	43.6289	-130.0948	61.4202	47.2073	-125.1678
1.968	64.7462	45.0724	-128.0874	-0.7135	2.4631	66.9584	43.2892	-130.5469	62.5341	46.8557	-125.6278

Rock10

time	pos(x)	pos(y)	pos(z)	el	az	x1	y1	z1	x2	y2	z2
1.984	64.7315	45.1427	-128.8128	-0.7634	2.5622	67.0912	43.5989	-131.5111	62.3719	46.6865	-126.1145
2	63.0655	45.4736	-129.3722	-0.9017	2.5202	64.9033	44.1578	-132.2304	61.2277	46.7894	-126.5141
2.016	62.8538	45.0024	-129.6993	-0.6719	2.6378	65.7458	43.4083	-132.3256	59.9618	46.5965	-127.0731
2.032	63.2004	45.7303	-130.2164	-0.5394	2.7473	66.2642	44.4555	-132.2203	60.1367	47.0051	-128.2298
2.048	62.8853	46.2742	-130.4393	-0.8088	2.7915	65.4713	45.33	-133.3243	60.2994	47.2185	-127.5544
2.064	62.7989	46.109	-130.97	-0.619	2.8947	65.4863	45.4317	-132.9442	60.1116	46.7864	-128.9958
2.08	61.9018	46.9216	-132.2446	-0.6089	3.0673	64.7736	46.7078	-134.2525	59.0301	47.1355	-130.2368
2.096	61.7698	46.7019	-132.1084	-0.5333	2.9413	65.6336	45.9176	-134.436	57.9059	47.4863	-129.7808
2.112	60.7904	47.1706	-133.0226	-0.4936	3.0306	63.6374	46.8533	-134.5638	57.9434	47.4879	-131.4813
2.128	60.4541	48.2315	-132.7376	-0.4701	3.1266	65.9531	48.1488	-135.5321	54.9552	48.3141	-129.943
2.144	61.1399	49.0354	-133.527	-0.394	-3.0129	67.3344	49.8371	-136.1236	54.9454	48.2338	-130.9303
2.16	62.181	49.0421	-133.9257	-0.3053	3.0994	68.1985	48.7879	-135.8241	56.1634	49.2963	-132.0273
2.176	61.0971	49.1842	-133.4306	-0.3947	-3.0922	67.3111	49.4914	-136.0225	54.8832	48.8769	-130.8387
2.192	61.6027	48.6544	-135.0274	-0.3838	-3.1061	68.2005	48.8887	-137.6938	55.0048	48.4202	-132.361
2.208	61.3163	49.6168	-136.3151	-0.3504	-3.0742	68.6698	50.1129	-139.0085	53.9627	49.1207	-133.6218
2.224	62.521	49.2664	-137.13	-0.3272	-3.1178	69.8761	49.4414	-139.6271	55.1658	49.0915	-134.6328
2.24	61.3018	50.5652	-137.8908	-0.3144	3.0893	68.9836	50.1629	-140.3921	53.62	50.9674	-135.3894
2.256	62.3459	50.8931	-138.3174	-0.2511	3.0989	69.516	50.5869	-140.1585	55.1758	51.1993	-136.4762
2.272	62.4163	49.7785	-140.1184	-0.2007	3.126	70.3828	49.6545	-141.7395	54.4497	49.9025	-138.4973
2.288	61.408	50.3733	-140.147	-0.1912	3.1251	68.7333	50.2524	-141.5653	54.0826	50.4941	-138.7287
2.304	61.9993	50.721	-141.5177	-0.1353	3.0512	69.0126	50.0852	-142.4765	54.986	51.3568	-140.559
2.32	62.052	50.9043	-141.6247	-0.1363	3.1086	69.8885	50.6454	-142.6997	54.2156	51.1631	-140.5497
2.336	61.6572	51.1601	-142.4892	-0.121	3.0872	70.2194	50.694	-143.5318	53.095	51.6261	-141.4466
2.352	61.412	51.64	-143.7599	-0.1167	3.1297	69.686	51.5412	-144.7299	53.138	51.7387	-142.7899
2.368	60.5232	52.195	-144.5883	-0.1057	3.0882	69.4455	51.7183	-145.5364	51.6009	52.6717	-143.6402
2.384	61.1736	52.3378	-145.4756	-0.1057	3.0806	69.4911	51.83	-146.3593	52.8562	52.8456	-144.5919
2.4	61.4937	51.5151	-146.4276	-0.0766	3.0598	70.3269	50.7906	-147.1077	52.6605	52.2397	-145.7476
2.416	62.0056	51.7691	-148.0568	0.0134	2.9918	70.1484	50.54	-147.9464	53.8628	52.9982	-148.1672
2.432	60.9254	51.971	-148.9216	0.0548	2.9908	69.5883	50.6544	-148.4412	52.2625	53.2876	-149.4021
2.448	61.7559	51.6092	-150.3964	0.0929	3.0426	67.8409	51.005	-149.827	55.6709	52.2134	-150.9659
2.464	64.4294	51.8887	-151.8951	0.0643	3.1208	71.9663	51.7319	-151.4094	56.8926	52.0455	-152.3808
2.48	65.4055	51.2143	-152.7335	0.0745	3.0238	73.8707	50.2126	-152.0973	56.9403	52.2161	-153.3696
2.496	64.1675	51.3535	-153.7113	0.0644	3.0413	73.9363	50.37	-153.0777	54.3987	52.3369	-154.3449
2.512	63.9798	50.9611	-154.5945	0.0434	3.0791	75.1377	50.2626	-154.1088	52.8218	51.6596	-155.0801
2.528	65.2532	51.1597	-155.598	0.1246	2.9823	75.9761	49.4371	-154.2377	54.5303	52.8823	-156.9582
2.544	62.0095	52.4819	-155.4783	0.0514	2.9914	73.5769	50.7317	-154.8767	50.4421	54.2321	-156.9508
2.56	61.5106	52.9724	-156.3576	-0.0023	2.8379	71.3219	49.8976	-156.3812	51.6994	56.0472	-156.334
2.576	61.4964	53.4601	-157.5783	0.013	2.796	71.6256	49.8134	-157.4384	51.3673	57.1069	-157.7182
2.592	61.9473	53.4379	-158.0885	-0.0188	2.803	72.5179	49.7153	-158.2991	51.3768	57.1605	-157.8779
2.608	60.8674	53.5589	-158.6365	0.0265	2.8333	71.4421	50.192	-158.342	50.2928	56.9259	-158.9309
2.624	61.6636	53.3917	-160.241	-0.083	2.7486	71.8668	49.1623	-161.1593	51.4603	57.6212	-159.3226
2.64	61.4172	54.5407	-160.5597	0.0102	2.5844	67.7167	50.6161	-160.4838	55.1176	58.4653	-160.6357
2.656	60.7535	54.8092	-160.8318	-0.059	2.7128	70.1357	50.5205	-161.4416	51.3712	59.0979	-160.2221
2.672	61.9576	54.3122	-162.1204	-0.0027	2.6643	68.9795	50.6811	-162.1415	54.9358	57.9433	-162.0994
2.688	61.9848	54.425	-163.3045	-0.066	2.6097	68.8153	50.4057	-163.8282	55.1543	58.4444	-162.7808
2.704	60.8424	54.9177	-164.6101	-0.017	2.7116	69.1413	51.1116	-164.7652	52.5434	58.7237	-164.455
2.72	61.6705	55.4647	-164.8867	-0.1074	2.5546	68.9169	50.6439	-165.8253	54.4242	60.2855	-163.948
2.736	60.7404	54.7871	-166.3442	-0.0585	2.6155	68.6908	50.1701	-166.8828	52.79	59.4041	-165.8057
2.752	58.8124	55.1904	-166.0973	-0.0352	2.7083	68.211	50.8426	-166.462	49.4138	59.5383	-165.7327
2.768	59.6772	55.6149	-167.8295	-0.038	2.719	68.0175	51.8648	-168.1769	51.3369	59.3649	-167.4822
2.784	58.267	56.0466	-168.7239	-0.1056	2.6082	66.9572	50.9156	-169.7935	49.5769	61.1775	-167.6543
2.8	58.6894	56.2733	-168.9669	-0.1157	2.5737	66.9799	50.9834	-170.1098	50.3988	61.5633	-167.8241
2.816	58.7227	55.736	-170.1225	-0.1	2.6934	69.6113	50.5009	-171.3351	47.8341	60.9712	-168.91
2.832	57.6641	56.6156	-171.0111	-0.1534	2.763	69.0832	52.0731	-172.9114	46.2451	61.1581	-169.1108
2.848	58.337	57.3492	-172.0602	-0.1219	2.7195	67.649	53.1669	-173.3105	49.0249	61.5314	-170.8099
2.864	59.3039	56.405	-172.6736	-0.2013	2.6467	67.7178	51.8643	-174.6248	50.89	60.9458	-170.7224
2.88	58.7352	57.9217	-173.6908	-0.1944	2.7488	68.8861	53.7162	-175.8547	48.5842	62.1273	-171.5269
2.896	57.8402	57.212	-174.3431	-0.2111	2.7666	67.4678	53.4229	-176.5607	48.2127	61.0011	-172.1256
2.912	59.1415	58.3265	-175.6408	-0.27	2.5964	68.4367	52.6894	-178.6496	49.8464	63.9637	-172.6319
2.928	55.9932	57.333	-175.6699	-0.3886	2.428	60.0304	53.838	-177.8564	51.9561	60.828	-173.4834
2.944	56.7908	57.479	-176.7425	-0.6051	2.2836	59.1166	54.7884	-179.2021	54.465	60.1695	-174.2829
2.96	57.7685	58.2969	-176.662	-0.7372	2.6551	61.106	56.5317	-180.0898	54.431	60.0622	-173.2343
2.976	57.0858	58.3723	-178.1335	-0.6638	2.0716	59.0934	54.7045	-181.4041	55.0782	62.0401	-174.8628
2.992	55.944	58.8641	-178.6064	-0.6341	2.0948	58.0137	55.2825	-181.6484	53.8743	62.4456	-175.5644
3.008	57.8002	58.2924	-179.4589	-0.7971	1.6939	58.1386	55.5573	-182.28	57.4618	61.0276	-176.6377
3.024	57.4034	59.0542	-180.4648	-0.6874	1.8476	58.2864	55.9454	-183.1179	56.5203	62.1631	-177.8117

Rock10

time	pos(x)	pos(y)	pos(z)	el	az	x1	y1	z1	x2	y2	z2
3.04	56.1848	59.467	-181.0502	-0.6781	2.1574	58.3783	56.1665	-184.2422	53.9913	62.7675	-177.8582
3.056	53.8651	59.3669	-181.3338	-0.644	2.6504	58.8159	56.7187	-185.5495	48.9143	62.0152	-177.1181
3.072	53.1161	59.9485	-182.5483	-0.5707	2.8437	58.7509	58.2186	-186.3319	47.4812	61.6784	-178.7648
3.088	54.0013	60.105	-182.428	-0.5929	2.818	59.4293	58.2844	-186.2853	48.5733	61.9256	-178.5708
3.104	55.4585	59.4357	-183.8145	-0.579	2.8901	61.3008	57.9347	-187.7578	49.6163	60.9367	-179.8711
3.12	55.5606	59.7055	-184.9041	-0.5559	2.9059	62.0662	58.1434	-189.061	49.055	61.2677	-180.7472
3.136	55.1073	59.9229	-186.2238	-0.5084	2.9436	61.72	58.5961	-189.9825	48.4945	61.2498	-182.465
3.152	55.0528	60.6659	-186.8489	-0.4766	2.9773	62.4082	59.4464	-190.698	47.6974	61.8855	-182.9998
3.168	54.9127	61.1887	-188.6393	-0.4682	2.992	61.7033	60.1653	-192.1121	48.1222	62.212	-185.1665
3.184	55.6926	61.0441	-189.3325	-0.4267	2.9601	63.1972	59.6667	-192.8011	48.188	62.4215	-185.8638
3.2	55.9685	60.8474	-190.3523	-0.4354	2.9756	64.15	59.477	-194.2113	47.787	62.2177	-186.4932
3.216	57.3441	60.4609	-191.1113	-0.3849	2.9606	65.927	58.8903	-194.6461	48.7611	62.0314	-187.5764
3.232	56.2241	61.0924	-192.3543	-0.3501	2.9564	65.4737	59.3598	-195.7908	46.9746	62.8249	-188.9179
3.248	58.5895	60.642	-193.7126	-0.3343	2.9647	67.6361	58.8464	-197.2573	47.5429	62.4376	-190.1678
3.264	58.0877	60.9825	-194.6985	-0.3185	2.9432	66.4912	59.2934	-197.5247	49.6841	62.6716	-191.8722
3.28	58.5853	60.4871	-195.5062	-0.2734	2.9105	67.0153	58.5035	-197.9345	50.1552	62.4708	-193.0779
3.296	59.2672	60.9102	-196.432	-0.2776	2.9494	68.9531	59.0249	-199.2442	49.5813	62.7955	-193.6198
3.312	58.9334	61.3166	-198.1768	-0.2182	2.9401	68.1338	59.4375	-200.2587	49.733	63.1956	-196.0949
3.328	58.7116	61.2299	-199.153	-0.1599	2.9206	68.6218	59.0035	-200.7907	48.8015	63.4564	-197.5153
3.344	60.1427	60.9699	-199.6372	-0.1718	2.9267	70.5194	58.7045	-201.4798	49.766	63.2353	-197.7946
3.36	60.2568	61.2405	-200.916	-0.1894	2.9337	70.9986	58.9752	-203.02	49.5151	63.5058	-198.8119
3.376	60.0223	61.4735	-201.9804	-0.1136	2.9179	70.3945	59.114	-203.1945	49.65	63.8331	-200.7662
3.392	59.2919	61.8109	-202.4708	-0.0779	2.8471	68.6665	58.9674	-203.2354	49.9173	64.6544	-201.7061
3.408	60.055	61.5047	-204.3493	-0.0838	2.8385	69.8394	58.4448	-205.2108	50.2707	64.5646	-203.4877
3.424	60.8959	61.357	-205.5221	-0.0781	2.8933	71.022	58.7895	-206.3399	50.7698	63.9246	-204.7042
3.44	60.5014	62.4482	-206.6388	-0.0766	2.9223	70.9779	60.1136	-207.4621	50.0248	64.7827	-205.8155
3.456	60.5439	62.0904	-207.1552	-0.1143	2.891	70.4153	59.5641	-208.3248	50.6726	64.6167	-205.9856
3.472	61.6258	63.5516	-208.9524	-0.1033	2.8621	71.6147	60.6842	-210.0294	51.6368	66.419	-207.8754
3.488	61.5988	62.5166	-209.8848	-0.1047	2.8859	71.9481	59.8106	-211.0087	51.2494	65.2225	-208.761
3.504	63.1357	63.3856	-210.3529	-0.0116	2.8941	74.9299	60.405	-210.494	51.3416	66.3662	-210.2117
3.52	64.3134	63.5248	-211.5703	0.0302	2.8165	76.1906	59.5219	-211.1922	52.4361	67.5276	-211.9483
3.536	62.6813	63.6004	-212.5814	0.0072	2.8406	74.0995	60.0557	-212.4957	51.263	67.1452	-212.6671
3.552	63.4521	64.1045	-213.9789	-0.0156	2.8328	74.1053	60.7067	-214.1533	52.7988	67.5023	-213.8046
3.568	60.4062	64.4736	-214.3022	0.0073	2.7995	70.3077	60.9481	-214.2254	50.5046	67.9991	-214.379
3.584	61.9763	64.7474	-215.9923	0.0645	2.7961	71.8269	61.2016	-215.3158	52.1256	68.2932	-216.6688
3.6	62.8537	65.1132	-216.9464	0.1385	2.8276	73.3788	61.6954	-215.4039	52.3285	68.5311	-218.4888
3.616	61.4407	65.0778	-218.0287	0.0787	2.7896	71.8719	61.2465	-217.1525	51.0094	68.9092	-218.9048
3.632	61.6836	63.6161	-219.7283	0.0463	2.84	71.6168	60.5264	-219.2468	51.7504	66.7057	-220.2098
3.648	61.2806	64.5348	-220.0166	0.0301	2.8361	71.9093	61.1831	-219.6809	50.652	67.8866	-220.3522
3.664	62.2177	63.1091	-220.9746	0.124	2.8824	72.866	60.2855	-219.6019	51.5694	65.9327	-222.3473
3.68	61.3402	64.184	-223.2455	0.0321	2.8398	70.6923	61.2732	-222.9307	51.9881	67.0949	-223.5602
3.696	63.8289	63.67	-223.041	0.0995	2.8723	75.6707	60.4014	-221.8144	51.9872	66.9386	-224.2677
3.712	61.9681	62.1862	-224.506	0.1305	2.8388	72.3501	58.9432	-223.0789	51.5861	65.4291	-225.9331
3.728	64.0244	62.2033	-224.9267	0.2101	2.8878	75.1397	59.3198	-222.4785	52.9091	65.0868	-227.375
3.744	65.0326	61.2446	-225.8981	0.1529	2.8768	76.0579	58.2546	-224.1373	54.0073	64.2346	-227.6588
3.76	58.5099	61.5792	-227.281	0.1565	2.8512	70.2764	58.0635	-225.343	46.7434	65.095	-229.2189
3.776	58.9889	62.1858	-228.1101	0.126	2.8834	71.71	58.8264	-226.443	46.2678	65.5451	-229.7772
3.792	56.8808	61.5934	-228.7588	0.1991	2.8887	68.4915	58.5929	-226.3394	45.2701	64.5939	-231.1781
3.808	58.5555	61.8243	-230.0406	0.1478	2.8813	69.6877	58.8593	-228.3248	47.4233	64.7893	-231.7564
3.824	57.9628	61.3634	-231.0246	0.1153	2.9046	69.3455	58.6136	-229.6687	46.5801	64.1132	-232.3806
3.84	57.2945	62.6783	-232.1714	0.1103	2.8965	68.9314	59.7674	-230.8427	45.6575	65.5891	-233.5
3.856	56.3837	60.7488	-233.7445	0.196	2.9029	66.9346	58.1817	-231.5887	45.8327	63.316	-235.9004
3.872	56.6688	60.8791	-233.2568	0.0865	2.8109	67.5397	57.1467	-232.2604	45.7979	64.6116	-234.2532
3.888	57.8584	62.6641	-234.6084	0.0594	2.7979	68.3538	58.9073	-233.9451	47.363	66.421	-235.2718
3.904	55.8616	62.7059	-235.2571	0.0462	2.8342	66.5229	59.3208	-234.7402	45.2003	66.0909	-235.7739
3.92	55.5127	62.1288	-236.1891	0.0053	2.8277	65.6711	58.8306	-236.1328	45.3542	65.4269	-236.2454
3.936	56.2122	61.5848	-237.6071	0.0536	2.8275	68.0387	57.7427	-236.9401	44.3856	65.4268	-238.274
3.952	53.946	62.4393	-238.7631	0.0078	2.7448	64.4704	58.0288	-238.6742	43.4215	66.8497	-238.8519
3.968	55.3646	62.5338	-240.1797	0.0302	2.7753	66.2877	58.3435	-239.8258	44.4415	66.724	-240.5335
3.984	55.0898	62.7799	-240.6462	0.0019	2.7455	66.5576	57.9847	-240.6221	43.622	67.5751	-240.6703
4	54.1529	62.8884	-241.2888	-0.0348	2.7772	65.8506	58.4268	-241.7245	42.4552	67.3501	-240.853
4.016	52.9457	62.7407	-242.5673	-0.0215	2.7594	64.0926	58.2596	-242.8259	41.7988	67.2218	-242.3087
4.032	53.7333	62.8286	-243.3989	-0.0824	2.7832	64.6681	58.7326	-244.3636	42.7985	66.9246	-242.4342
4.048	52.0779	63.1171	-244.3654	-0.0648	2.7761	64.0125	58.5495	-245.194	40.1432	67.6846	-243.5368
4.064	52.7126	62.6782	-245.7302	-0.0801	2.7289	63.7695	57.8368	-246.6987	41.6556	67.5195	-244.7617
4.08	51.2357	62.9446	-246.5797	-0.1599	2.6983	62.4912	57.6006	-248.5891	39.9802	68.2886	-244.5703

Rock10

time	pos(x)	pos(y)	pos(z)	el	az	x1	y1	z1	x2	y2	z2
4.096	51.2442	63.2336	-247.3914	-0.1572	2.7823	62.9966	58.8189	-249.3812	39.4918	67.6484	-245.4015
4.112	50.8582	62.5689	-248.1857	-0.1605	2.7819	63.0484	57.9845	-250.2935	38.6681	67.1532	-246.0778
4.128	50.7195	63.4476	-248.9877	-0.1934	2.803	62.6078	59.2609	-251.456	38.8312	67.6343	-246.5193
4.144	49.8845	63.5006	-250.6614	-0.188	2.8044	62.6028	59.0417	-253.2257	37.1663	67.9594	-248.0971
4.16	48.8269	63.2471	-250.9638	-0.2311	2.8088	61.3177	58.9292	-254.0736	36.336	67.5649	-247.8539
4.176	50.006	63.219	-252.2001	-0.2705	2.7989	61.8281	59.0018	-255.6803	38.1838	67.4361	-248.72
4.192	50.8411	63.3368	-253.6863	-0.2084	2.8263	63.3174	59.2676	-256.4615	38.3647	67.406	-250.911
4.208	48.6571	62.9202	-253.828	-0.1976	2.8487	60.5971	59.3196	-256.3253	36.7171	66.5208	-251.3306
4.224	49.5048	63.2064	-254.8829	-0.2213	2.836	61.1232	59.5414	-257.6242	37.8863	66.8714	-252.1416
4.24	49.651	62.9437	-255.6321	-0.2506	2.8315	61.412	59.1753	-258.7937	37.89	66.712	-252.4704
4.256	48.9157	64.1891	-256.3227	-0.2594	2.9198	60.2693	61.6284	-259.4108	37.5622	66.7497	-253.2347
4.272	47.6686	63.975	-257.0203	-0.267	2.9232	59.4425	61.3616	-260.3198	35.8947	66.5884	-253.7208
4.288	48.3891	64.4356	-258.1714	-0.2925	3.0416	58.0002	63.4717	-261.0802	38.7779	65.3994	-255.2625
4.304	47.1425	64.8706	-259.5797	-0.2901	3.0167	58.1838	63.4844	-262.9022	36.1011	66.2569	-256.2572
4.32	50.2817	63.5053	-259.9548	-0.2686	2.986	61.7701	61.703	-263.1556	38.7932	65.3076	-256.7539
4.336	49.8772	63.9781	-261.1796	-0.3937	3.0227	59.6223	62.8138	-265.2567	40.1321	65.1425	-257.1024
4.352	47.8117	64.786	-260.6943	-0.3504	3.019	59.6784	63.3233	-265.0637	35.945	66.2486	-256.3249
4.368	47.7317	64.095	-262.0168	-0.3675	3.0177	58.1526	62.797	-266.0593	37.3107	65.3929	-257.9743
4.384	49.8677	63.6655	-263.7253	-0.2348	3.0641	63.733	62.5891	-267.052	36.0024	64.7419	-260.3986
4.4	51.4655	63.7708	-265.0578	-0.323	-3.1297	62.9294	63.9069	-268.8947	40.0016	63.6348	-261.2208
4.416	48.5191	64.4119	-266.1883	-0.2668	3.0643	62.3844	63.3385	-269.9898	34.6538	65.4853	-262.3869
4.432	50.0405	64.2552	-267.0517	-0.2553	3.0292	64.6001	62.6119	-270.8751	35.4808	65.8985	-263.2283
4.448	48.6148	64.7319	-268.1441	-0.2448	3.1273	62.5439	64.5328	-271.6247	34.6856	64.9311	-264.6635
4.464	47.4896	64.4412	-269.1912	-0.1445	3.0842	61.4501	63.6394	-271.2257	33.5291	65.243	-267.1566
4.48	49.3704	64.0425	-270.264	-0.1273	3.0786	63.8623	63.1286	-272.1221	34.8786	64.9564	-268.4059
4.496	49.0416	63.5086	-271.1955	-0.1176	3.1019	64.1731	62.9071	-272.9853	33.9102	64.11	-269.4056
4.512	49.2736	63.5115	-271.8988	-0.1323	3.0759	63.9771	62.5439	-273.8593	34.5701	64.4791	-269.9383
4.528	49.4712	63.0536	-273.1514	-0.1477	3.1139	64.1711	62.6466	-275.3394	34.7713	63.4606	-270.9633
4.544	49.131	64.1277	-273.5062	-0.0886	3.0598	63.7057	62.9331	-274.8056	34.5563	65.3223	-272.2068
4.56	50.2741	63.1158	-274.9572	-0.1159	-3.1335	64.7591	63.2333	-276.6438	35.789	62.9983	-273.2706
4.576	50.7241	62.9537	-275.3907	-0.0325	3.1237	65.3293	62.6928	-275.866	36.119	63.2146	-274.9153
4.592	51.7015	63.929	-275.8726	-0.012	3.1302	65.314	63.7744	-276.0359	38.0891	64.0836	-275.7093
4.608	50.5919	63.1978	-276.592	-0.0577	-3.0784	64.8767	64.1022	-277.4182	36.3071	62.2934	-275.7657
4.624	49.6355	62.7099	-278.2576	-0.0023	-3.0239	62.7627	64.262	-278.2874	36.5084	61.1577	-278.2278
4.64	50.7684	62.6426	-278.9307	-0.006	-3.0603	65.1925	63.818	-279.0175	36.3443	61.4672	-278.8438
4.656	50.269	61.5607	-279.2176	-0.0449	-3.0227	65.3025	63.3561	-279.8985	35.2355	59.7653	-278.5367
4.672	51.3115	64.1095	-280.5293	-0.0345	-3.0212	65.6307	65.8414	-281.0273	36.9923	62.3776	-280.0312
4.688	51.9532	62.278	-281.9582	-0.008	-3.0321	66.3846	63.864	-282.0737	37.5217	60.692	-281.8427
4.704	51.9329	63.4709	-282.3818	0.0359	-2.9746	66.66	65.9534	-281.845	37.2058	60.9884	-282.9186
4.72	51.5076	63.8723	-284.2915	0.0102	-2.9529	66.4485	66.7248	-284.1367	36.5668	61.0198	-284.4463
4.736	53.7303	63.6349	-285.6931	0.0386	-2.9628	68.0739	66.2264	-285.1309	39.3867	61.0433	-286.2554
4.752	54.2474	65.2597	-285.6547	0.0535	-2.9329	70.2602	68.6503	-284.7785	38.2346	61.8691	-286.5309
4.768	54.4316	63.1585	-285.6937	-0.0156	-2.9232	69.8092	66.5714	-285.9387	39.0539	59.7456	-285.4486
4.784	54.377	63.5472	-287.5884	0.0031	-3.0103	69.3513	65.524	-287.5412	39.4027	61.5704	-287.6357
4.8	53.5928	61.5317	-288.4708	0.1232	-3.0702	67.764	62.5459	-286.7112	39.4217	60.5176	-290.2305
4.816	52.895	62.918	-289.7934	0.1698	-3.1222	65.3791	63.1608	-287.6529	40.4109	62.6753	-291.9338
4.832	53.6578	63.5022	-290.9875	0.1913	3.1207	66.7264	63.2289	-288.4561	40.5892	63.7755	-293.5189
4.848	54.5578	61.9413	-291.7797	0.1743	3.129	67.5279	61.7778	-289.4951	41.5878	62.1048	-294.0643
4.864	51.6611	63.208	-293.9239	0.1876	3.1055	65.2104	62.7184	-291.3502	38.1118	63.6977	-296.4976
4.88	52.8401	62.3329	-293.7652	0.2272	3.084	64.7384	61.6472	-291.0093	40.9418	63.0186	-296.5211
4.896	53.5498	62.0197	-295.321	0.1644	3.0755	67.4747	61.0974	-293.0053	39.6249	62.9419	-297.6368
4.912	53.5681	62.7304	-294.6549	0.1438	3.0065	68.7101	60.6721	-292.4415	38.426	64.7887	-296.8683
4.928	53.0617	60.4759	-295.513	0.2115	3.0249	66.6491	58.8828	-292.5761	39.4743	62.0691	-298.4499
4.944	51.7205	60.6829	-296.3664	0.1832	3.0025	66.6194	58.5973	-293.5798	36.8215	62.7686	-299.153
4.96	53.1408	60.4987	-297.582	0.1315	2.9994	66.802	58.5435	-295.7574	39.4795	62.454	-299.4066
4.976	52.3328	60.7173	-298.6219	0.1026	2.9055	67.7076	57.0182	-296.9941	36.958	64.4165	-300.2498
4.992	50.8863	59.9133	-300.6606	0.1537	2.9731	65.0753	57.5183	-298.4312	36.6974	62.3443	-302.89
5.008	50.258	59.3574	-300.754	0.1642	2.9786	62.4818	57.3473	-298.7015	38.0342	61.3675	-302.8065
5.024	49.9476	58.6466	-300.6012	0.1113	2.9478	62.1265	56.2568	-299.2143	37.7686	61.0365	-301.9882
5.04	50.6178	58.4454	-302.48	0.0884	3.0207	63.5211	56.8774	-301.3283	37.7145	60.0133	-303.6317
5.056	47.3731	58.2088	-304.7377	0.0251	2.9772	60.958	55.9547	-304.3919	33.7881	60.4628	-305.0836
5.072	49.1231	57.1814	-305.0148	-0.0238	2.9715	60.7147	55.1909	-305.2948	37.5315	59.1718	-304.7347
5.088	47.9699	57.4834	-305.6551	0.0084	2.978	58.2785	55.782	-305.5678	37.6614	59.1848	-305.7425
5.104	48.0708	57.2385	-306.4598	0.0597	3.0164	57.0403	56.11	-305.9197	39.1013	58.3671	-307
5.12	44.2802	58.4959	-306.4208	0.1032	3.1008	53.4397	58.122	-305.4713	35.1207	58.8699	-307.3704
5.136	42.8625	58.4307	-307.3325	0.0697	3.0673	53.3354	57.651	-306.5988	32.3897	59.2104	-308.0662

Rock10

time	pos(x)	pos(y)	pos(z)	el	az	x1	y1	z1	x2	y2	z2
5.152	43.6263	57.5086	-308.7967	0.0554	3.0183	53.2878	56.3111	-308.257	33.9649	58.7061	-309.3364
5.168	42.1742	58.4394	-309.0188	0.0991	3.0251	53.1911	57.1503	-307.9157	31.1574	59.7284	-310.1218
5.184	40.838	58.1638	-309.474	0.0455	2.9786	53.1214	56.144	-308.9067	28.5546	60.1835	-310.0412
5.2	41.4618	56.5387	-310.3029	-0.0175	2.9731	53.2332	54.5359	-310.5119	29.6905	58.5414	-310.0939
5.216	40.8245	57.3113	-310.4608	-0.0789	2.8966	53.2186	54.2123	-311.4705	28.4304	60.4103	-309.4511
5.232	39.0524	57.7367	-311.546	-0.1429	2.8581	50.8778	54.291	-313.3181	27.227	61.1824	-309.7738
5.248	39.4162	59.0655	-312.7145	-0.088	2.8343	49.859	55.7514	-313.6811	28.9735	62.3796	-311.7479
5.264	39.0459	56.7929	-313.7184	-0.0646	2.8198	50.6415	52.9275	-314.5089	27.4502	60.6583	-312.9279
5.28	39.6963	56.4427	-314.5288	-0.1974	2.8221	49.4222	53.2248	-316.5782	29.9703	59.6606	-312.4794
5.296	39.3316	57.2384	-315.6423	-0.2146	2.8976	49.8419	54.6218	-318.0036	28.8212	59.855	-313.2811
5.312	39.1792	56.1367	-314.897	-0.2503	2.8498	48.343	53.3843	-317.3427	30.0154	58.889	-312.4512

Rockan

time	pos(x)	pos(y)	pos(z)	el	az	x1	y1	z1	x2	y2	z2
0	0	0	0	1.1725	0.6502	-2.1597	-1.6425	6.4487	2.1597	1.6425	-6.4487
0.024	0.7614	0.1026	-5.4491	1.1145	0.6426	-1.7668	-1.7898	0.9839	3.2896	1.995	-11.8822
0.048	1.5021	1.1722	-9.6862	1.1393	0.5888	-1.0794	-0.5517	-2.9434	4.0836	2.8961	-16.4289
0.072	2.8541	2.4432	-14.4867	1.0708	0.561	-0.2524	0.4913	-7.7704	5.9606	4.3952	-21.203
0.096	4.649	3.069	-18.1951	0.9236	0.6313	1.4149	0.7044	-12.8947	7.8832	5.4336	-23.4954
0.12	6.0243	3.2462	-23.6348	0.931	0.5539	2.2932	0.9384	-17.7399	9.7555	5.5539	-29.5297
0.144	8.3165	4.9592	-26.4275	0.9274	0.3043	4.0009	3.6039	-20.3952	12.6321	6.3144	-32.4598
0.168	11.4276	5.1217	-31.3013	0.8107	0.3261	6.4957	3.4538	-25.8243	16.3595	6.7896	-36.7783
0.192	13.4159	6.2927	-34.669	0.6845	0.4126	7.8198	3.8432	-29.6832	19.0121	8.7422	-39.6548
0.216	17.4631	6.9794	-37.6994	0.6852	0.299	11.2389	5.0612	-32.3765	23.6873	8.8977	-43.0223
0.24	19.2982	7.9747	-39.9323	0.6651	0.2997	13.151	6.0749	-34.8856	25.4455	9.8746	-44.979
0.264	23.5859	9.0619	-43.5557	0.5169	0.336	16.7851	6.6865	-39.4604	30.3867	11.4373	-47.651
0.288	26.9668	9.7559	-46.0446	0.4113	0.3538	19.4148	6.967	-42.5327	34.5187	12.5449	-49.5564
0.312	30.0492	11.0503	-48.459	0.2999	0.3486	21.6613	8.0017	-45.699	38.4372	14.0988	-51.2191
0.336	33.1335	11.3041	-51.446	0.2869	0.2971	25.0518	8.8294	-48.9523	41.2152	13.7788	-53.9398
0.36	37.6893	12.8008	-52.8657	0.1645	0.3608	29.6701	9.7749	-51.4428	45.7085	15.8266	-54.2885
0.384	41.2686	13.2075	-54.3875	0.1604	0.3743	32.6323	9.815	-52.8863	49.9048	16.6	-55.8887
0.408	43.2507	14.676	-56.0252	0.0854	0.3759	33.7875	10.9409	-55.1542	52.7138	18.411	-56.8963
0.432	47.5502	14.6142	-57.4718	0.0249	0.3672	38.2161	11.0243	-57.2229	56.8843	18.204	-57.7207
0.456	51.0827	16.8635	-57.2988	0.0124	0.3343	40.2675	13.1065	-57.1571	61.8979	20.6205	-57.4406
0.48	54.7356	17.1884	-59.2956	-0.024	0.3422	43.2998	13.1152	-59.5866	66.1714	21.2616	-59.0047
0.504	57.754	17.8534	-59.9367	-0.0861	0.3263	46.3757	14.0031	-60.9731	69.1324	21.7037	-58.9004
0.528	61.6013	18.2944	-60.3527	-0.1092	0.326	50.2151	14.4453	-61.67	72.9876	22.1436	-59.0354
0.552	66.5094	18.9756	-59.8308	-0.1441	0.4316	58.0361	15.0734	-61.1849	74.9828	22.8779	-58.4767
0.576	70.5736	19.7998	-59.4882	-0.2174	0.3927	62.8989	16.6206	-61.3228	78.2484	22.979	-57.6536
0.6	71.646	20.9684	-59.5199	-0.2241	0.5656	64.962	16.7256	-61.3243	78.3301	25.2111	-57.7155
0.624	75.883	23.0734	-59.0869	-0.2026	0.61	68.6152	17.9942	-60.9081	83.1509	28.1526	-57.2658
0.648	80.0313	23.4516	-59.5771	-0.2928	0.626	73.3697	18.6351	-62.0555	86.6929	28.268	-57.0986
0.672	79.5471	23.9393	-58.9883	-0.346	0.6086	73.3724	19.6367	-61.701	85.7218	28.2419	-56.2756
0.696	81.0315	24.5987	-58.7448	-0.4086	0.7065	75.5473	19.9179	-61.8665	86.5157	29.2796	-55.6231
0.72	83.2758	26.1897	-58.3019	-0.4425	0.7509	78.6244	21.8486	-61.317	87.9272	30.5308	-55.2868
0.744	84.4593	26.3261	-58.4195	-0.5426	0.8395	80.3119	21.7041	-62.1638	88.6067	30.9481	-54.6753
0.768	85.8285	27.6777	-58.4143	-0.5543	0.8874	82.1329	23.139	-62.0376	89.5241	32.2165	-54.7909
0.792	87.4729	29.0093	-57.9135	-0.5602	0.8441	83.4357	24.4682	-61.7245	91.5101	33.5504	-54.1025
0.816	86.8327	29.8322	-57.8529	-0.622	0.9869	83.774	25.2028	-61.8308	89.8915	34.4615	-53.8749
0.84	88.5714	30.1779	-57.929	-0.6054	0.9094	84.7342	25.2478	-62.2524	92.4087	35.108	-53.6055
0.864	90.3469	31.0793	-57.4769	-0.6039	0.9054	86.3999	26.0496	-61.8878	94.294	36.109	-53.0661
0.888	90.9277	31.1231	-58.1331	-0.5673	0.9749	87.1716	25.5836	-62.3976	94.6838	36.6626	-53.8685
0.912	91.383	31.7609	-58.2553	-0.6224	0.9743	88.1085	26.938	-62.4377	94.6574	36.5837	-54.073
0.936	91.4751	31.6431	-57.4269	-0.6786	0.9705	88.1953	26.852	-62.1086	94.7549	36.4342	-52.7451
0.96	91.5279	32.1974	-56.9194	-0.7486	0.8504	87.9029	28.0673	-62.0242	95.1529	36.3275	-51.8146
0.984	91.4716	32.4759	-57.5516	-0.9302	0.8745	88.5676	29.0022	-63.6258	94.3756	35.9496	-51.4775
1.008	92.3153	32.828	-58.0915	-0.9578	0.8835	89.4531	29.3406	-64.5051	95.1775	36.3154	-51.6779
1.032	91.9634	33.3562	-58.611	-0.7995	0.8554	88.4072	29.264	-64.1873	95.5196	37.4484	-53.0347
1.056	91.9859	33.3587	-59.4642	-0.8821	0.8522	88.6075	29.4961	-65.699	95.3643	37.2214	-53.2295
1.08	93.5	34.6102	-58.3859	-0.9879	0.9428	91.0496	31.2353	-64.7115	95.9504	37.9852	-52.0604
1.104	93.1237	35.0415	-58.7357	-0.9555	0.8443	90.6539	32.2622	-63.9955	95.5935	37.8208	-53.476
1.128	93.8636	35.9902	-59.0802	-0.9728	0.8344	91.764	33.6743	-63.6687	95.9632	38.3061	-54.4916
1.152	93.4748	34.6184	-60.6961	-0.9584	0.9594	91.3785	31.6278	-65.8953	95.5711	37.6091	-55.497
1.176	93.7763	35.0841	-61.4002	-0.917	0.7454	91.1545	32.6638	-66.0575	96.3982	37.5044	-56.7428
1.2	94.5536	35.4413	-62.1538	-0.892	0.8786	91.9892	32.348	-67.135	97.118	38.5346	-57.1727

Rock11

time	pos(x)	pos(y)	pos(z)	el	az	x1	y1	z1	x2	y2	z2
1.224	94.4394	35.4396	-63.5245	-0.958	1.1614	93.064	32.2698	-68.4387	95.8147	38.6094	-58.6104
1.248	94.6605	35.7285	-64.639	-0.8913	1.1209	92.8405	31.9601	-69.8193	96.4804	39.497	-59.4588
1.272	92.5848	36.3242	-64.6201	-0.952	1.056	90.7844	33.1418	-69.7552	94.3852	39.5066	-59.485
1.296	92.4097	35.7336	-66.886	-0.8624	1.0671	90.0237	31.4039	-72.6562	94.7958	40.0632	-61.1158
1.32	92.4623	35.9678	-67.6672	-0.8247	1.0666	90.2465	31.9519	-72.629	94.6781	39.9836	-62.7054
1.344	92.7599	36.8448	-67.873	-0.6821	1.001	89.8422	32.2903	-72.2662	95.6776	41.3992	-63.4798
1.368	92.5919	36.4384	-69.7661	-0.7001	0.9853	89.6514	32.0038	-74.2485	95.5325	40.873	-65.2837
1.392	92.9574	36.9804	-70.5422	-0.7255	1.091	90.8244	32.8816	-74.6402	95.0903	41.0792	-66.4442
1.416	92.4176	37.7148	-72.1348	-0.6449	1.269	90.8175	32.5753	-76.184	94.0177	42.8544	-68.0855
1.44	92.4007	38.4981	-73.5463	-0.4526	1.3807	91.1724	32.1149	-76.7074	93.6289	44.8813	-70.3852
1.464	93.1931	38.6633	-75.0544	-0.3697	1.3925	92.1022	32.6083	-77.4388	94.2841	44.7183	-72.67
1.488	93.9426	38.4582	-76.1191	-0.2158	1.366	92.7524	32.7278	-77.4019	95.1328	44.1885	-74.8362
1.512	93.4922	39.2421	-76.8618	-0.1225	1.2666	91.5112	32.932	-77.676	95.4731	45.5521	-76.0476
1.536	93.0315	38.0056	-78.67	-0.0752	1.3369	91.4784	31.4871	-79.1749	94.5846	44.5241	-78.1651
1.56	93.0499	38.3671	-80.26	-0.0394	1.3458	91.3472	30.9271	-80.5608	94.7526	45.8072	-79.9593
1.584	94.3508	38.7765	-81.4041	0.1402	1.3771	93.0668	32.232	-80.463	95.6348	45.321	-82.3453
1.608	94.1078	39.2467	-81.6142	0.1949	1.3757	92.802	32.6368	-80.2844	95.4137	45.8566	-82.944
1.632	95.2991	39.7178	-82.909	0.1514	1.4157	94.2513	33.0175	-81.8746	96.3468	46.4182	-83.9434
1.656	95.0161	38.9508	-84.7163	0.2589	1.4782	94.6666	33.0345	-83.1427	95.5656	44.8671	-86.29
1.68	96.0323	39.8091	-85.3236	0.4151	1.7596	96.7978	35.8025	-83.5261	95.2668	43.8156	-87.1212
1.704	95.4831	40.5576	-86.9702	0.344	1.7822	96.5399	35.6326	-85.1659	94.4264	45.4826	-88.7746
1.728	95.8661	40.9299	-88.0679	0.4563	1.7526	96.6456	36.69	-85.9518	95.0866	45.1698	-90.184
1.752	97.5189	41.8332	-88.9199	0.3859	1.488	97.1093	36.8983	-86.908	97.9284	46.7681	-90.9318
1.776	96.7168	41.829	-89.6079	0.5171	1.6216	96.9112	38.0069	-87.4313	96.5224	45.6511	-91.7845
1.8	98.2063	42.714	-90.3853	0.3502	1.5174	97.9692	38.2754	-88.7617	98.4434	47.1526	-92.009
1.824	98.7657	44.0049	-91.4112	0.3727	1.4623	98.2292	39.0787	-89.4738	99.3022	48.9311	-93.3486
1.848	99.0694	44.1424	-91.4471	0.2126	1.3379	97.8636	39.0581	-90.3191	100.2752	49.2267	-92.5751
1.872	99.8057	44.905	-92.4243	0.1962	1.1975	97.9679	40.2123	-91.4225	101.6436	49.5976	-93.426
1.896	100.8061	43.8179	-94.2283	-0.1231	0.9557	96.5109	37.7382	-95.1495	105.1012	49.8976	-93.3071
1.92	101.8281	44.8192	-95.0037	-0.1968	0.986	98.2912	39.477	-96.2812	105.3651	50.1615	-93.7261
1.944	102.5118	45.6121	-95.8735	-0.183	1.0472	99.2829	40.0198	-97.0684	105.7407	51.2043	-94.6786
1.968	101.8187	46.4763	-96.511	-0.2568	1.1847	99.5545	40.9068	-98.0899	104.083	52.0457	-94.9322
1.992	101.553	46.7406	-96.9808	-0.3097	1.2215	99.6133	41.4143	-98.7948	103.4927	52.0668	-95.1667
2.016	101.795	47.5169	-99.4016	-0.2954	1.049	98.8367	42.372	-101.2077	104.7532	52.6619	-97.5956
2.04	102.1373	48.007	-100.4574	-0.4037	1.0421	99.2533	43.0702	-102.8994	105.0213	52.9437	-98.0154
2.064	103.2672	49.4935	-100.7468	-0.3728	1.0449	99.6444	43.2518	-103.5692	106.8901	55.7352	-97.9243
2.088	102.9703	49.9986	-100.8675	-0.5272	0.9655	99.1954	44.5432	-104.7299	106.7453	55.454	-97.0052
2.112	103.4785	50.991	-101.8543	-0.5326	0.9672	99.8531	45.7325	-105.6185	107.1038	56.2495	-98.0901
2.136	103.6349	51.1146	-102.9949	-0.64	0.9706	100.2008	46.097	-107.5216	107.069	56.1322	-98.4682
2.16	103.7161	51.2931	-103.2582	-0.7108	0.9712	100.3284	46.3366	-108.4264	107.1038	56.2495	-98.0901
2.184	103.3299	51.6381	-105.1809	-0.568	0.9222	98.769	45.6205	-109.9994	107.8907	57.6558	-100.3625
2.208	102.8485	50.962	-105.1794	-0.5263	0.8911	98.4095	45.4697	-109.2818	107.2876	56.4542	-101.077
2.232	102.6743	51.961	-105.6486	-0.5881	0.7887	98.1776	47.4345	-109.903	107.1711	56.4875	-101.3942
2.256	103.577	52.3995	-106.3753	-0.4483	0.7435	98.1776	47.4345	-109.903	108.9764	57.3646	-102.8475
2.28	103.5327	52.8145	-107.4142	-0.5565	0.3813	96.4123	49.9597	-112.1861	110.6532	55.6693	-102.6423
2.304	104.6944	54.0156	-107.755	-0.5635	0.3608	96.8198	51.044	-113.0725	112.5691	56.9872	-102.4375
2.328	103.8518	54.2568	-109.0225	-0.5241	0.3079	94.8676	51.3993	-114.4715	112.8361	57.1142	-103.5735
2.352	104.2974	54.2466	-109.9735	-0.5612	0.2109	96.1788	52.5088	-115.1927	112.4161	55.9844	-104.7544
2.376	104.9712	54.2771	-111.5851	-0.5167	0.2037	97.3297	52.6986	-116.019	112.6128	55.8557	-107.1512
2.4	103.9786	53.9115	-114.0192	-0.4572	0.2966	94.7456	51.0897	-118.7686	113.2116	56.7334	-109.2698
2.424	104.4336	54.6509	-114.5781	-0.4141	0.2466	94.3489	52.1123	-119.1486	114.5183	57.1894	-110.0076
2.448	103.1869	55.095	-116.0397	-0.418	0.2311	93.0763	52.7161	-120.6539	113.2975	57.4738	-111.4256
2.472	104.616	56.1316	-117.4801	-0.3452	0.1863	94.183	54.1656	-121.2976	115.0489	58.0976	-113.6626
2.496	103.5038	55.3271	-119.1895	-0.3169	0.2982	92.9479	52.0824	-122.8115	114.0597	58.5719	-115.5676
2.52	104.2919	56.3767	-120.3884	-0.3175	0.2621	94.2588	53.6852	-123.8018	114.3251	59.0681	-116.975
2.544	104.3699	55.934	-121.8604	-0.2844	0.281	93.3945	52.7666	-125.1998	115.3454	59.1015	-118.521
2.568	106.7103	57.3018	-123.1825	-0.1618	0.2685	95.8976	54.3262	-125.0129	117.523	60.2774	-121.3521
2.592	105.539	56.5583	-125.8183	-0.1697	0.3377	95.042	52.8722	-127.7243	116.0361	60.2444	-123.9122
2.616	105.7851	56.1652	-126.4289	-0.1049	0.343	93.8013	51.885	-127.7681	117.769	60.4453	-125.0896
2.64	105.8701	57.2192	-128.1755	0.0221	0.331	93.0423	52.8106	-127.8755	118.698	61.6278	-128.4756
2.664	103.8266	56.3969	-128.7062	0.061	0.3638	89.0726	50.78	-127.7414	118.5805	62.0138	-129.6711
2.688	104.8149	56.9984	-129.7865	0.1265	0.4182	91.8071	51.2168	-127.9767	117.8228	62.78	-131.5963
2.712	106.6065	56.8509	-131.5665	0.1661	0.4251	94.4852	51.3631	-129.3357	118.7277	62.3386	-133.7973
2.736	107.6598	57.6398	-134.4473	0.1272	0.3154	95.7186	53.7431	-132.841	119.601	61.5365	-136.0536
2.76	108.2771	58.498	-134.8075	0.146	0.2493	93.7244	54.7923	-132.5997	122.8297	62.2036	-137.0153
2.784	109.4818	59.1262	-135.7547	0.1208	0.3873	95.496	53.4213	-133.9214	123.4677	64.8311	-137.588

Rock11

time	pos(x)	pos(y)	pos(z)	el	az	x1	y1	z1	x2	y2	z2
2.808	110.4667	58.8601	-137.3472	0.1235	0.2452	96.6738	55.4086	-135.5828	124.2596	62.3117	-139.1116
2.832	111.6352	59.6331	-139.2954	0.1475	0.2198	97.2172	56.4123	-137.0997	126.0532	62.854	-141.4911
2.856	112.364	58.6756	-139.299	0.1136	0.2157	98.0372	55.536	-137.6262	126.6908	61.8152	-140.9718
2.88	113.4588	61.8513	-141.0099	0.0802	0.1658	100.3443	59.6568	-139.9412	126.5732	64.0459	-142.0786
2.904	114.0698	62.28	-142.4296	0.0616	0.1205	99.5558	60.5232	-141.5281	128.5838	64.0369	-143.331
2.928	116.0367	63.1585	-143.6149	0.0939	0.1148	103.3363	61.6935	-142.4115	128.7371	64.6235	-144.8183
2.952	116.9227	63.2547	-144.6584	0.0274	0.0997	103.8116	61.9437	-144.2969	130.0339	64.5656	-145.0199
2.976	118.7164	64.1358	-145.499	0.0169	0.0427	105.8574	63.5867	-145.2809	131.5753	64.6849	-145.7171
3	118.5669	63.381	-146.7607	-0.0077	0.0691	105.1989	62.4562	-146.8635	131.935	64.3058	-146.6579
3.024	120.0757	62.5747	-147.594	-0.0401	0.1068	107.0621	61.1801	-148.1194	133.0894	63.9693	-147.0686
3.048	119.3868	63.3213	-148.7871	-0.1394	0.0879	104.0653	61.9705	-150.9453	134.7083	64.672	-146.6288
3.072	121.0935	63.6494	-149.8186	-0.2052	0.0116	108.8562	63.5075	-152.3658	133.3309	63.7913	-147.2714
3.096	121.9303	64.8853	-150.0116	-0.2523	-0.007	109.4096	64.9725	-153.2392	134.4509	64.7981	-146.7841
3.12	123.1654	64.1786	-152.2399	-0.2768	-0.0353	111.3169	64.5965	-155.6085	135.0139	63.7608	-148.8714
3.144	123.5	64.9385	-153.1256	-0.3386	-0.0601	111.2846	65.6741	-157.4353	135.7155	64.2028	-148.816
3.168	126.0671	64.7785	-153.942	-0.4129	-0.0182	114.9972	64.9802	-158.793	137.137	64.5769	-149.091
3.192	124.099	64.9098	-156.1734	-0.4654	-0.0928	113.276	65.9172	-161.6326	134.9219	63.9024	-150.7142
3.216	125.5342	64.4808	-156.1512	-0.4928	-0.1318	115.6871	65.7859	-161.4852	135.3813	63.1756	-150.8173
3.24	125.5482	67.328	-156.9307	-0.5602	-0.3104	116.5356	70.2186	-162.8673	134.5609	64.4375	-150.9942
3.264	126.5225	65.8778	-158.5887	-0.5326	-0.2582	117.9874	68.1314	-163.7913	135.0576	63.6242	-153.3861
3.288	127.51	66.0332	-158.9202	-0.5509	-0.3246	117.9168	69.2609	-165.1383	137.1032	62.8055	-152.702
3.312	128.1173	65.9344	-160.3233	-0.5315	-0.3553	118.182	69.6208	-166.5536	138.0527	62.248	-154.093
3.336	128.7595	65.9221	-161.4006	-0.5802	-0.4479	118.8939	70.6621	-168.5752	138.625	61.182	-154.226
3.36	129.3792	66.7061	-162.2242	-0.6146	-0.5236	120.9565	71.5693	-169.0889	137.8018	61.8429	-155.3595
3.384	128.0414	66.7393	-162.7395	-0.5711	-0.5975	120.9838	71.5415	-168.2242	135.0991	61.9372	-157.2547
3.408	129.7836	67.0932	-164.0777	-0.5158	-0.5919	122.6999	71.8555	-168.918	136.8673	62.331	-159.2374
3.432	130.7781	67.5428	-166.981	-0.4716	-0.6288	123.4149	72.8974	-171.6243	138.1413	62.1882	-162.3378
3.456	130.4356	66.9969	-167.2151	-0.4566	-0.6888	124.3091	72.0407	-171.1137	136.5621	61.953	-163.3165
3.48	129.7971	67.0839	-169.7745	-0.4488	-0.5955	122.7271	71.8743	-173.887	136.8671	62.2935	-165.6619
3.504	130.9074	67.472	-170.3647	-0.5154	-0.7295	125.7977	72.0407	-174.2474	136.0172	62.9033	-166.482
3.528	132.1072	67.2014	-172.6177	-0.3134	-0.5864	125.4895	71.5982	-175.1928	138.725	62.8047	-170.0426
3.552	131.5598	68.3933	-173.81	-0.2692	-0.6883	125.3566	73.4956	-176.0257	137.7631	63.2911	-171.5944
3.576	131.4849	68.2546	-175.5237	-0.218	-0.7208	125.4316	73.5726	-177.3086	137.5382	62.9366	-173.7387
3.6	131.8292	68.6933	-177.0167	-0.1318	-0.5122	123.7179	73.2537	-178.2503	139.9405	64.1329	-175.7831
3.624	133.5636	67.9773	-177.9425	-0.0978	-0.5278	127.0957	71.748	-178.6773	140.0315	64.2065	-177.2076
3.648	131.8347	69.5225	-179.3246	-0.0444	-0.4399	123.7878	73.3101	-179.7198	139.8815	65.735	-178.9294
3.672	133.1486	68.3504	-181.8685	0.1504	-0.4396	124.6403	72.3521	-180.444	141.6568	64.3486	-183.293
3.696	133.4307	68.7231	-183.6855	0.0966	-0.3907	123.5147	72.8075	-182.6466	143.3467	64.6386	-184.7245
3.72	134.0955	68.6222	-184.7651	0.2094	-0.4586	125.1542	73.0362	-182.6455	143.0368	64.2082	-186.8846
3.744	133.0665	69.3167	-186.5778	0.1397	-0.4456	121.8563	74.6714	-184.8302	144.2767	63.9621	-188.3253
3.768	135.1965	68.1936	-187.8759	0.1377	-0.4709	125.3466	73.2077	-186.3437	145.0464	63.1795	-189.4081
3.792	135.0954	67.9127	-188.9444	0.2574	-0.4572	126.1911	72.2934	-186.332	143.9997	63.532	-191.5568
3.816	134.8845	67.7096	-190.0294	0.2609	-0.4642	124.987	72.6658	-187.074	144.782	62.7535	-192.9849
3.84	134.7724	67.4966	-192.0301	0.2387	-0.6016	126.7557	72.9998	-189.6637	142.7891	61.9934	-194.3966
3.864	134.8626	67.4716	-192.9221	0.351	-0.4581	125.95	71.866	-189.2835	143.7751	63.0773	-196.5607
3.888	131.5812	66.0871	-193.8031	0.3817	-0.5392	122.695	71.4044	-189.6462	140.4675	60.7698	-197.9601
3.912	133.0406	66.0729	-194.7157	0.3646	-0.5109	124.0009	71.1399	-190.7602	142.0803	61.0059	-198.6711
3.936	132.8064	66.4987	-195.1151	0.4096	-0.5746	126.5393	70.5565	-191.8736	139.0736	62.4409	-198.3566
3.96	133.8419	65.278	-196.8749	0.2701	-0.4932	123.7553	70.6999	-193.705	143.9285	59.8561	-200.0449
3.984	129.9964	66.9135	-197.2416	0.2328	-0.4545	117.8622	72.8426	-194.0388	142.1306	60.9844	-200.4443
4.008	138.9853	64.403	-200.39	-0.0812	-0.6922	132.2337	70	-201.1038	145.737	58.8061	-199.6762
4.032	138.7822	65.7425	-201.542	-0.2102	-0.939	134.733	71.2747	-203.0047	142.8313	60.2104	-200.0793
4.056	141.0013	64.8925	-203.1627	-0.3425	-0.8982	136.8534	70.1006	-205.5363	145.1492	59.6843	-200.789
4.08	137.6679	64.138	-203.1252	-0.4314	-0.9157	133.347	69.7623	-206.3904	141.9888	58.5137	-199.8601
4.104	138.1929	64.6814	-204.9658	-0.5452	-0.9689	134.4448	70.1382	-208.9807	141.941	59.2246	-200.9508
4.128	138.7427	63.2786	-205.8998	-0.7831	-1.0381	136.0249	67.8883	-211.2267	141.4605	58.6688	-200.5728
4.152	138.5376	63.6308	-206.5448	-0.792	-0.9464	135.4114	67.9698	-211.9633	141.6638	59.2919	-201.1263
4.176	138.815	63.8992	-207.9243	-0.8666	-1.0844	136.4756	68.3237	-213.8164	141.1543	59.4747	-202.0321
4.2	139.0149	63.2627	-208.7153	-0.903	-1.3213	137.7747	68.1289	-215.083	140.255	58.3964	-202.3476
4.224	139.8663	63.9592	-210.6435	-0.9273	-1.4992	139.517	68.8263	-217.1492	140.2155	59.092	-204.1378
4.248	140.3687	64.025	-211.2637	-1.0062	-1.6322	140.6313	68.2936	-218.0157	140.1061	59.7564	-204.5117
4.272	140.7031	63.2773	-211.6533	-0.999	-2.0248	142.5695	67.1022	-218.2666	138.8367	59.4524	-205.0399
4.296	141.2708	63.4313	-213.8661	-0.7949	-2.1972	145.2681	68.9552	-220.8153	137.2735	57.9075	-206.9168
4.32	141.6429	64.0201	-215.0988	-0.7376	-2.2923	146.7972	69.8795	-222.1898	136.4887	58.1607	-208.0078
4.344	140.8672	62.5837	-215.7791	-0.7411	-2.3926	146.7307	68.0353	-223.1058	135.0037	57.1321	-208.4525
4.368	140.6132	62.9652	-218.2163	-0.6525	-2.5432	147.6509	67.7637	-224.7248	133.5755	58.1667	-211.7077

Rock11

time	pos(x)	pos(y)	pos(z)	el	az	x1	y1	z1	x2	y2	z2
4.392	141.5487	62.9625	-219.9338	-0.6863	-2.6497	148.0962	68.1704	-226.7874	135.0012	57.7546	-213.0802
4.416	141.0902	63.4089	-221.7485	-0.8207	-2.6104	146.4671	66.5676	-228.4406	135.7133	60.2501	-215.0564
4.44	141.02	62.3444	-223.077	-0.6266	-2.6685	148.1911	66.0146	-228.9087	133.8489	58.6741	-217.2452
4.464	142.329	63.6475	-224.3785	-0.5929	-2.6541	149.9855	67.7069	-230.2171	134.6725	59.5881	-218.5399
4.488	142.1815	64.165	-225.8829	-0.4417	-2.6454	151.2241	69.06	-230.7453	133.1389	59.2699	-221.0205
4.512	143.1534	64.9725	-228.2046	-0.4198	-2.7452	152.1163	68.7242	-232.5412	134.1905	61.2208	-223.8681
4.536	144.9774	65.6311	-229.3731	-0.3624	-2.7836	155.2866	69.4874	-233.5464	134.6683	61.7748	-225.1998
4.56	144.8581	64.8693	-230.5616	-0.334	-2.743	157.414	70.1565	-235.2891	132.3022	59.5822	-225.8341
4.584	143.9101	64.3188	-232.8496	-0.2872	-2.7457	154.4323	68.7166	-236.218	133.3879	59.9209	-229.4811
4.608	145.6111	62.438	-234.1195	-0.1453	-2.818	158.4848	66.7549	-236.1059	132.7374	58.121	-232.1332
4.632	148.2962	63.0152	-234.8699	0.0136	-2.865	163.1044	67.2181	-234.6603	133.488	58.8123	-235.0795
4.656	149.1762	62.3447	-236.4233	0.0554	-2.8908	163.5817	66.0351	-235.5988	134.7707	58.6543	-237.2479
4.68	146.0391	61.8074	-237.9976	-0.0132	-2.8418	159.4033	65.9378	-238.1825	132.6748	57.6769	-237.8128
4.704	148.4615	62.8351	-240.6839	0.0994	-2.8012	162.5914	67.8389	-239.1892	134.3316	57.8312	-242.1786
4.728	146.8545	61.8024	-242.1883	0.1523	-2.8662	158.8606	65.1944	-240.2731	134.8484	58.4104	-244.1036
4.752	145.2466	61.5526	-242.173	0.0657	-2.9528	159.5109	64.2783	-241.2179	130.9824	58.8269	-243.1281
4.776	146.6061	62.0218	-245.309	0.0904	-2.8533	159.7427	65.9178	-244.0665	133.4696	58.1259	-246.5514
4.8	145.4426	63.029	-247.1623	0.1414	-2.9085	158.7478	66.188	-245.2161	132.1375	59.87	-249.1084
4.824	140.0609	60.7397	-248.7656	0.1354	-2.8353	151.1974	64.2616	-247.1747	128.9244	57.2177	-250.3564
4.848	141.6719	61.8029	-249.3321	0.0434	-2.7581	151.1568	65.6297	-248.8881	132.187	57.976	-249.776
4.872	139.5708	61.75	-250.4464	0.0401	-2.831	150.899	65.3856	-249.9695	128.2426	58.1144	-250.9232
4.896	139.0911	61.0818	-251.4292	-0.0112	-2.894	151.4583	64.208	-251.5722	126.7238	57.9557	-251.2862
4.92	138.3839	61.0828	-252.7464	-0.038	-2.8153	149.1132	64.714	-253.1773	127.6546	57.4517	-252.3154
4.944	138.9529	61.61	-255.2164	0.0206	-2.8963	150.3763	64.4697	-254.9739	127.5296	58.7503	-255.4589
4.968	137.0108	60.9764	-256.4278	-0.0489	-2.9265	148.1876	63.4179	-256.9875	125.834	58.535	-255.868
4.992	136.289	60.8847	-256.3998	-0.142	-2.8497	145.699	63.7117	-257.8045	126.8789	58.0577	-254.995
5.016	135.383	59.6408	-257.9771	-0.2219	-2.9712	146.9741	61.6358	-260.6303	123.7919	57.6459	-255.3238
5.04	135.5391	59.5965	-259.403	-0.1731	-2.8858	148.0122	62.8588	-261.6568	123.066	56.3341	-257.1493
5.064	133.8506	58.2	-260.7141	-0.2006	-2.9588	146.2464	60.4915	-263.2775	121.4548	55.9085	-258.1507
5.088	131.9545	58.4225	-261.9075	-0.271	-2.9593	143.554	60.5611	-265.1841	120.3549	56.2838	-258.631
5.112	131.1909	59.191	-262.8301	-0.2767	-2.9441	141.2845	61.2112	-265.7536	121.0972	57.1708	-259.9067
5.136	129.073	59.114	-263.0308	-0.3205	-3.0035	142.5387	60.985	-267.5442	115.6074	57.243	-258.5175
5.16	131.8806	58.1606	-265.1299	-0.2954	-3.0566	145.4516	59.3164	-269.2745	118.3096	57.0048	-260.9853
5.184	132.2469	56.8418	-265.5023	-0.4554	-3.0706	142.7425	57.588	-270.6559	121.7512	56.0957	-260.3487
5.208	130.0908	57.6663	-266.6314	-0.4831	3.0726	142.2281	56.827	-273.0134	117.9535	58.5055	-260.2495
5.232	130.7351	56.7272	-267.4542	-0.5173	2.973	140.7507	55.0229	-273.2345	120.7196	58.4314	-261.674
5.256	131.1062	57.0955	-269.5518	-0.4785	2.923	140.7538	54.9525	-274.6778	121.4585	59.2384	-264.4257
5.28	129.398	55.6087	-270.6289	-0.5836	2.9253	137.1847	53.8973	-275.8933	121.6114	57.32	-265.3644
5.304	130.36	55.0583	-271.1472	-0.5178	2.8581	138.8413	52.5878	-276.1788	121.8786	57.5288	-266.1156
5.328	129.311	56.5021	-272.3397	-0.6106	2.699	136.4973	53.0963	-277.9053	122.1246	59.9079	-266.7741
5.352	131.8117	55.1072	-274.5791	-0.4959	2.7296	140.5601	51.284	-279.7435	123.0633	58.9304	-269.4146
5.376	132.1617	53.7474	-275.6147	-0.4347	2.699	140.6031	49.7464	-279.9521	123.7204	57.7483	-271.2773
5.4	131.7219	53.8007	-277.2619	-0.4265	2.5995	138.2183	49.888	-280.7077	125.2254	57.7135	-273.816
5.424	129.2646	54.0692	-278.2968	-0.436	2.6097	135.9135	50.1565	-281.891	122.6157	57.9819	-274.7026
5.448	129.8385	53.9428	-279.1188	-0.2849	2.6084	137.8569	49.2102	-281.8459	121.8201	58.6754	-276.3917
5.472	132.7074	53.8804	-280.8237	-0.2829	2.6049	140.6554	49.1516	-283.5123	124.7594	58.6092	-278.1351
5.496	134.049	51.9898	-282.5184	-0.2686	2.5965	141.7562	47.3166	-284.9993	126.3418	56.6631	-280.0375
5.52	130.787	53.1662	-283.2672	-0.0522	2.6611	139.8031	48.4669	-283.7986	121.7709	57.8654	-282.7358
5.544	130.6549	52.8813	-284.0612	-0.0294	2.6537	139.6156	48.126	-284.3595	121.6941	57.6365	-283.7629
5.568	131.7568	53.2101	-285.8325	0.0433	2.6352	139.1479	49.1112	-285.466	124.3657	57.309	-286.199
5.592	132.0736	52.6972	-286.9332	0.0149	2.6981	140.2508	48.8127	-286.7982	123.8964	56.5817	-287.0683
5.616	132.0008	53.4004	-288.3005	0.1217	2.7629	141.1314	49.7674	-287.0988	122.8702	57.0334	-289.5021
5.64	132.2194	52.4584	-290.686	0.1294	2.8002	139.9316	49.7184	-289.6213	124.5072	55.1984	-291.7506
5.664	131.7727	52.5574	-291.6682	0.3332	2.9892	138.6099	51.5071	-289.2743	124.9356	53.6077	-294.062
5.688	133.1483	51.5335	-293.8019	0.5259	2.9	139.8804	49.8746	-289.7775	126.4162	53.1924	-297.8263
5.712	134.2349	52.7386	-295.8657	0.4241	2.8968	141.0969	51.0243	-292.6726	127.3729	54.4529	-299.0589
5.736	132.8522	52.2742	-298.3783	0.4673	2.8547	139.491	50.3156	-294.8861	126.2134	54.2327	-301.8705
5.76	134.4594	53.3269	-300.4197	0.6283	2.6653	139.8193	50.5615	-296.0376	129.0994	56.0923	-304.8017
5.784	135.6623	53.3055	-300.6239	0.4848	2.8609	143.0188	51.1845	-296.5912	128.3057	55.4265	-304.6567
5.808	131.4482	53.4826	-301.9462	0.5815	2.6846	135.6572	51.4131	-298.863	127.2391	55.5521	-305.0294
5.832	131.3184	53.3702	-303.0391	0.4484	2.7477	136.781	51.0996	-300.1932	125.8558	55.6408	-305.885
5.856	134.0247	54.1083	-304.7369	0.6087	2.0297	136.0539	50.0013	-301.5438	131.9955	58.2153	-307.93
5.88	132.6286	54.5123	-306.5482	0.5668	1.0662	130.9911	51.5471	-304.3923	134.266	57.4775	-308.7042
5.904	133.3879	54.5345	-308.0293	0.5045	1.2152	132.2204	51.3911	-306.1776	134.5555	57.6779	-309.8809
5.928	133.1027	55.7088	-308.8346	0.4622	1.1422	131.1773	51.4947	-306.5262	135.0281	59.9229	-311.143
5.952	132.9859	54.6959	-308.7811	0.3539	1.3633	132.2111	51.0146	-307.3913	133.7607	58.3772	-310.171

Rock11											
time	pos(x)	pos(y)	pos(z)	el	az	x1	y1	z1	x2	y2	z2
5.976	133.8693	55.411	-312.3912	0.3915	1.0401	131.8394	51.9517	-310.7357	135.8993	58.8703	-314.0468
6	132.7169	54.7244	-313.0306	0.4429	1.1424	130.8409	50.6168	-310.8887	134.5928	58.8319	-315.1724
6.024	133.82	57.1787	-313.7593	0.4297	1.0423	131.9691	54.0085	-312.0772	135.671	60.3488	-315.4414

Rockan											
time	pos(x)	pos(y)	pos(z)	el	az	x1	y1	z1	x2	y2	z2
0	0	0	0	1.0764	0.8234	-1.8071	-1.9501	4.9322	1.8071	1.9501	-4.9322
0.024	0.9634	0.9464	-5.5611	1.1005	0.7943	-0.8917	-0.9422	-0.3535	2.8185	2.835	-10.7687
0.048	2.5544	1.5154	-10.9851	1.0569	0.7591	0.4265	-0.5033	-5.7894	4.6823	3.5341	-16.1808
0.072	3.7981	2.3381	-16.1581	1.1151	0.5811	1.4082	0.7685	-10.324	6.188	3.9078	-21.9922
0.096	5.4663	4.4386	-18.7085	0.9279	0.6532	2.0187	1.8	-12.9132	8.9139	7.0772	-24.5038
0.12	6.4642	4.6492	-23.3821	1.001	0.4883	2.512	2.55	-16.3976	10.4164	6.7485	-30.3666
0.144	8.97	6.5711	-26.5961	0.9478	0.4229	4.4365	4.5308	-19.6765	13.5035	8.6114	-33.5157
0.168	11.1151	7.4724	-31.2786	0.7838	0.4587	6.1387	5.0152	-25.7463	16.0914	9.9296	-36.811
0.192	12.6428	9.04	-34.3999	0.7254	0.5124	7.6639	6.239	-29.3348	17.6217	11.8409	-39.465
0.216	14.7643	9.3258	-38.6291	0.5809	0.5333	8.6343	5.7066	-33.9565	20.8944	12.9449	-43.3018
0.24	17.472	10.422	-41.9314	0.5032	0.6286	11.539	6.1091	-37.8936	23.4049	14.7348	-45.9692
0.264	19.2729	11.3304	-45.7492	0.4748	0.535	13.1423	7.6972	-42.0866	25.4034	14.9635	-49.4118
0.288	22.2879	12.9293	-47.8159	0.3826	0.5564	15.4025	8.647	-44.5525	29.1733	17.2117	-51.0793
0.312	27.0941	15.2637	-51.8793	0.2606	0.5324	20.9634	11.6522	-49.9816	33.2248	18.8752	-53.777
0.336	28.908	15.5661	-53.9329	-0.142	0.7667	25.024	11.8243	-54.7038	32.792	19.3079	-53.162
0.36	32.856	17.1304	-55.5231	-0.3221	0.8017	29.4245	13.5852	-57.1697	36.2876	20.6756	-53.8765
0.384	34.0593	17.8855	-57.0028	-0.6366	1.1999	32.307	13.3794	-60.5769	35.8116	22.3916	-53.4286
0.408	35.1474	18.1427	-60.3445	-0.6017	1.4162	34.3641	13.1171	-63.837	35.9307	23.1682	-56.8521
0.432	37.8104	18.6669	-62.2117	-0.7198	1.3172	36.406	13.2479	-67.1197	39.2149	24.0859	-57.3037
0.456	39.6453	20.1209	-64.1478	-0.8911	1.2063	37.997	15.8006	-69.8693	41.2935	24.4413	-58.4262
0.48	41.9766	20.8928	-66.0976	-0.8888	1.1907	39.9583	15.8414	-72.797	43.995	25.9442	-59.3982
0.504	42.8116	22.127	-68.8254	-0.8931	1.0951	40.5018	17.6435	-75.0911	45.1214	26.6105	-62.5597
0.528	43.2361	23.6555	-70.8651	-0.9329	1.0737	41.0664	19.6568	-77.0028	45.4058	27.6543	-64.7274
0.552	46.1066	24.052	-74.1306	-0.961	0.9624	43.2533	19.9557	-81.2767	48.9598	28.1482	-66.9846
0.576	46.4216	25.472	-77.1837	-1.0715	1.1585	44.84	21.8555	-84.422	48.0032	29.0886	-69.9455
0.6	47.6332	25.713	-79.667	-1.2143	1.489	47.4012	22.8814	-87.297	47.8652	28.5445	-72.037
0.624	49.4259	26.2226	-81.4951	-1.1565	1.6485	49.6745	23.0307	-88.7765	49.1772	29.4145	-74.2137
0.648	48.6188	27.1352	-84.0376	-1.1818	2.0991	50.1369	24.5341	-91.386	47.1006	29.7363	-76.6892
0.672	49.1606	27.6578	-86.233	-1.2432	2.4379	51.5298	25.6473	-95.3767	46.7913	29.6683	-77.0893
0.696	49.7485	28.9194	-88.735	-1.3031	2.3596	51.5708	27.1093	-98.0992	47.9261	30.7295	-79.3708
0.72	50.329	28.4854	-91.3029	-1.2544	2.3922	52.6615	26.315	-101.0342	47.9964	30.6559	-81.5716
0.744	51.1025	29.4934	-94.4117	-1.3206	2.328	52.7696	27.7294	-103.9076	49.4355	31.2574	-84.9158
0.768	51.0603	30.3085	-96.679	-1.3173	2.508	53.0343	28.8582	-106.1352	49.0862	31.7589	-87.2227
0.792	51.8131	31.4219	-99.389	-1.4258	2.3351	52.7484	30.4463	-108.6408	50.8779	32.3974	-90.1373
0.816	52.6037	31.8106	-101.9898	-1.3614	2.8402	54.4412	31.2395	-111.0441	50.7663	32.3817	-92.9356
0.84	52.4593	32.355	-105.0669	-1.421	2.6308	53.6768	31.6727	-114.3162	51.2418	33.0373	-95.8177
0.864	52.9697	32.6125	-108.0668	-1.3279	2.5798	54.7469	31.494	-116.5392	51.1926	33.731	-99.5944
0.888	53.5791	33.2588	-111.0299	-1.3609	2.5348	55.2267	32.115	-120.4445	51.9315	34.4025	-101.6153
0.912	53.6992	33.529	-113.6344	-1.3227	2.5946	55.6279	32.3544	-122.5493	51.7706	34.7036	-104.7194
0.936	53.9177	33.5301	-116.8308	-1.2815	2.5171	56.005	32.0256	-125.4763	51.8304	35.0346	-108.1852
0.96	55.5979	34.7482	-120.1047	-1.204	2.9171	58.7996	34.0173	-128.6526	52.3962	35.4792	-111.5567
0.984	55.0485	34.6536	-122.7727	-1.144	2.7178	58.9161	32.9089	-132.1025	51.181	36.3983	-113.4429
1.008	55.7497	35.178	-126.0384	-1.1098	2.7711	59.7547	33.6225	-134.6887	51.7446	36.7335	-117.3882
1.032	56.2906	35.3599	-129.1621	-0.9505	2.7091	61.7228	32.8523	-137.5373	50.8584	37.8675	-120.7868
1.056	57.8305	35.9493	-131.9276	-0.8913	2.7732	64.0628	33.5437	-140.1965	51.5981	38.3548	-123.6587
1.08	60.0182	36.0559	-134.4851	-0.7328	2.8012	67.6937	33.3376	-141.8134	52.3426	38.7742	-127.1568
1.104	61.0601	35.6763	-137.6922	-0.6083	2.7804	69.1012	32.6382	-143.6784	53.0189	38.7145	-131.7059
1.128	62.3715	35.5394	-139.5766	-0.4677	2.8682	71.8537	32.8809	-144.5501	52.8893	38.1979	-134.6032
1.152	64.6359	35.7237	-141.2402	-0.1995	2.9362	75.2872	33.5048	-143.4403	53.9846	37.9425	-139.04
1.176	64.8134	36.0985	-143.1788	-0.1375	2.8858	72.9481	33.9714	-144.3421	56.6786	38.2255	-142.0155
1.2	68.2523	35.7104	-145.2998	0.0734	2.834	79.0754	32.2718	-144.4652	57.4293	39.1489	-146.1343
1.224	68.5471	35.873	-147.3294	0.3685	2.8447	76.2861	33.5058	-144.2042	60.8081	38.2403	-150.4547
1.248	71.0259	34.9406	-147.9645	0.5025	2.7877	76.9495	32.752	-144.4944	65.1022	37.1292	-151.4347
1.272	72.5529	34.3358	-148.9447	0.6843	2.7664	77.8762	32.2391	-144.2777	67.2297	36.4326	-153.6117
1.296	72.7287	34.8299	-150.9358	0.7498	2.583	77.6143	31.7767	-145.5704	67.8431	37.8831	-156.3011
1.32	72.1578	34.779	-152.0248	0.7601	2.5343	76.4269	31.8125	-147.0827	67.8887	37.7456	-156.9668
1.344	74.2033	33.9424	-152.5706	1.1016	2.2779	76.3613	31.4168	-146.0176	72.0452	36.468	-159.1236
1.368	73.8948	34.7139	-155.5224	0.9107	2.4638	77.5723	31.7534	-149.4411	70.2174	37.6744	-161.6038
1.392	73.9708	34.7252	-156.2082	1.0923	2.1071	75.4897	32.1698	-150.477	72.4519	37.2806	-161.9394

Rock12

time	pos(x)	pos(y)	pos(z)	el	az	x1	y1	z1	x2	y2	z2
1.416	73.5584	33.9983	-158.1662	1.0058	2.2923	76.0841	31.1273	-152.1337	71.0326	36.8694	-164.1988
1.44	74.3979	34.5194	-160.9677	1.0037	2.3027	77.3192	31.2675	-154.1033	71.4767	37.7713	-167.832
1.464	73.6719	34.2003	-161.5449	1.0359	2.1662	75.9484	30.8393	-154.6934	71.3953	37.5612	-168.3964
1.488	74.2919	34.1972	-162.6019	0.9933	2.3671	77.3458	31.2089	-156.045	71.2379	37.1854	-169.1587
1.512	73.8711	34.6964	-165.7938	0.8998	2.5018	78.497	31.2539	-158.5302	69.2452	38.139	-173.0575
1.536	73.7266	35.0001	-167.2418	0.9354	2.2535	77.3637	30.5269	-159.4235	70.0894	39.4734	-175.0601
1.56	73.536	34.8135	-169.2745	0.9674	2.27	76.9497	30.7544	-161.5787	70.1224	38.8725	-176.9704
1.584	72.9115	35.2787	-170.9626	0.9532	2.3137	76.4666	31.4077	-163.5627	69.3565	39.1496	-178.3624
1.608	72.0094	35.2627	-173.3729	0.9495	2.3016	75.5377	31.3266	-165.9883	68.481	39.1988	-180.7576
1.632	73.2683	35.5519	-175.507	1.011	2.0221	75.1577	31.6535	-168.5939	71.3789	39.4503	-182.4202
1.656	72.2821	36.8481	-178.084	0.906	1.744	73.2481	31.3267	-170.9324	71.3161	42.3695	-185.2356
1.68	72.5499	37.1806	-180.2164	0.8946	1.4474	71.9117	32.036	-173.7552	73.1881	42.3252	-186.6775
1.704	70.3784	38.5202	-182.7785	0.8599	1.4996	70.0116	33.3788	-176.7924	70.7452	43.6616	-188.7645
1.728	69.5119	39.2256	-184.6115	0.6669	1.353	67.9632	32.2269	-178.9685	71.0605	46.2242	-190.2545
1.752	68.9259	41.1428	-186.0951	0.7577	1.4507	68.1828	34.9867	-180.2287	69.669	47.2988	-191.9615
1.776	68.5847	40.9779	-188.4165	0.642	1.3281	66.8768	34.0784	-183.1019	70.2926	47.8774	-193.7311
1.8	68.4541	41.6891	-189.5299	0.5747	1.4277	67.551	35.4238	-185.4305	69.3571	47.9544	-193.6293
1.824	66.194	42.7582	-190.846	0.4846	1.3512	64.7868	36.4527	-187.445	67.6012	49.0637	-194.247
1.848	68.0987	44.7907	-192.4288	0.4694	1.3982	67.0012	38.495	-189.1873	69.1962	51.0863	-195.6704
1.872	68.0598	47.4092	-194.7344	0.4465	1.5488	67.9328	41.6265	-191.9655	68.1868	53.1918	-197.5032
1.896	68.082	48.7938	-196.1128	0.4078	1.5066	67.7159	43.1001	-193.6477	68.4481	54.4875	-198.5779
1.92	67.4946	49.6311	-196.823	0.2975	1.5177	67.1941	43.9709	-195.0849	67.7952	55.2914	-198.5612
1.944	68.381	51.1274	-197.2808	0.067	1.2486	66.0973	44.2858	-196.7968	70.6647	57.9691	-197.7649
1.968	69.2682	52.5999	-198.1327	0.0534	1.1433	66.6523	46.8583	-197.7954	71.884	58.3416	-198.4699
1.992	69.2775	53.2779	-199.7918	0.013	1.1441	67.2291	48.7718	-199.7274	71.3258	57.7839	-199.8562
2.016	70.1363	54.4434	-200.7075	-0.1271	1.272	68.7042	49.7938	-201.3293	71.5683	59.0929	-200.0857
2.04	70.1092	57.1385	-200.4687	-0.4509	1.3884	69.1122	51.7343	-203.129	71.1061	62.5428	-200.8083
2.064	69.8785	58.5438	-200.7749	-0.4865	1.4597	69.337	53.688	-203.3591	70.42	63.3997	-198.1906
2.088	70.9353	58.9551	-201.6682	-0.4597	1.4496	70.2661	53.462	-204.4081	71.6045	64.4483	-198.9282
2.112	71.2023	59.5396	-201.9361	-0.4792	1.4204	70.2831	53.4721	-205.1245	72.1215	65.6072	-198.7477
2.136	72.0121	61.6691	-201.5439	-0.7375	1.3473	71.0184	57.2975	-205.6166	73.0057	66.0407	-197.4712
2.16	72.133	62.3419	-201.9473	-0.9609	1.5848	72.1787	59.0825	-206.6126	72.0872	65.6013	-197.282
2.184	72.3812	63.2575	-202.4148	-0.8864	1.5004	72.1298	59.6943	-206.7923	72.6326	66.8208	-198.0373
2.208	72.5001	63.613	-202.4295	-0.9148	1.7212	73.1122	59.5753	-207.7352	71.888	67.6508	-197.1237
2.232	73.1286	63.796	-202.622	-0.9915	1.7299	73.7182	60.1223	-208.31	72.539	67.4697	-196.9341
2.256	73.0335	65.1357	-203.2096	-1.081	1.8477	73.9193	62.0185	-209.2882	72.1477	68.2528	-197.1311
2.28	74.0421	66.1315	-203.4948	-1.0663	1.8808	75.0804	62.8901	-209.6586	73.0037	69.373	-197.3311
2.304	73.6033	65.9648	-203.8659	-1.0281	1.7371	74.1816	62.5207	-209.6561	73.0251	69.4088	-198.0758
2.328	74.3135	66.712	-203.9829	-1.0142	2.1717	76.2599	63.8723	-209.5161	72.3672	69.5517	-198.4497
2.352	74.5791	67.6708	-204.5811	-1.1379	2.161	76.2019	65.2482	-210.8911	72.9564	70.0934	-198.2712
2.376	75.082	67.8828	-206.5431	-1.1143	2.318	77.1568	65.643	-212.7607	73.0072	70.1227	-200.3256
2.4	74.5821	68.0189	-206.4549	-1.053	2.4012	77.1573	65.6655	-212.5793	72.0068	70.3724	-200.3304
2.424	75.5825	68.5129	-208.1854	-1.1343	2.7979	78.385	67.5099	-214.5668	72.7799	69.5158	-201.8039
2.448	75.8704	69.1137	-209.3281	-1.0835	2.8124	79.3517	67.9243	-216.2712	72.3891	70.3031	-202.3849
2.472	76.4497	69.955	-209.8337	-1.1773	2.6591	78.973	68.6334	-216.6943	73.9264	71.2766	-202.9732
2.496	75.5787	68.7047	-210.7532	-1.1554	2.7365	78.8244	67.3128	-218.7591	72.333	70.0966	-202.7472
2.52	76.5235	69.1085	-211.5259	-1.1574	2.8212	79.9053	67.9863	-219.6484	73.1417	70.2307	-203.4035
2.544	75.8515	68.7627	-212.7163	-1.228	2.6743	78.2575	67.5488	-220.2675	73.4456	69.9766	-205.165
2.568	75.6102	68.939	-213.9907	-1.3191	2.6511	77.4227	67.9712	-221.9821	73.7976	69.9069	-205.9994
2.592	75.6005	69.6971	-215.2057	-1.2509	2.6031	77.6474	68.4744	-222.4033	73.5535	70.9198	-208.0082
2.616	75.9586	69.1414	-217.1702	-1.2079	2.7157	78.5877	67.9486	-224.7747	73.3294	70.3343	-209.5658
2.64	75.7208	69.34	-218.9119	-1.1871	2.6494	78.2733	67.9715	-226.0858	73.1682	70.7086	-211.738
2.664	75.5481	69.7378	-220.6182	-1.1611	2.5299	78.2518	67.8413	-228.2236	72.8444	71.6343	-213.0128
2.688	76.4938	69.726	-222.0543	-1.1401	2.2624	78.6611	67.1084	-229.4498	74.3265	72.3436	-214.6588
2.712	75.5768	69.6791	-223.181	-1.1133	2.283	77.8924	66.9969	-230.3778	73.2611	72.3613	-215.9841
2.736	75.275	70.1813	-225.1587	-1.1033	2.0202	76.6165	67.3997	-231.2766	73.9336	72.9629	-219.0407
2.76	75.6835	70.1202	-226.3256	-0.9701	2.0051	77.1722	66.9106	-231.4891	74.1948	73.3298	-221.162
2.784	75.8145	69.8788	-227.6636	-0.8254	2.0082	77.3965	66.4962	-231.7091	74.2326	73.2614	-223.618
2.808	77.5643	68.7499	-229.4342	-0.5514	2.1605	79.7997	65.4091	-231.9067	75.3289	72.0907	-226.9618
2.832	79.3787	67.7802	-230.5839	-0.3384	2.0921	81.827	63.5175	-232.3137	76.9305	72.043	-228.8541
2.856	78.6361	67.9181	-231.9347	-0.3243	2.1416	81.6393	63.2409	-233.803	75.6329	72.5953	-230.0664
2.88	77.5843	66.8922	-234.6449	-0.2677	2.1083	80.0598	62.7386	-235.9713	75.1088	71.0458	-233.3185
2.904	78.8864	68.0817	-235.9438	-0.0258	2.4026	83.5045	63.8732	-236.105	74.2683	72.2901	-235.7826
2.928	75.1391	67.8862	-236.3216	0.0286	2.5153	80.6372	63.9088	-236.1278	69.641	71.8636	-236.5155
2.952	78.0218	67.5211	-238.3251	0.0487	2.656	85.0424	63.8158	-237.9381	71.0011	71.2265	-238.712
2.976	76.9761	66.7381	-239.6823	0.0994	2.5485	82.9822	62.6901	-238.9602	70.97	70.7861	-240.4043

Rock12

time	pos(x)	pos(y)	pos(z)	el	az	x1	y1	z1	x2	y2	z2
3	75.7241	67.7325	-241.6593	0.2188	2.5687	83.072	62.993	-239.7153	68.3762	72.4721	-243.6034
3.024	75.462	67.1419	-243.4249	0.1797	2.6494	83.1926	62.997	-241.8315	67.7314	71.2867	-245.0184
3.048	75.2708	67.5871	-245.0367	0.0719	2.6707	84.6593	62.8075	-244.2784	65.8824	72.3668	-245.7951
3.072	73.9744	67.5496	-246.1633	0.0605	2.6514	83.7745	62.32	-245.49	64.1742	72.7792	-246.8366
3.096	73.7789	66.7026	-247.0945	0.1112	2.6515	82.3225	62.1447	-246.0133	65.2354	71.2606	-248.1756
3.12	73.4734	66.4103	-248.2211	0.0913	2.7374	83.0828	62.2998	-247.2641	63.8639	70.5207	-249.1782
3.144	73.4351	67.6754	-249.3645	0.1166	2.6112	82.0866	62.6012	-248.1896	64.7836	72.7496	-250.5394
3.168	70.3377	66.9213	-251.1325	0.154	2.6373	79.1337	62.0666	-249.5732	61.5417	71.776	-252.6918
3.192	69.2803	65.6812	-252.9886	0.1868	2.6737	76.3248	62.1213	-251.497	62.2357	69.2411	-254.4802
3.216	70.3265	66.2477	-254.4229	0.2337	2.6031	76.5822	62.5107	-252.6881	64.0708	69.9846	-256.1578
3.24	72.7663	64.857	-255.9425	0.0484	2.6534	81.5116	60.2125	-255.4627	64.0209	69.5016	-256.4224
3.264	69.8682	66.4196	-257.055	0.0068	2.6553	78.2219	62.0038	-256.9906	61.5146	70.8355	-257.1194
3.288	69.9047	66.3783	-258.7519	-0.0961	2.6934	78.4805	62.2549	-259.6694	61.3289	70.5016	-257.8344
3.312	68.3723	65.9211	-259.9868	-0.235	2.6992	75.8404	62.3834	-261.9649	60.9041	69.4588	-258.0087
3.336	69.1966	66.1821	-260.4277	-0.2516	2.6388	75.8722	62.5112	-262.3857	62.5209	69.853	-258.4696
3.36	66.4409	64.428	-262.2873	-0.1797	2.6982	75.1519	60.2905	-264.0391	57.7298	68.5655	-260.5355
3.384	64.7135	65.254	-263.468	-0.3166	2.7304	71.6662	62.2225	-265.9526	57.7608	68.2855	-260.9833
3.408	67.0364	65.7294	-263.2719	-0.3742	2.8407	72.2588	64.1086	-265.4195	61.814	67.3501	-261.1243
3.432	67.4985	64.6237	-265.3871	-0.2962	2.8466	74.6821	62.4412	-267.678	60.3148	66.8063	-263.0963
3.456	68.1875	64.0003	-267.2245	-0.5825	2.759	73.4405	61.8862	-270.9542	62.9345	66.1144	-263.4947
3.48	68.3417	64.1544	-268.0545	-0.7122	3.0835	71.2308	63.9864	-270.5528	65.4526	64.3223	-265.5562
3.504	66.8064	63.5756	-269.4755	-0.7837	-2.5363	68.8675	65.0018	-271.9733	64.7453	62.1494	-266.9777
3.528	65.6952	64.6648	-270.0813	-0.696	-2.5327	67.6813	66.0496	-272.104	63.7091	63.28	-268.0586
3.552	64.8425	63.6496	-271.8633	-0.5601	-2.1593	66.4916	66.1208	-273.7264	63.1934	61.1785	-270.0003
3.576	64.1607	64.0408	-272.2983	-0.5848	-2.4107	66.4118	66.0591	-274.3002	61.9095	62.0224	-270.2965
3.6	63.576	64.4105	-273.5543	-0.434	-2.1168	65.5674	67.6875	-275.3316	61.5846	61.1335	-271.777
3.624	62.9468	64.3683	-274.5359	-0.3854	-2.3192	65.4142	67.0256	-276.007	60.4793	61.711	-273.0648
3.648	66.4402	63.704	-276.6729	-0.4641	-1.7986	67.3913	67.807	-278.7809	65.4891	59.601	-274.5648
3.672	63.9426	64.6847	-277.7801	-0.4509	-2.3492	67.802	68.5982	-280.441	60.0831	60.7712	-275.1191
3.696	64.7474	64.2317	-280.0267	-0.4603	-2.2594	67.6845	67.8007	-282.3185	61.8102	60.6626	-277.7349
3.72	65.5277	63.9205	-281.8254	-0.2281	-2.8527	73.1155	66.1758	-283.6627	57.94	61.6652	-279.988
3.744	64.7374	63.3506	-283.7502	-0.0221	-2.9912	78.5671	65.4464	-284.0597	50.9076	61.2549	-283.4408
3.768	68.0487	62.832	-284.1446	0.0082	-2.9906	81.1595	64.8264	-284.0353	54.9379	60.8376	-284.2539
3.792	66.8797	62.8079	-286.5338	0.0529	-3.0331	81.1737	64.3643	-285.7722	52.5856	61.2516	-287.2953
3.816	66.9062	62.9802	-287.1815	0.0488	-3.0207	81.3012	64.7285	-286.4727	52.5112	61.2319	-287.8902
3.84	65.6585	63.1285	-288.4617	0.0852	-2.9015	77.5102	66.0295	-287.4192	53.8069	60.2276	-289.5043
3.864	70.3171	63.5076	-289.7965	0.0594	-2.9015	83.8981	66.8327	-288.9647	56.7361	60.1824	-290.6283
3.888	69.0439	63.3482	-291.8269	0.1213	-2.8896	82.5236	66.8181	-290.1302	55.5642	59.8784	-293.5235
3.912	69.3056	63.813	-292.7487	0.0869	-2.8743	83.027	67.5699	-291.5095	55.5843	60.0561	-293.9879
3.936	69.6204	62.6525	-293.6766	0.1341	-2.8089	82.7942	67.2049	-291.7964	56.4467	58.1002	-295.5568
3.96	69.4996	62.5905	-294.9728	0.2052	-2.5728	78.6958	68.47	-292.7014	60.3034	56.7111	-297.2442
3.984	67.2178	61.9197	-297.2277	0.253	-2.5084	75.5134	68.0089	-294.567	58.9223	55.8305	-299.8884
4.008	67.5105	62.4526	-299.5637	0.1736	-2.4648	74.3115	67.9163	-298.034	60.7095	56.989	-301.0933
4.032	67.2047	61.6297	-300.4684	0.2373	-2.5985	73.4223	65.3833	-298.7114	60.987	57.8761	-302.2253
4.056	67.9364	61.2202	-302.7753	0.1867	-2.5029	73.6383	65.4537	-301.4342	62.2346	56.9868	-304.1165
4.08	68.7434	61.141	-303.2674	0.2424	-2.6192	76.4248	65.5636	-301.076	61.062	56.7185	-305.4588
4.104	68.304	61.0728	-305.6745	0.1122	-2.42	74.1386	66.2063	-304.7992	62.4695	55.9392	-306.5498

Rockan

time	pos(x)	pos(y)	pos(z)	el	az	x1	y1	z1	x2	y2	z2
0	0	0	0	1.2093	0.1689	-2.8294	-0.4826	7.5916	2.8294	0.4826	-7.5916
0.024	2.7145	1.2329	-4.5142	1.0464	0.2445	-1.0641	0.29	2.2184	6.4932	2.1758	-11.2467
0.048	4.2548	2.489	-8.9858	0.7687	0.414	-0.5619	0.3725	-3.8973	9.0716	4.6055	-14.0743
0.072	6.4871	4.267	-13.2782	0.33	0.4991	-0.1904	0.6271	-10.6734	13.1646	7.9068	-15.883
0.096	8.7138	4.4108	-16.5365	-0.0094	0.6548	2.1463	-0.6322	-16.6144	15.2814	9.4538	-16.4586
0.12	11.1467	5.1979	-17.9123	-0.3752	0.6755	6.8307	1.7396	-20.0906	15.4627	8.6561	-15.7341
0.144	15.3338	6.1831	-19.6121	-0.4513	0.7717	10.931	1.8993	-22.5896	19.7367	10.4669	-16.6346
0.168	18.5971	7.608	-21.0117	-0.794	1.2645	17.3485	3.6601	-25.224	19.8458	11.5559	-16.7994
0.192	20.7537	8.5472	-21.5907	-0.9401	1.7591	21.4014	5.1485	-26.329	20.1061	11.946	-16.8523
0.216	23.7928	9.2703	-22.975	-0.7357	2.1761	26.2602	5.7049	-26.8999	21.3255	12.8358	-19.0502
0.24	27.0663	9.6427	-23.5529	-0.5124	2.7002	32.517	7.067	-26.9437	21.6156	12.2183	-20.162
0.264	26.2902	11.9942	-24.414	-0.3367	2.7403	34.2773	8.6052	-27.4514	18.303	15.3832	-21.3766
0.288	28.6685	11.3722	-25.3172	-0.1687	2.9253	35.923	9.7779	-26.5825	21.4139	12.9664	-24.052
0.312	30.5129	11.1895	-26.1474	-0.1677	2.9389	38.4286	9.5629	-27.5155	22.5972	12.816	-24.7793
0.336	33.0363	10.8468	-27.7054	0.1141	2.989	40.3466	9.7227	-26.8577	25.7259	11.971	-28.5531

Rock13

time	pos(x)	pos(y)	pos(z)	el	az	x1	y1	z1	x2	y2	z2
0.36	34.0214	11.2363	-27.3436	0.1615	2.9136	41.8203	9.427	-26.0394	26.2224	13.0455	-28.6478
0.384	34.9862	11.8499	-28.1334	0.3132	2.9128	41.6283	10.3031	-25.9247	28.344	13.3967	-30.3421
0.408	37.3839	12.0964	-28.0273	0.5004	2.9623	43.5209	10.984	-24.6164	31.2468	13.2089	-31.4382
0.432	38.1496	12.5761	-27.8196	0.4567	2.9482	45.044	11.2262	-24.3678	31.2551	13.926	-31.2715
0.456	39.4668	13.0791	-28.6399	0.5055	2.9398	46.07	11.7285	-24.9098	32.8636	14.4296	-32.3701
0.48	40.8612	13.6526	-28.3722	0.5648	2.9804	47.4418	12.5828	-24.1479	34.2806	14.7224	-32.5966
0.504	41.9692	14.0011	-29.2073	0.6029	3.0365	48.556	13.3062	-24.6481	35.3824	14.696	-33.7665
0.528	43.1067	14.7773	-28.9289	0.6761	2.9816	48.6637	13.8805	-24.4129	37.5497	15.6741	-33.445
0.552	43.9396	14.6756	-29.3261	0.6098	2.9335	50.0383	13.3881	-24.9717	37.8409	15.9631	-33.6805
0.576	45.5082	15.0721	-30.4584	0.6391	2.9384	51.4668	13.8443	-25.9373	39.5497	16.3	-34.9795
0.6	46.2233	15.1235	-30.6494	0.8326	2.7888	50.6678	13.487	-25.4436	41.7789	16.76	-35.8552
0.624	46.0803	16.4329	-31.2484	0.5388	2.8831	53.0739	14.5839	-26.9245	39.0867	18.2818	-35.5723
0.648	47.2524	16.8193	-32.2752	0.5167	2.9483	54.2611	15.4477	-28.217	40.2437	18.1908	-36.3333
0.672	46.2707	17.0822	-33.3735	0.4609	2.9726	54.2217	15.7259	-29.3681	38.3197	18.4385	-37.379
0.696	45.4842	17.1865	-33.3526	0.6052	2.9264	51.5149	15.8681	-29.0816	39.4535	18.5049	-37.6235
0.72	44.3029	17.5929	-34.1092	0.525	2.8664	50.9225	15.7238	-30.1246	37.6832	19.462	-38.0938
0.744	44.0754	17.3843	-35.9166	0.5497	2.9441	50.8766	16.0232	-31.6668	37.2741	18.7455	-40.1664
0.768	43.6481	17.8684	-36.8459	0.4225	2.9596	51.217	16.4758	-33.3859	36.0791	19.261	-40.3059
0.792	43.6704	17.8053	-37.7299	0.3657	2.9129	50.5807	16.1966	-35.0128	36.7601	19.4139	-40.447
0.816	44.175	18.0379	-38.0646	0.3331	2.9362	50.6011	16.6989	-35.7938	37.749	19.377	-40.3354
0.84	44.2692	18.0287	-40.2608	0.2355	2.8724	50.4874	16.3129	-38.7126	38.0511	19.7445	-41.809
0.864	43.0117	17.6698	-41.5109	0.25	2.9247	50.4805	16.0241	-39.558	35.543	19.3156	-43.4638
0.888	41.9405	18.1772	-42.5283	0.0185	2.8388	51.9779	15.041	-42.3341	31.9031	21.3134	-42.7225
0.912	40.7259	18.3197	-43.4621	-0.095	2.8458	50.0609	15.4754	-44.3916	31.3908	21.1641	-42.5325
0.936	40.0314	18.221	-44.2409	-0.1655	2.8688	49.9556	15.4446	-45.962	30.1072	20.9973	-42.5199
0.96	39.82	19.2489	-44.084	-0.2045	2.8695	49.1219	16.6534	-46.0873	30.5181	21.8444	-42.0807
0.984	38.7076	19.5622	-44.6399	-0.268	2.9303	46.912	17.8024	-46.9441	30.5031	21.3219	-42.3357
1.008	38.4081	18.5391	-45.4109	-0.3509	2.957	46.3194	17.0616	-48.3567	30.4967	20.0167	-42.4651
1.032	37.0541	19.0597	-46.0844	-0.494	2.8742	43.442	17.3098	-49.6515	30.6661	20.8097	-42.5173
1.056	39.1041	19.2898	-46.6971	-0.6024	2.7398	45.2047	16.6977	-51.2552	33.0034	21.8819	-42.1389
1.08	37.5344	19.1042	-47.0876	-0.6195	2.7886	44.1078	16.6822	-52.0838	30.961	21.5262	-42.0915
1.104	38.0855	19.3842	-48.2352	-0.7323	2.6063	42.9904	16.4757	-53.3615	33.1807	22.2928	-43.1088
1.128	36.5957	20.1637	-48.9587	-0.7031	2.6553	42.1405	17.2324	-54.2748	31.0508	23.0949	-43.6426
1.152	35.6927	19.9609	-49.2857	-0.8585	2.6519	40.2312	17.5419	-55.2414	31.1541	22.3798	-43.33
1.176	37.5828	19.843	-51.2931	-0.8302	2.5206	42.6473	16.2198	-58.1042	32.5184	23.4663	-44.482
1.2	36.3735	19.8483	-51.8201	-0.8334	2.5516	40.7422	16.9232	-57.6085	32.0047	22.7734	-46.0317
1.224	35.6036	19.6126	-53.4342	-0.8086	2.5455	40.3297	16.406	-59.4165	30.8774	22.8192	-47.4519
1.248	36.2288	20.5871	-54.8175	-0.835	2.5886	41.0206	17.6298	-61.0366	31.4371	23.5445	-48.5985
1.272	36.4777	21.1024	-55.8345	-0.7197	2.3756	41.1311	16.6264	-61.494	31.8244	25.5783	-50.175
1.296	36.3827	20.7191	-57.4979	-0.6408	2.5296	41.3589	17.2264	-62.0318	31.4066	24.2117	-52.9639
1.32	37.5411	20.2054	-58.742	-0.5789	2.7195	43.8579	17.3689	-63.268	31.2243	23.0419	-54.216
1.344	37.5155	20.3464	-60.3384	-0.5196	2.8089	45.1768	17.6993	-64.9751	29.8542	22.9936	-55.7018
1.368	37.9057	20.5721	-61.9842	-0.4238	2.8489	45.4234	18.3068	-65.5266	30.3881	22.8373	-58.4418
1.392	38.8203	20.3626	-62.8638	-0.3771	2.8396	46.6047	17.9373	-66.0926	31.0359	22.7879	-59.6349
1.416	38.1517	20.4381	-64.4727	-0.1963	2.8716	46.7612	18.0558	-66.2491	29.5422	22.8204	-62.6963
1.44	38.4479	20.2212	-65.7791	-0.2031	2.7711	47.0492	16.8803	-67.6791	29.8465	23.5621	-63.879
1.464	39.3215	19.5025	-67.4058	-0.094	2.9026	48.6028	17.2412	-68.3067	30.0401	21.7637	-66.5048
1.488	40.3905	20.3523	-68.6227	-0.0292	2.8581	49.1071	17.8132	-68.8879	31.6739	22.8913	-68.3575
1.512	41.4792	20.8056	-69.8544	0.2133	3.0576	51.3078	19.9779	-67.7179	31.6505	21.6334	-71.9909
1.536	42.8017	20.782	-70.4124	0.1827	2.9362	51.9481	18.8762	-68.686	33.6553	22.6877	-72.1389
1.56	43.0296	21.1738	-71.0631	0.2872	2.9886	52.2603	19.7504	-68.3045	33.7988	22.5973	-73.8217
1.584	43.3081	21.2938	-72.2494	0.2403	2.9374	52.9449	19.2986	-69.8384	33.6713	23.2889	-74.6603
1.608	44.7302	22.1513	-72.6627	0.3691	2.9439	52.5432	20.586	-69.5803	36.9171	23.7167	-75.7451
1.632	44.0026	22.3447	-73.6466	0.462	2.9438	51.5267	20.8366	-69.8255	36.4785	23.8528	-77.4676
1.656	44.3979	22.4203	-73.9395	0.5106	2.9147	51.1638	20.8582	-70.0501	37.6319	23.9823	-77.829
1.68	45.552	23.1582	-74.2939	0.5007	2.9206	53.4569	21.3826	-69.8609	37.6471	24.9338	-78.7269
1.704	45.5279	23.5034	-76.4247	0.4974	2.9806	52.9758	22.2936	-72.3281	38.0799	24.7132	-80.5213
1.728	46.9942	24.1513	-77.0102	0.5047	2.9028	54.5526	22.3116	-72.7132	39.4358	25.991	-81.3073
1.752	46.569	24.0566	-77.5626	0.5539	2.9667	53.9527	22.7519	-72.9247	39.1853	25.3614	-82.2005
1.776	46.338	24.1086	-78.7742	0.4706	3.0568	54.7405	23.3945	-74.4845	37.9355	24.8228	-83.064
1.8	46.6794	24.8245	-80.6898	0.5616	-3.0694	55.8478	25.4878	-74.9062	37.511	24.1613	-86.4735
1.824	47.5178	25.6548	-80.9546	0.5467	3.0712	56.035	25.0544	-75.7586	39.0006	26.2552	-86.1506
1.848	47.2704	25.9939	-81.7924	0.4413	3.0963	56.4509	25.5777	-77.4518	38.0899	26.4102	-86.133
1.872	47.1116	26.267	-82.8066	0.4814	-3.1212	56.9227	26.4671	-77.6797	37.3004	26.0668	-87.9335
1.896	46.4368	26.5196	-84.1062	0.4529	-3.1408	56.1798	26.5274	-79.3647	36.6937	26.5117	-88.8478
1.92	46.1861	26.648	-86.1261	0.4322	-3.1153	55.5232	26.8933	-81.8174	36.849	26.4026	-90.4348

Rock13

time	pos(x)	pos(y)	pos(z)	el	az	x1	y1	z1	x2	y2	z2
1.944	45.3286	26.5829	-87.7008	0.3682	3.1388	55.3625	26.5553	-83.8299	35.2948	26.6105	-91.5716
1.968	45.5886	27.0583	-88.1272	0.3795	-3.0693	55.3669	27.7661	-84.2171	35.8103	26.3505	-92.0373
1.992	44.5147	27.3943	-89.6458	0.2733	-3.1155	55.5336	27.6822	-86.556	33.4957	27.1065	-92.7356
2.016	44.3475	27.6617	-90.4793	0.2285	3.1393	54.6263	27.6377	-88.0885	34.0686	27.6857	-92.87
2.04	43.5188	27.9104	-91.5889	0.2154	3.1076	53.1806	27.5823	-89.474	33.857	28.2385	-93.7038
2.064	42.3933	27.5295	-92.8028	0.0254	2.9683	52.3567	25.7856	-92.546	32.4299	29.2734	-93.0596
2.088	41.3263	28.2451	-93.1598	-0.0572	2.9194	50.9859	26.0623	-93.7267	31.6668	30.4278	-92.5928
2.112	40.3081	26.5329	-95.4485	-0.0539	3.0274	50.117	25.4074	-95.981	30.4991	27.6583	-94.916
2.136	39.7656	27.5402	-95.6062	-0.1249	3.0374	49.9385	26.4766	-96.8907	29.5926	28.6037	-94.3217
2.16	38.4967	27.337	-96.5704	-0.1423	3.0223	47.928	26.2061	-97.9312	29.0654	28.4678	-95.2097
2.184	37.4104	27.6673	-96.984	-0.1312	3.0324	46.8139	26.636	-98.2326	28.0069	28.6986	-95.7355
2.208	36.9907	27.6738	-97.9113	-0.2491	2.9946	47.0491	26.185	-100.4976	26.9324	29.1625	-95.3251
2.232	35.5992	27.3742	-99.0155	-0.3691	2.9432	43.4524	25.7954	-102.1142	27.746	28.9531	-95.9168
2.256	35.3828	27.1107	-99.3509	-0.4357	2.9307	43.0275	25.4745	-102.9902	27.7381	28.7469	-95.7115
2.28	35.3828	27.65	-100.6994	-0.5071	2.9474	43.549	26.0442	-105.3235	27.2166	29.2559	-96.0753
2.304	34.4813	27.9999	-101.7113	-0.5835	2.9146	42.4076	26.169	-107.0823	26.555	29.8308	-96.3402
2.328	35.8563	28.176	-102.7909	-0.6495	3.0443	43.1391	27.4653	-108.3481	28.5735	28.8867	-97.2337
2.352	35.3556	28.569	-103.6302	-0.7353	3.0088	42.3904	27.6291	-110.0491	28.3208	29.5089	-97.2112
2.376	35.0723	29.1055	-104.9245	-0.7	2.9856	42.1862	27.9869	-110.9901	27.9585	30.2241	-98.8588
2.4	36.195	28.8848	-106.532	-0.8558	-3.0667	41.9073	29.3135	-113.1292	30.4828	28.456	-99.9349
2.424	35.808	30.285	-107.4354	-0.7964	-3.0814	42.2908	30.6753	-114.0746	29.3253	29.8946	-100.7962
2.448	34.4115	29.2807	-109.4716	-0.7965	-3.1005	41.2543	29.5622	-116.4747	27.5687	28.9993	-102.4686
2.472	35.2162	30.3041	-110.6014	-0.8408	-3.0952	41.6013	30.6005	-117.7441	28.8312	30.0077	-103.4588
2.496	35.5891	30.6658	-112.9528	-0.8079	-3.1131	42.5695	30.865	-120.2579	28.6087	30.4666	-105.6477
2.52	36.1577	31.2345	-113.5889	-0.8508	-3.1045	42.6934	31.4769	-121.0464	29.622	30.9921	-106.1313
2.544	36.6756	31.625	-115.6166	-0.8352	-3.0924	43.4113	31.9564	-123.0679	29.94	31.2935	-108.1652
2.568	37.4234	31.2987	-118.6517	-0.7642	-2.9459	44.5581	32.7129	-125.623	30.2887	29.8846	-111.6804
2.592	37.7613	32.2691	-119.9565	-0.7161	-2.9126	44.9719	33.9496	-126.3994	30.5506	30.5887	-113.5135
2.616	39.2248	32.9621	-121.4055	-0.5976	-2.9542	47.5534	34.5414	-127.175	30.8963	31.3827	-115.6361
2.64	39.5934	33.605	-123.3656	-0.4988	-2.8812	48.6334	36.0138	-128.4617	30.5534	31.1962	-118.2694
2.664	40.4233	34.8041	-125.2322	-0.4335	-2.8163	49.2937	37.7957	-129.5647	31.5529	31.8125	-120.8997
2.688	40.5113	34.824	-126.4843	-0.3387	-2.6579	48.1326	38.8279	-129.5167	32.8901	30.8202	-123.4519
2.712	41.7441	36.673	-128.4418	-0.1845	-2.5643	49.826	41.9374	-130.2415	33.6621	31.4087	-126.642
2.736	41.0199	37.2348	-129.3433	-0.0269	-2.4631	48.4851	43.2528	-129.6016	33.5547	31.2168	-129.085
2.76	45.0522	37.5439	-131.5106	0.2131	-2.5762	52.1321	42.0356	-129.6961	37.9723	33.0523	-133.3252
2.784	45.8493	38.1373	-132.538	0.2468	-2.5227	52.4049	42.8061	-130.5099	39.2937	33.4684	-134.566
2.808	45.4514	39.0694	-133.3589	0.3225	-2.5414	52.4236	43.8411	-130.5352	38.4793	34.2976	-136.1826
2.832	45.7175	39.1867	-135.1088	0.3524	-2.4646	52.2454	44.4337	-132.0287	39.1897	33.9398	-138.1888
2.856	46.3443	40.0756	-136.5746	0.4882	-2.4386	52.6732	45.4393	-132.1691	40.0154	34.7119	-140.9801
2.88	47.4825	40.4473	-137.9778	0.5193	-2.396	53.0253	45.5657	-133.6654	41.9396	35.329	-142.2901
2.904	47.5918	41.298	-138.927	0.5921	-2.4051	52.9585	46.1643	-134.0539	42.2251	36.4317	-143.8
2.928	49.7777	41.0403	-140.0534	0.6158	-2.3004	54.6893	46.5334	-134.8391	44.8661	35.5472	-145.2678
2.952	50.1068	41.1589	-141.5514	0.675	-2.414	54.8724	45.4029	-136.4432	45.3411	36.9149	-146.6595
2.976	51.4436	42.2058	-142.4448	0.6796	-2.3417	56.1799	47.0811	-136.9522	46.7073	37.3306	-147.9373
3	51.259	42.2022	-144.2294	0.7096	-2.0255	54.0469	47.9045	-138.7783	48.4711	36.4999	-149.6805
3.024	51.6675	41.4854	-146.2905	0.6351	-2.1212	54.8788	46.7182	-141.766	48.4561	36.2525	-150.8151
3.048	52.2663	43.0378	-146.791	0.5703	-2.4054	58.0139	48.2457	-141.816	46.5186	37.8299	-151.766
3.072	51.6372	42.9495	-148.3831	0.3662	-2.4518	57.9329	48.1438	-145.2535	45.3415	37.7551	-151.5127
3.096	52.7175	42.7039	-149.7458	0.4461	-2.3551	57.7494	47.7471	-146.3383	47.6855	37.6607	-153.1533
3.12	51.6181	43.1161	-150.6661	0.3714	-2.2959	57.0677	49.2664	-147.4657	46.1685	36.9658	-153.8665
3.144	52.3135	43.3837	-152.1848	0.3883	-2.2127	57.3119	50.0703	-148.7694	47.3152	36.697	-155.6001
3.168	54.5565	42.6469	-153.1109	0.271	-2.073	58.7914	50.3582	-150.6662	50.3216	34.9355	-155.5556
3.192	52.028	42.5825	-155.1592	0.2994	-2.2126	57.1001	49.3687	-152.5435	46.9558	35.7963	-157.7748
3.216	51.6411	43.0157	-156.4758	0.1884	-2.485	59.6018	49.1504	-154.56	43.6804	36.8811	-158.3916
3.24	50.7977	44.3111	-158.8873	0.1193	-2.4751	58.7779	50.5879	-157.6699	42.8176	38.0344	-160.1047
3.264	50.3725	43.0412	-159.0706	0.0824	-2.3416	57.3271	50.2022	-158.2464	43.4178	35.8802	-159.8948
3.288	50.7887	42.5762	-160.8343	0.0597	-2.4317	58.1574	48.9085	-160.2534	43.42	36.244	-161.4153
3.312	50.6949	42.2724	-161.8139	0.0824	-2.4299	58.0928	48.6534	-161.0073	43.2969	35.8913	-162.6206
3.336	49.8106	41.6136	-162.7186	0.0388	-2.374	56.5838	48.1495	-162.3527	43.0373	35.0778	-163.0844
3.36	47.2427	42.4764	-163.4541	0.0031	-2.4692	55.2504	48.8511	-163.422	39.235	36.1016	-163.4862
3.384	49.1218	41.2865	-164.9331	-0.0077	-2.5048	57.6849	47.6201	-165.015	40.5587	34.9529	-164.8511
3.408	46.8858	41.987	-165.6864	-0.0766	-2.4084	54.6005	48.9359	-166.4828	39.171	35.0382	-164.89
3.432	45.922	41.9262	-166.866	-0.1515	-2.3899	53.2313	48.759	-168.3939	38.6126	35.0934	-165.3381
3.456	46.9225	40.5018	-168.0581	-0.279	-2.5662	54.1281	45.1758	-170.5183	39.717	35.8278	-165.5978
3.48	45.01	41.3482	-168.8141	-0.3454	-2.4983	51.2278	46.0097	-171.6101	38.7921	36.6868	-166.018
3.504	45.4432	42.0245	-170.0555	-0.3163	-2.3696	52.1766	48.5805	-173.131	38.7097	35.4686	-166.98

Rock13

time	pos(x)	pos(y)	pos(z)	el	az	x1	y1	z1	x2	y2	z2
3.528	45.6316	43.4108	-171.23	-0.3442	-2.364	52.9096	50.5761	-174.8914	38.3537	36.2455	-167.5686
3.552	45.9354	42.1338	-172.8661	-0.4534	-2.3884	52.3642	48.1618	-177.16	39.5065	36.1058	-168.5722
3.576	44.6375	42.1914	-173.8529	-0.6137	-2.3787	49.6538	46.9871	-178.7418	39.6212	37.3956	-168.964
3.6	45.2292	41.5653	-175.4381	-0.5844	-2.3284	50.8214	47.4769	-180.8208	39.637	35.6537	-170.0555
3.624	45.0484	42.9474	-176.2695	-0.6322	-2.3642	49.941	47.762	-181.297	40.1559	38.1328	-171.2419
3.648	45.2885	41.8023	-177.5737	-0.7062	-2.3542	50.2614	46.795	-183.5837	40.3156	36.8096	-171.5638
3.672	45.546	42.1083	-179.8771	-0.6894	-2.2662	50.3078	47.8152	-186.0043	40.7842	36.4013	-173.75
3.696	45.1528	42.8374	-181.3201	-0.7684	-2.2018	49.2515	48.4468	-188.0349	41.0542	37.2279	-174.6053
3.72	45.3319	43.3244	-183.2351	-0.7725	-2.3437	50.2047	48.3203	-190.0358	40.4591	38.3286	-176.4343
3.744	46.5782	43.7094	-185.3154	-0.738	-2.2859	51.0686	48.8802	-191.544	42.0878	38.5385	-179.0868
3.768	47.0213	44.5362	-187.0002	-0.7806	-2.2899	51.2744	49.3943	-193.3958	42.7682	39.678	-180.6046
3.792	46.1871	43.9565	-188.9179	-0.7998	-2.221	50.3071	49.3742	-195.9227	42.067	38.5388	-181.9131
3.816	47.3031	44.6564	-191.4348	-0.7482	-2.3997	52.7627	49.6606	-198.3087	41.8435	39.6522	-184.5608
3.84	47.849	46.186	-193.5286	-0.6944	-2.4761	53.9183	50.9496	-199.9533	41.7798	41.4224	-187.104
3.864	46.2052	46.1168	-194.9298	-0.6508	-2.3503	51.4203	51.3935	-200.5787	40.9901	40.8402	-189.2808
3.888	47.9341	47.116	-197.5083	-0.4905	-2.5131	55.1533	52.3633	-202.2741	40.7148	41.8687	-192.7425
3.912	48.2275	47.0449	-199.0673	-0.4674	-2.5056	55.0618	52.0909	-203.3552	41.3933	41.9989	-194.7795
3.936	48.3732	47.3912	-200.3633	-0.364	-2.4752	55.3609	52.8858	-203.7498	41.3855	41.8966	-196.9769
3.96	47.7722	47.5858	-202.1821	-0.2506	-2.4566	53.9075	52.5978	-204.2102	41.6369	42.5738	-200.154
3.984	47.4853	48.6012	-204.241	-0.1688	-2.4197	53.3382	53.7545	-205.5699	41.6325	43.448	-202.9121
4.008	47.9911	48.0502	-205.8724	-0.1337	-2.4604	54.1219	53.0204	-206.9337	41.8603	43.0801	-204.8111
4.032	47.307	47.8747	-207.8511	-0.0111	-2.4101	53.1555	53.1242	-207.938	41.4585	42.6252	-207.7643
4.056	47.6105	48.2304	-209.6544	0.0495	-2.4126	52.7485	52.8195	-209.3131	42.4725	43.6413	-209.9956
4.08	47.777	49.0836	-211.6981	0.228	-2.3089	52.6863	54.4803	-210.005	42.8677	43.687	-213.3911
4.104	49.3848	48.73	-212.634	0.2736	-2.2973	53.6952	53.5808	-210.8127	45.0744	43.8792	-214.4553
4.128	50.7377	50.6201	-214.7917	0.281	-1.9868	53.8476	57.6602	-212.5704	47.6279	43.58	-217.0129
4.152	51.4993	50.6866	-216.2227	0.3288	-2.0985	54.9099	56.5386	-213.9121	48.0888	44.8347	-218.5333
4.176	52.4425	51.4452	-216.8188	0.2691	-2.0021	55.5888	58.2818	-214.7436	49.2961	44.6085	-218.894
4.2	51.9823	51.8633	-218.8267	0.2918	-2.0843	55.6238	58.3195	-216.6006	48.3408	45.407	-221.0529
4.224	52.1005	52.0669	-220.4199	0.4368	-2.0953	55.4221	57.8081	-217.3231	48.779	46.3257	-223.5166
4.248	50.7574	51.866	-222.3219	0.504	-2.0603	54.3544	58.6175	-218.1027	47.1604	45.1146	-226.541
4.272	54.261	52.0107	-222.8971	0.5168	-2.3549	59.4894	57.253	-218.6889	49.0325	46.7684	-227.1052
4.296	53.6761	51.9955	-224.5077	0.4606	-2.5745	60.5562	56.377	-220.4602	46.796	47.6139	-228.5552
4.32	53.7316	52.1433	-226.0409	0.3351	-2.5521	60.8314	56.8914	-223.0661	46.6317	47.3952	-229.0156
4.344	55.0081	51.491	-228.0827	0.2139	-2.7332	64.6206	55.6506	-225.8074	45.3956	47.3314	-230.3581
4.368	53.7013	51.4379	-229.54	0.1912	-2.7763	64.642	55.622	-227.2724	42.7606	47.2537	-231.8075
4.392	54.9365	51.2233	-230.6222	0.265	-2.8202	65.6541	54.7921	-227.5568	44.2189	47.6544	-233.6877
4.416	53.3228	52.1804	-232.7334	0.2503	-2.7717	63.4615	56.1121	-229.9528	43.184	48.2487	-235.5139
4.44	53.9537	50.1196	-234.4357	0.1789	-2.9078	64.9145	52.7299	-232.3985	42.9929	47.5092	-236.4729
4.464	53.3791	50.445	-235.5587	0.2232	-3.0297	64.4342	51.6873	-233.034	42.3241	49.2028	-238.0834
4.488	54.2435	51.0772	-236.5359	0.0992	3.1054	65.4164	50.6725	-235.4226	43.0705	51.482	-237.6491
4.512	53.0372	51.6582	-238.1048	0.1388	3.0028	65.1485	49.9663	-236.396	40.9259	53.3501	-239.8137
4.536	53.8937	51.8716	-240.283	0.0895	2.9903	65.3787	50.1203	-239.2406	42.4087	53.6229	-241.3254
4.56	52.8482	50.9563	-240.7324	0.1721	2.9238	62.164	48.8951	-239.0741	43.5324	53.0175	-242.3906
4.584	52.0743	50.8316	-241.9423	0.1241	2.8053	62.8148	47.0772	-240.5225	41.3338	54.586	-243.362
4.608	52.0849	50.2723	-242.9971	-0.0197	2.8124	61.7449	46.9727	-243.198	42.4249	53.5719	-242.7962
4.632	51.2515	49.757	-244.3913	0.0362	2.9034	62.993	46.9067	-243.9539	39.51	52.6074	-244.8287
4.656	50.6127	50.0421	-245.7415	-0.0214	2.8697	62.9707	46.5966	-246.0158	38.2548	53.4875	-245.4671
4.68	48.8923	50.5604	-246.2108	-0.059	2.8983	60.6836	47.6337	-246.9283	37.101	53.4871	-245.4933
4.704	47.9449	49.6028	-247.559	-0.1234	2.8781	59.5976	46.4596	-249.0557	36.2922	52.7459	-246.0622
4.728	47.2922	51.0436	-249.2065	-0.1299	2.8748	58.9097	47.8681	-250.78	35.6746	54.219	-247.633
4.752	47.5063	50.4253	-250.701	-0.14	2.9071	59.8126	47.4857	-252.4846	35.2	53.3649	-248.9173
4.776	49.5265	49.186	-253.1678	-0.2645	2.8349	60.9514	45.5678	-256.4137	38.1017	52.8042	-249.9218
4.8	47.7348	49.3228	-254.4202	-0.2538	2.8627	60.0829	45.7868	-257.7521	35.3866	52.8587	-251.0883
4.824	47.969	49.004	-255.3311	-0.3299	2.8844	58.3241	46.2802	-258.9976	37.6139	51.7278	-251.6645
4.848	48.6651	49.0569	-256.2286	-0.2945	2.8907	60.0173	46.1472	-259.7832	37.3128	51.9666	-252.674
4.872	48.336	48.1371	-258.4474	-0.4116	2.8636	57.9339	45.3985	-262.8041	38.7382	50.8758	-254.0907
4.896	49.7358	49.1303	-260.6007	-0.4681	2.9182	59.9039	46.8201	-265.8727	39.5677	51.4404	-255.3287
4.92	50.38	46.9212	-261.4969	-0.5878	2.9406	59.0476	45.1551	-267.3915	41.7124	48.6872	-255.6023
4.944	49.733	46.3899	-262.9578	-0.6002	2.9823	59.3911	44.8378	-269.6526	40.0748	47.942	-256.263
4.968	51.6004	46.0136	-265.1288	-0.5341	2.9823	61.8117	44.373	-271.2455	41.389	47.6542	-259.0121
4.992	52.3639	46.0155	-266.6021	-0.5001	3.078	62.2317	45.3868	-272.0047	42.496	46.6442	-261.1996
5.016	53.3805	46.5734	-268.0161	-0.5052	-3.0836	64.4166	47.214	-274.1297	42.3444	45.9327	-261.9025
5.04	53.7793	45.8053	-269.8492	-0.4836	-3.1086	63.97	46.1416	-275.2041	43.5886	45.4691	-264.4943
5.064	54.1267	44.6446	-270.9937	-0.4861	-3.066	65.1573	45.4806	-276.8391	43.0961	43.8087	-265.1483
5.088	55.8515	43.6988	-272.4107	-0.4285	-2.9572	66.5299	45.6902	-277.3723	45.1731	41.7073	-267.4492

Rock13

time	pos(x)	pos(y)	pos(z)	el	az	x1	y1	z1	x2	y2	z2
5.112	53.8378	45.1513	-273.7739	-0.536	-2.7183	61.1379	48.4405	-278.5305	46.5376	41.862	-269.0173
5.136	53.7493	44.4366	-275.5463	-0.4323	-2.6181	61.4128	48.8596	-279.6286	46.0858	40.0135	-271.4641
5.16	55.4496	45.5402	-277.2543	-0.4323	-2.49	62.1013	50.6139	-281.1148	48.7978	40.4664	-273.3938
5.184	54.1376	45.3296	-279.0008	-0.3644	-2.4973	60.6576	50.2276	-282.1112	47.6175	40.4315	-275.8904
5.208	54.2865	45.2352	-281.4331	-0.3031	-2.3463	59.8001	50.8594	-283.8961	48.7729	39.6109	-278.9701
5.232	55.9738	45.8158	-283.2269	-0.231	-2.3141	61.8521	52.2106	-285.2701	50.0955	39.421	-281.1838
5.256	55.1742	45.5901	-283.2452	-0.1503	-2.2542	60.1165	51.6597	-284.4307	50.232	39.5206	-282.0598
5.28	55.12	45.0842	-285.7791	-0.0221	-2.0993	59.1228	51.9385	-285.9549	51.1173	38.2298	-285.6034
5.304	56.6837	45.3499	-287.6768	0.0085	-2.3193	61.3426	50.3657	-287.6187	52.0248	40.3342	-287.7349
5.328	56.1094	45.3868	-289.2981	0.0795	-2.0506	58.8264	50.6082	-288.8292	53.3923	40.1655	-289.7671
5.352	57.8988	44.4033	-291.5966	0.0556	-2.1137	61.9862	51.1777	-291.156	53.8114	37.6289	-292.0371
5.376	58.6324	46.1706	-292.5976	0.1517	-2.1338	62.4654	52.2442	-291.4998	54.7994	40.097	-293.6953
5.4	57.7509	45.2426	-293.8553	0.2633	-1.8209	58.938	49.8895	-292.5624	56.5637	40.5957	-295.1481
5.424	58.4964	45.5186	-295.0952	0.2446	-1.6754	58.9444	49.7871	-294.024	58.0484	41.2502	-296.1665
5.448	58.451	44.9777	-297.0644	0.272	-1.5748	58.4646	48.3554	-296.1223	58.4373	41.5999	-298.0066
5.472	59.9818	43.587	-298.0316	0.4273	-1.1799	58.2334	47.8292	-295.9421	61.7302	39.3448	-300.1211
5.496	60.3374	43.5049	-298.1219	0.5628	-1.06	57.91	47.8365	-294.9894	62.7648	39.1733	-301.2543
5.52	59.9496	43.4692	-300.2174	0.3711	-0.7015	55.4978	47.2304	-297.9496	64.4015	39.708	-302.4853
5.544	61.207	43.2401	-301.7941	0.5042	-0.812	57.9617	46.6625	-299.1919	64.4523	39.8177	-304.3964
5.568	61.7329	42.8317	-302.8015	0.2866	-0.6462	55.7074	47.376	-300.5774	67.7583	38.2875	-305.0257
5.592	63.3988	41.7674	-304.7291	0.1962	-0.5425	57.6648	45.2242	-303.3981	69.1328	38.3106	-306.0601
5.616	63.8812	42.7441	-305.8248	0.2655	-0.6286	58.3549	46.7616	-303.9666	69.4074	38.7265	-307.683
5.64	63.3664	41.45	-306.4182	0.1478	-0.3872	56.1744	44.383	-305.2615	70.5585	38.5169	-307.5749
5.664	66.1456	42.1027	-307.5379	0.0197	-0.5413	58.4014	46.7584	-307.3601	73.8897	37.4469	-307.7157
5.688	64.9885	42.1065	-308.8764	-0.0472	-0.3433	55.5902	45.4657	-309.3479	74.3868	38.7473	-308.405
5.712	66.0642	41.3442	-309.6291	-0.1132	-0.2336	56.3113	43.6645	-310.7692	75.8171	39.024	-308.4889
5.736	64.6538	42.0211	-311.412	-0.1391	-0.0617	54.971	42.619	-312.7698	74.3365	41.4232	-310.0543
5.76	67.0387	41.4514	-312.7396	-0.213	-0.1162	56.2445	42.7116	-315.0903	77.8329	40.1912	-310.389
5.784	66.6986	40.1899	-312.2564	-0.2689	-0.016	56.8333	40.3477	-314.9755	76.564	40.032	-309.5372
5.808	66.0341	41.7502	-313.4124	-0.1795	-0.0173	54.7646	41.9449	-315.458	77.3037	41.5556	-311.3667
5.832	68.0747	39.6262	-315.1536	-0.3241	0.1411	58.838	38.3144	-318.2874	77.3113	40.9381	-312.0198
5.856	67.1757	40.2591	-316.1785	-0.2018	0.1566	57.8636	38.7884	-318.1071	76.4877	41.7299	-314.2498

Rockan

time	pos(x)	pos(y)	pos(z)	el	az	x1	y1	z1	x2	y2	z2
0	0	0	0	0.7191	1.0345	-1.7514	-2.9462	3.0008	1.7514	2.9462	-3.0008
0.024	1.2237	0.137	-6.4562	0.6906	0.9101	-0.9891	-2.7098	-3.4769	3.4365	2.9838	-9.4355
0.048	2.1666	1.3639	-11.3355	0.5058	0.7885	-1.392	-2.2167	-8.5393	5.7252	4.9445	-14.1316
0.072	3.425	2.3102	-15.6954	0.5622	0.7872	-0.0974	-1.2248	-12.5516	6.9474	5.8451	-18.8391
0.096	5.2756	3.5454	-18.9015	0.6215	0.6399	1.6028	0.8116	-15.6225	8.9484	6.2792	-22.1806
0.12	7.359	4.7688	-22.8897	0.5151	0.6147	3.1148	1.7725	-19.9488	11.6031	7.7651	-25.8306
0.144	9.5196	5.2346	-28.13	0.5378	0.7132	5.8645	2.0724	-25.2475	13.1747	8.3968	-31.0125
0.168	13.6672	8.1015	-31.5209	0.181	0.7452	10.1407	4.8476	-30.643	17.1936	11.3554	-32.3989
0.192	15.2034	9.1152	-35.3745	0.135	0.7629	11.9173	5.974	-34.7569	18.4895	12.2564	-35.9921
0.216	17.94	11.4238	-38.2566	0.0821	0.6706	14.5197	8.711	-37.8973	21.3602	14.1366	-38.6159
0.24	18.9233	12.5378	-42.1496	-0.3718	0.8905	16.3572	9.3663	-43.7403	21.4894	15.7093	-40.559
0.264	20.2762	14.3762	-45.1014	-0.6561	1.2531	18.8787	10.1257	-48.5461	21.6737	18.6268	-41.6567
0.288	20.4308	15.1372	-44.9854	-1.0717	0.7133	18.5065	13.4721	-49.6532	22.3552	16.8023	-40.3177
0.312	21.1281	16.4399	-46.7134	-1.0062	1.0249	19.6898	14.0722	-51.0877	22.5664	18.8076	-42.3391
0.336	21.6927	16.8517	-49.5781	-0.661	0.8621	17.6815	12.1722	-54.3711	25.7038	21.5311	-44.7851
0.36	20.3104	16.955	-51.7175	-0.5906	0.6706	15.6426	13.2521	-55.7123	24.9782	20.6579	-47.7226
0.384	19.8956	17.9057	-52.4533	-0.7775	0.575	16.0267	15.3986	-56.9917	23.7644	20.4129	-47.915
0.408	15.6387	19.1232	-53.6707	-0.6946	0.6376	11.3606	15.9539	-58.1058	19.9168	22.2925	-49.2355
0.432	13.1978	19.5173	-55.4872	-0.575	0.667	8.9686	16.1871	-58.9754	17.427	22.8475	-51.999
0.456	11.9601	20.335	-55.4771	-0.3057	0.3361	3.657	17.4345	-58.2533	20.2633	23.2355	-52.7009
0.48	10.8695	21.2874	-55.7577	-0.0512	0.2173	1.3126	19.1778	-56.2587	20.4263	23.3969	-55.2566
0.504	9.7283	21.7311	-56.2067	0.147	0.2156	0.0299	19.6069	-54.7363	19.4267	23.8554	-57.677
0.528	8.8759	22.1573	-56.7988	0.3478	0.1976	0.4673	20.4738	-53.6894	17.2845	23.8407	-59.9081
0.552	8.8524	23.0188	-57.59	0.3709	0.2495	1.4922	21.1431	-54.6361	16.2127	24.8945	-60.5439
0.576	8.4978	22.9549	-58.5668	0.3982	0.3011	1.4375	20.7621	-55.4568	15.5582	25.1477	-61.6768
0.6	7.5233	23.0767	-59.5107	0.4494	0.4852	1.9567	20.1421	-56.4756	13.0898	26.0114	-62.5459
0.624	7.5101	23.2345	-59.1885	0.5554	0.4754	2.5744	20.6939	-55.744	12.4458	25.7751	-62.633
0.648	7.6745	23.8428	-60.0756	0.5678	0.6425	2.815	20.2056	-56.2037	12.5339	27.48	-63.9475
0.672	6.8102	25.288	-60.6549	0.5591	0.7456	2.8316	21.6138	-57.2664	10.7887	28.9622	-64.0434
0.696	6.5577	25.5747	-61.892	0.7308	0.7954	3.1031	22.0502	-57.4684	10.0122	29.0993	-66.3157

Rock14

time	pos(x)	pos(y)	pos(z)	el	az	x1	y1	z1	x2	y2	z2
0.72	5.8074	26.0672	-64.0868	0.6889	0.7709	1.9402	22.3105	-59.6471	9.6747	29.824	-68.5265
0.744	5.4004	26.6484	-64.6168	0.6862	0.8578	1.5471	22.1921	-59.7925	9.2536	31.1047	-69.4412
0.768	5.2575	27.0514	-66.033	0.8266	0.965	2.2092	22.651	-60.2191	8.3058	31.4518	-71.8469
0.792	4.9129	27.5353	-66.2503	0.8266	0.941	1.7261	23.1629	-60.3745	8.0997	31.9077	-72.1262
0.816	4.7507	28.5504	-67.8602	0.9104	0.9889	1.9165	24.2421	-61.2205	7.585	32.8586	-74.4999
0.84	4.6911	29.0038	-70.2844	0.7911	1.1754	2.5302	23.8267	-64.61	6.8521	34.1808	-75.9588
0.864	5.1736	29.0248	-73.0753	0.7635	1.206	3.1986	23.8527	-67.7764	7.1487	34.1969	-78.3742
0.888	3.6431	30.6439	-74.8817	0.7948	1.3473	2.4466	25.3792	-69.3804	4.8396	35.9085	-80.3829
0.912	2.9885	31.3755	-77.3358	0.755	1.1061	0.4975	26.4071	-72.1057	5.4795	36.3438	-82.5659
0.936	2.6355	32.1023	-79.0472	0.7417	1.1979	0.696	27.1446	-74.1697	4.5751	37.0601	-83.9246
0.96	2.6768	33.3374	-81.4878	0.6938	1.1885	0.4143	27.711	-76.4439	4.9393	38.9638	-86.5318
0.984	2.6307	33.9088	-83.6689	0.6251	1.1659	-0.1369	27.4519	-78.599	5.3982	40.3657	-88.7389
1.008	3.2234	34.6594	-85.8161	0.5672	1.3034	1.4269	28.1014	-81.485	5.02	41.2174	-90.1472
1.032	2.2616	36.1776	-88.1839	0.5155	1.378	0.9035	29.2222	-84.1685	3.6197	43.1329	-92.1994
1.056	2.6713	36.5728	-90.3568	0.4745	1.3425	1.058	29.6306	-86.6963	4.2847	43.5151	-94.0173
1.08	2.6464	38.0447	-92.6489	0.4183	1.1643	-0.2507	31.314	-89.3911	5.5435	44.7753	-95.9068
1.104	3.1527	39.6705	-95.2695	0.326	1.106	-0.4561	32.4733	-92.548	6.7614	46.8678	-97.991
1.128	3.528	40.8544	-97.9048	0.228	1.4714	2.7558	33.108	-96.0984	4.3001	48.6008	-99.7112
1.152	3.9288	41.8611	-100.6295	0.1287	1.5363	3.6874	34.8652	-99.7238	4.1703	48.8569	-101.5352
1.176	3.2896	43.0501	-102.2872	-0.0511	1.6066	3.5286	36.3679	-102.6293	3.0505	49.7323	-101.9451
1.2	3.7536	43.6358	-104.3698	-0.0571	1.8459	5.9167	35.973	-104.8248	1.5905	51.2987	-103.9147
1.224	3.2316	44.6609	-105.8767	-0.0836	1.9629	6.3553	37.1065	-106.5616	0.108	52.2152	-105.1917
1.248	4.8464	45.7394	-107.4922	-0.1756	2.0451	8.9983	37.6519	-109.1056	0.6946	53.8268	-105.8787
1.272	5.8335	47.445	-109.9487	-0.1678	2.18	11.3953	39.4746	-111.5951	0.2718	55.4155	-108.3023
1.296	6.2948	47.8624	-111.3842	-0.2055	2.2545	12.0322	40.8208	-113.2778	0.5573	54.9039	-109.4906
1.32	8.2654	47.9508	-112.7043	-0.1811	2.3743	14.5402	41.8988	-114.3007	1.9906	54.0027	-111.1078
1.344	8.6594	49.5622	-113.7536	-0.1922	2.4303	15.604	43.5776	-115.5379	1.7147	55.5468	-111.9694
1.368	10.0895	50.1507	-115.4538	-0.1386	2.5767	17.9073	45.1954	-116.7453	2.2717	55.106	-114.1623
1.392	11.487	51.0678	-117.2442	-0.041	2.6902	19.2877	47.2862	-117.6	3.6864	54.8495	-116.8883
1.416	16.9898	51.5648	-117.7364	0.0065	2.7001	27.3873	46.6504	-117.6617	6.5922	56.4792	-117.8111
1.44	19.0005	51.8837	-117.1632	0.0226	2.7186	29.9041	46.9756	-116.8934	8.0969	56.7919	-117.433
1.464	20.4884	52.8372	-117.6525	0.0864	2.682	30.3054	47.979	-116.7037	10.6715	57.6954	-118.6013
1.488	21.9396	53.8349	-118.9395	0.1638	2.7492	31.7839	49.7613	-117.1788	12.0954	57.9085	-120.7003
1.512	23.1782	53.6504	-118.8477	0.2301	2.7195	32.9901	49.2441	-116.3282	13.3662	58.0567	-121.3672
1.536	22.6884	55.0498	-120.0166	0.1822	2.7672	33.2951	50.8815	-117.9171	12.0816	59.218	-122.1161
1.56	22.0434	54.6649	-120.7867	0.2465	2.7638	30.701	51.2292	-118.4431	13.3858	58.1005	-123.1303
1.584	22.6025	54.5594	-120.8638	0.3293	2.7878	33.2795	50.6162	-116.974	11.9255	58.5026	-124.7536
1.608	23.9425	54.8074	-122.0423	0.4055	2.6998	33.1516	50.4522	-117.6688	14.7334	59.1627	-126.4158
1.632	24.285	56.3926	-121.9665	0.3885	2.7573	32.4744	53.0804	-118.3509	16.0956	59.7048	-125.5822
1.656	25.4915	56.5027	-123.7223	0.3455	2.7053	34.8474	52.1403	-120.007	16.1356	60.8651	-127.4377
1.68	23.0937	57.56	-124.4284	0.2995	2.6039	32.0674	52.2093	-121.2019	14.1199	62.9106	-127.6549
1.704	23.7199	58.33	-125.6296	0.308	2.6823	32.9737	53.7532	-122.3453	14.4662	62.9067	-128.9139
1.728	23.1183	59.1232	-126.9238	0.3239	2.6552	32.0515	54.3993	-123.5311	14.1851	63.8472	-130.3164
1.752	24.295	59.3028	-128.28	0.3248	2.6899	32.8353	55.1597	-125.0837	15.7547	63.4459	-131.4763
1.776	23.9582	60.3956	-129.3448	0.1763	2.6324	33.6759	54.9697	-127.3625	14.2406	65.8216	-131.327
1.8	23.2121	60.194	-130.9771	0.1978	2.5424	31.8601	54.2883	-128.8783	14.5642	66.0998	-133.0759
1.824	23.3426	61.8862	-132.6612	0.1911	2.5743	31.9674	56.3909	-130.6829	14.7177	67.3815	-134.6394
1.848	22.3344	61.607	-133.8281	0.0961	2.6322	31.8623	56.2856	-132.7766	12.8065	66.9284	-134.8796
1.872	22.7127	61.617	-135.2062	0.0341	2.5886	31.0977	56.442	-134.8701	14.3278	66.7921	-135.5423
1.896	22.2807	62.2651	-136.5712	0.0002	2.5998	30.2538	57.4659	-136.5698	14.3076	67.0642	-136.5727
1.92	22.1303	61.9672	-138.0051	-0.0908	2.5878	29.9066	57.1586	-138.8371	14.354	66.7758	-137.173
1.944	20.9969	62.4888	-138.7616	-0.1835	2.6299	28.3653	58.351	-140.3296	13.6285	66.6267	-137.1937
1.968	19.7734	62.553	-140.3873	-0.2095	2.4133	25.8147	57.1649	-142.1084	13.7321	67.9411	-138.6661
1.992	22.7626	63.4205	-141.8861	-0.3421	2.2366	26.1892	59.0576	-143.8613	19.336	67.7834	-139.9108
2.016	22.8468	64.0095	-143.6841	-0.332	2.0094	24.9179	59.5945	-145.3656	20.7757	68.4245	-142.0026
2.04	20.8468	64.6256	-143.5643	-0.3683	1.8967	22.2981	60.3318	-145.3135	19.3954	68.9195	-141.8151
2.064	20.0055	63.7667	-144.8214	-0.5185	1.7926	20.8702	59.9331	-147.0636	19.1408	67.6003	-142.5791
2.088	19.8084	62.7759	-146.6392	-0.4339	1.7329	20.5851	58.0278	-148.8686	19.0316	67.5241	-144.4098
2.112	17.7146	63.088	-147.3485	-0.0743	1.8166	19.2212	57.0839	-147.8093	16.208	69.0921	-146.8877
2.136	15.467	62.6195	-148.6531	-0.2238	1.9217	17.6547	56.6435	-150.1018	13.2792	68.5955	-147.2043
2.16	15.5407	62.9146	-149.2988	-0.1679	1.7046	16.3528	56.8837	-150.3299	14.7287	68.9455	-148.2676
2.184	14.1648	63.5552	-150.3006	-0.0574	1.886	16.3654	56.806	-150.7085	11.9643	70.3044	-149.8927
2.208	12.8316	64.0975	-151.8428	-0.1939	1.4849	12.3295	58.2682	-152.9916	13.3338	69.9267	-150.694
2.232	12.8083	64.111	-153.0165	-0.1703	1.4832	12.2415	57.6555	-154.1311	13.3751	70.5666	-151.9018
2.256	12.7352	64.3886	-153.6464	-0.3655	1.8681	14.8257	57.5665	-156.377	10.6448	71.2108	-150.9158
2.28	12.7132	64.5916	-155.0979	-0.4039	1.8756	14.8085	57.9326	-158.0816	10.618	71.2505	-152.1141

Rock14

time	pos(x)	pos(y)	pos(z)	el	az	x1	y1	z1	x2	y2	z2
2.304	12.0189	64.6555	-155.4287	-0.4934	1.9823	14.8257	58.2238	-159.2023	9.2121	71.0872	-151.6551
2.328	12.6431	64.9641	-157.7687	-0.4813	2.0243	16.0827	57.9075	-161.8687	9.2036	72.0207	-153.6688
2.352	11.3155	65.3669	-158.6925	-0.0805	1.8708	13.5842	58.0336	-159.3118	9.0469	72.7003	-158.0731
2.376	11.3005	65.3441	-160.3879	0.1136	1.6782	12.1616	57.3603	-159.4717	10.4394	73.3279	-161.3042
2.4	8.9657	65.5003	-160.9872	-0.0545	2.1765	14.7944	57.0838	-161.5454	3.137	73.9169	-160.4289
2.424	9.8285	66.0157	-162.1221	-0.0475	2.0539	13.6004	58.8247	-162.5083	6.0566	73.2067	-161.7336
2.448	4.5867	67.3475	-163.4533	0.0501	2.31	11.9593	59.2597	-162.9045	-2.786	75.4354	-164.0022
2.472	6.3866	67.3952	-165.09	0.0272	2.2449	12.6264	59.5853	-164.8177	0.1468	75.205	-165.3622
2.496	4.3467	68.3569	-166.5585	0.0084	2.4247	13.4028	60.4644	-166.4577	-4.7093	76.2495	-166.6594
2.52	6.819	67.2627	-168.034	-0.0835	2.455	15.3809	60.2446	-168.9611	-1.7429	74.2808	-167.1069
2.544	4.6449	68.3145	-169.4559	-0.0727	2.5828	15.51	61.5203	-170.3886	-6.2201	75.1088	-168.5232
2.568	4.4794	68.527	-170.7651	-0.0473	2.6556	15.9299	62.4788	-171.3777	-6.971	74.5751	-170.1525
2.592	4.8676	68.1367	-172.2619	-0.0604	2.6704	15.5959	62.671	-172.9903	-5.8607	73.6024	-171.5335
2.616	5.064	68.773	-173.4638	-0.0741	2.7016	16.3728	63.4491	-174.3922	-6.2448	74.097	-172.5354
2.64	5.6356	69.1101	-174.2208	-0.0913	2.7746	17.8737	64.4059	-175.4215	-6.6024	73.8142	-173.02
2.664	4.5337	69.6487	-175.4764	-0.1187	2.7814	17.562	64.7427	-177.1369	-8.4945	74.5547	-173.8159
2.688	6.0412	69.4334	-176.7551	-0.084	2.8149	18.3343	65.2679	-177.8476	-6.2519	73.5988	-175.6627
2.712	5.9261	70.0145	-177.6653	-0.2221	2.8576	18.446	66.3608	-180.6101	-6.5937	73.6683	-174.7205
2.736	7.815	70.179	-179.0395	-0.1951	2.8751	17.1635	67.6265	-180.9547	-1.5335	72.7315	-177.1244
2.76	7.8667	70.6775	-179.9565	-0.1748	2.9341	17.2781	68.6957	-181.6552	-1.5446	72.6593	-178.2579
2.784	7.9282	71.4987	-181.3344	-0.1922	2.9582	17.4026	69.7418	-183.2094	-1.5462	73.2556	-179.4594
2.808	10.1304	70.8264	-182.3098	-0.113	3.0161	18.8631	69.7252	-183.3084	1.3978	71.9277	-181.3112
2.832	10.1503	72.1608	-184.1699	-0.1161	2.9135	20.3343	69.7969	-185.3893	-0.0338	74.5247	-182.9504
2.856	10.1048	72.1763	-185.499	0.0083	2.9118	21.7493	69.453	-185.4002	-1.5396	74.8997	-185.5979
2.88	9.2751	72.5186	-186.1093	0.0528	2.8141	21.5947	68.3329	-185.4212	-3.0446	76.7042	-186.7974
2.904	10.8545	72.8079	-187.6572	0.0182	2.8247	21.7276	69.2424	-187.4488	-0.0186	76.3735	-187.8656
2.928	9.3794	73.2589	-189.8464	0.0992	2.8679	21.807	69.7703	-188.5618	-3.0482	76.7474	-191.1309
2.952	9.3447	73.9801	-190.9268	0.0483	2.8959	24.7945	70.1051	-190.1567	-6.1051	77.855	-191.6969
2.976	9.3838	73.9904	-191.582	0.0147	2.8733	23.3442	70.1519	-191.3691	-4.5766	77.829	-191.7949
3	9.3191	73.9793	-193.6831	0.0685	2.8101	23.2145	69.1958	-192.6745	-4.5763	78.7627	-194.6917
3.024	9.5864	74.4155	-195.3851	0.1051	2.979	22.2004	72.3462	-194.037	-3.0275	76.4848	-196.7332
3.048	11.1328	75.7364	-195.5822	0.0009	2.984	26.8307	73.2413	-195.5676	-4.5651	78.2315	-195.5967
3.072	11.157	75.3815	-197.8969	0.1094	2.9733	25.2942	72.9798	-196.3225	-2.9802	77.7832	-199.4713
3.096	9.7396	76.0889	-200.0194	0.0703	2.9968	23.983	74.0124	-199.0057	-4.5037	78.1655	-201.033
3.12	10.4716	76.2612	-201.377	0.0905	2.9275	23.9018	73.3418	-200.1302	-2.9586	79.1806	-202.6239
3.144	8.8874	76.3712	-204.0618	0.0663	2.845	22.3219	72.2652	-203.1288	-4.5472	80.4772	-204.9948
3.168	9.79	76.7305	-205.2271	-0.0182	2.8937	22.5416	73.5034	-205.4664	-2.9615	79.9577	-204.9878
3.192	9.7772	75.6016	-206.5298	-0.0033	2.9237	22.4679	72.7913	-206.5731	-2.9135	78.4119	-206.4865
3.216	7.3739	77.9616	-208.5863	0.0325	2.7707	22.3926	72.1203	-208.0617	-7.6449	83.803	-209.1109
3.24	9.0201	77.2801	-209.8938	-0.0081	2.7616	20.967	72.5083	-209.9975	-2.9268	82.0519	-209.7901
3.264	8.3161	76.2726	-212.731	0.0132	2.6876	17.9824	71.5561	-212.5891	-1.3503	80.9891	-212.8729
3.288	7.6916	77.2958	-214.9573	0.0752	2.6528	16.6272	72.5433	-214.195	-1.2439	82.0484	-215.7196
3.312	7.0359	75.172	-215.96	0.0344	2.7273	12.2013	72.9003	-215.766	1.8704	77.4437	-216.1539
3.336	4.7035	75.5881	-217.7458	0.0822	2.8194	15.1444	72.1031	-216.8393	-5.7374	79.0731	-218.6523
3.36	6.0532	73.3666	-219.0715	-0.0093	2.7567	17.7656	68.6216	-219.1887	-5.6593	78.1116	-218.9543
3.384	4.5847	74.092	-219.3386	0.0019	2.8403	17.9231	69.9476	-219.3115	-8.7537	78.2364	-219.3658
3.408	4.7426	75.6368	-220.659	0.0632	2.8209	16.6298	71.6888	-219.8657	-7.1446	79.5848	-221.4524
3.432	1.8279	75.5145	-222.5874	0.067	2.8558	12.3235	72.4311	-221.8534	-8.6677	78.598	-223.3213
3.456	0.2142	75.4856	-223.1824	0.0652	2.6762	10.6268	70.2565	-222.4211	-10.1984	80.7147	-223.9438
3.48	-1.2528	74.5388	-225.4087	0.0708	2.6531	9.1365	69.0177	-224.574	-11.6421	80.0598	-226.2433
3.504	-1.2825	74.2448	-225.5728	0.0564	2.6301	9.0771	68.4299	-224.9022	-11.6421	80.0598	-226.2433
3.528	-1.2703	73.0818	-227.3133	-0.0969	2.6172	9.1726	67.0421	-228.4857	-11.7133	79.1216	-226.1409
3.552	-2.1011	73.2221	-228.2517	-0.0733	2.594	10.6442	65.4496	-229.3478	-14.8464	80.9946	-227.1557
3.576	-3.4898	73.941	-229.5398	-0.0917	2.5949	7.8117	67.0632	-230.7567	-14.7914	80.8188	-228.3229
3.6	-2.6877	73.1215	-230.9566	-0.1121	2.6249	9.3217	66.2983	-232.5111	-14.6971	79.9447	-229.4022
3.624	-3.3166	73.4806	-232.3901	-0.1141	2.5244	6.3802	66.5992	-233.7533	-13.0134	80.362	-231.0268
3.648	-4.9597	74.3534	-233.0493	-0.1574	2.5541	6.5302	66.7014	-235.2399	-16.4496	82.0054	-230.8587
3.672	-7.1187	74.1416	-233.8368	-0.1839	2.593	3.6221	67.5776	-236.1786	-17.8595	80.7057	-231.495
3.696	-4.0669	72.8676	-237.0494	-0.2192	2.5865	8.1747	65.2759	-240.2581	-16.3085	80.4593	-233.8407
3.72	-3.9702	72.6653	-238.1731	-0.2613	2.511	6.7369	64.8493	-241.7187	-14.6774	80.4813	-234.6275
3.744	-4.5163	73.2495	-239.4503	-0.3311	2.4781	4.0096	66.5842	-243.1707	-13.0421	79.9149	-235.7298
3.768	-5.289	72.7484	-241.8965	-0.2717	2.6558	6.9812	66.2694	-245.7628	-17.5591	79.2273	-238.0302
3.792	-6.6699	72.6876	-242.7046	-0.3232	2.667	4.0695	67.1707	-246.7492	-17.4092	78.2044	-238.66
3.816	-8.2479	73.7134	-243.8126	-0.3843	2.5944	2.7295	67.0261	-249.0108	-19.2252	80.4007	-238.6143
3.84	-8.8073	73.6576	-245.2237	-0.4782	2.7292	1.3869	69.1982	-250.9904	-19.0016	78.1169	-239.457
3.864	-7.1433	71.9831	-247.0976	-0.3644	2.737	4.2747	67.0939	-251.8357	-18.5614	76.8723	-242.3595

Rock14

time	pos(x)	pos(y)	pos(z)	el	az	x1	y1	z1	x2	y2	z2
3.888	-6.4521	71.9466	-248.2337	-0.3703	2.8081	7.3454	67.1673	-253.902	-20.2496	76.726	-242.5654
3.912	-6.9915	72.4773	-249.9999	-0.4957	2.8527	2.9809	69.5131	-255.6254	-16.9639	75.4415	-244.3744
3.936	-5.3724	71.843	-251.4041	-0.4955	2.9202	6.0702	69.267	-257.7434	-16.8149	74.419	-245.0648
3.96	-5.9249	71.7283	-253.5639	-0.5232	2.9565	4.797	69.7204	-259.8559	-16.6467	73.7363	-247.2719
3.984	-5.7882	72.2422	-255.3199	-0.4341	3.0222	6.4453	70.7751	-261.0322	-18.0217	73.7093	-249.6076
4.008	-1.0878	70.3219	-257.3707	-0.3131	3.0802	12.3564	69.4949	-261.7321	-14.532	71.149	-253.0093
4.032	-4.8652	72.7882	-258.9532	-0.2776	3.0947	9.559	72.111	-263.0682	-19.2893	73.4654	-254.8382
4.056	-3.8924	72.1686	-260.0064	-0.2737	3.1411	11.3402	72.1607	-264.2826	-19.125	72.1765	-255.7302
4.08	-3.7988	71.8293	-260.8666	-0.1874	-3.0369	9.6471	73.2424	-263.4304	-17.2446	70.4163	-258.3029
4.104	-3.8692	71.3109	-261.1184	-0.1529	3.1266	12.561	71.0641	-263.6511	-20.2994	71.5577	-258.5856
4.128	-2.91	72.639	-263.0331	-0.0505	-3.0405	12.7456	74.2269	-263.8279	-18.5655	71.051	-262.2383
4.152	-1.8087	70.1262	-265.5648	-0.0227	-3.0118	12.864	72.0416	-265.9001	-16.4813	68.2108	-265.2295
4.176	-2.4029	70.5054	-266.8597	0.0453	-2.9442	11.4864	73.2835	-266.2177	-16.2923	67.7273	-267.5017
4.2	-0.0755	71.4429	-267.8908	0.0561	-2.8777	13.1272	75.0097	-267.1234	-13.2783	67.876	-268.6582
4.224	2.0863	71.3097	-269.5579	0.23	-2.7459	13.0703	75.8984	-266.771	-8.8977	66.7211	-272.3447
4.248	1.2903	71.988	-270.1815	0.2376	-2.8263	13.2405	75.8854	-267.1375	-10.6598	68.0906	-273.2256
4.272	0.0534	71.5705	-272.5721	0.3108	-2.8216	11.7147	75.4344	-268.6265	-11.608	67.7066	-276.5177
4.296	0.7556	72.4949	-274.0511	0.2911	-2.9206	13.5077	75.3597	-270.1347	-11.9965	69.6301	-277.9675
4.32	0.117	71.7417	-275.4077	0.2522	-2.9235	12.076	74.392	-272.2513	-11.8421	69.0915	-278.5642
4.344	1.1046	71.7126	-276.5167	0.3122	-2.8633	12.3243	74.9183	-272.7508	-10.1152	68.5069	-280.2825
4.368	0.5352	71.8411	-279.1136	0.2931	-2.9468	14.0074	74.4992	-274.9701	-12.937	69.183	-283.2571
4.392	-0.6778	69.8739	-281.2246	0.3193	-2.8638	12.397	73.6017	-276.7297	-13.7527	66.146	-285.7195
4.416	0.9685	68.0085	-284.7137	0.3792	-2.8824	11.0027	70.6688	-280.5769	-9.0657	65.3482	-288.8504
4.44	1.2048	70.0736	-284.5338	0.3885	-3.0371	12.1451	71.2212	-280.0313	-9.7355	68.9259	-289.0362
4.464	-0.8073	68.6163	-286.8202	0.3402	-3.0504	10.8483	69.6818	-282.6778	-12.4628	67.5509	-290.9625
4.488	-2.0939	67.3063	-289.1243	0.4062	-3.1117	8.1157	67.6113	-284.7316	-12.3034	67.0014	-293.5171
4.512	2.0178	65.3353	-290.406	0.4695	-2.9362	8.47	66.6795	-287.062	-4.4344	63.9911	-293.7501
4.536	-1.077	67.0078	-292.6875	0.418	-3.1132	8.3568	67.2756	-288.4958	-10.5107	66.74	-296.8792
4.56	-2.3451	65.9258	-293.6472	0.5702	-2.9629	2.749	66.8461	-290.3278	-7.4392	65.0056	-296.9667
4.584	-2.271	65.6426	-294.9115	0.4149	-2.9531	2.9664	66.6418	-292.5628	-7.5085	64.6434	-297.2602
4.608	-2.9056	65.1191	-296.882	0.4662	-2.6198	0.3018	66.9633	-295.0204	-6.113	63.2749	-298.7437
4.632	-5.598	63.3343	-298.3842	0.4549	-2.8945	-0.9865	64.4974	-296.0583	-10.2096	62.1713	-300.7101
4.656	-6.9788	61.8857	-299.235	0.2484	-2.8297	-2.5639	63.3091	-298.0586	-11.3938	60.4623	-300.4114
4.68	-8.5613	64.8996	-300.8185	0.314	-2.6556	-4.0968	67.2578	-299.1789	-13.0258	62.5415	-302.4581
4.704	-7.6853	62.2321	-301.1468	0.1332	-2.0299	-6.6034	64.4205	-300.8196	-8.7671	60.0436	-301.4739
4.728	-9.1294	61.9641	-302.0609	0.1156	-1.92	-8.1822	64.565	-301.7396	-10.0765	59.3632	-302.3823
4.752	-10.7967	59.3145	-303.6703	0.296	-2.368	-9.1734	60.8998	-302.9783	-12.42	57.7291	-304.3622
4.776	-10.7318	57.989	-303.7349	-0.4634	-2.0021	-9.2604	61.1859	-305.4934	-12.2031	54.7922	-301.9764
4.8	-13.0659	59.9135	-305.7671	0.1974	-1.8812	-12.2924	62.325	-305.2605	-13.8395	57.502	-306.2737
4.824	-15.0871	60.8116	-307.5189	-0.5716	-2.0741	-13.4348	63.8123	-309.7222	-16.7393	57.8109	-305.3156
4.848	-15.672	59.7089	-308.2425	-0.6981	-1.8434	-14.8138	62.7783	-310.9165	-16.5302	56.6394	-305.5684
4.872	-18.0969	58.2156	-309.3337	-0.7138	-1.7911	-17.3277	61.6505	-312.3823	-18.8661	54.7807	-306.2851

THIS PAGE INTENTIONALLY LEFT BLANK

APPENDIX D. SAMPLE MATLAB FILE FOR DATA ANALYSIS

```
% M-File MineMantaFinalTime.m

% ****DEFINE ALL VARIBALES TO PROCESS THE NEW FILE****
% dr - directory data file is located in
% flnm - name of file minus extension
% v1 - Initial Velocity for the drop
% L - Length along the long axis
% D - Diameter
clear all;
close all;
dr='../Allen_Drop_Data_ASCII/Manta_ASCII_Data/';
flnm='Manta15';
v1='3.199 m/s'; % Manually inputted initial velocity.
L=5.6372; D=5;

% *** Open and parse data file ****
fid=fopen([dr,flnm,'.mqa']);
fgetl(fid);
tt=fscanf(fid,'%f',[8,inf]);
% Because MAXTRAQ resets all time based on 30Hz, the loop puts all back to 125Hz.
m = size(tt);
n = m(2);
for i = 1:n
    time(i) = 0.00 - (1-i)*(0.016);
end
xyz1=tt(3:5,:); xyz2=tt(6:8,:);
fclose(fid);

zlm=[min(xyz1(3,end),xyz2(3,end))-1,max(xyz1(3,1),xyz2(3,1))+1];
xym=diff(zlm)/6; xlm=xym*[-1,1]; ylm=xym*[-1,1];

%set(gca,'xlim',xlm,'ylim',ylm,'zlim',zlm); hold on;

% *** TRANSFORM DATA ***
[pos,az,el]=xyz2ang(xyz2,xyz1);
xyz1=xyz1-pos(:,1)*ones(1,size(xyz1,2));
xyz2=xyz2-pos(:,1)*ones(1,size(xyz2,2));
pos=pos-pos(:,1)*ones(1,size(xyz2,2));
xyzh=pos+L/2*[cos(el).*cos(az);cos(el).*sin(az);-sin(el)];
xyzt=pos-L/2*[cos(el).*cos(az);cos(el).*sin(az);-sin(el)];

% *** FUNCTION - Save Final Processed Data File ****
*****
```

```

% The data file is saved as "flnm.dat"
data=[time;pos;el;az;xyz1;xyz2];
fid=fopen([flnm,'.dat'],'w+');
fprintf(fid,'%s\n',v1);
fprintf(fid,' time   pos(x)   pos(y)   pos(y)   el   az   x1   y1   z1   x2   y2   z2\n');
fprintf(fid,'%8.3f
% 10.4f% 10.4f% 10.4f% 10.4f% 10.4f% 10.4f% 10.4f% 10.4f% 10.4f% 10.4f% 10.4f% 10.4f\n',data);
fclose(fid);

```

```

% *** FUNCTION - POSITION PLOTS *****

```

```

% This function plots the y-z, x-z, and 3D plots for the paper
openfg(0.7*[6,8]);

```

```

% Y-Z Plot

```

```

axes('position',[0.1,0.97,0.8,0.03],'xlim',100*[-1,1]); axis('off');
text(0,0,[flnm,' V1=',v1],'horizontalalignment','center','fontsize',12);
axes('position',[0.1,0.07,0.4,0.88],'xlim',100*[-1,1],'ylim',[-300,5],'box','on');
hold on;
plot([xyzh(2,1:2:end);xyzt(2,1:2:end)],[xyzh(3,1:2:end);xyzt(3,1:2:end)],'b-');
plot(xyzh(2,1:2:end),xyzh(3,1:2:end),'ro','markersize',2);
plot([0,0],[-300,5],'g:');
xlabel('Y(cm)'); ylabel('Z(cm)');

```

```

% X-Z Plot

```

```

axes('position',[0.54,0.07,0.4,0.88],'xlim',100*[-1,1],'ylim',[-300,5],'box','on','xtick',[-50,0,50],'fontsize',10);
hold on;
plot([xyzh(1,1:2:end);xyzt(1,1:2:end)],[xyzh(3,1:2:end);xyzt(3,1:2:end)],'b-');
plot(xyzh(1,1:2:end),xyzh(3,1:2:end),'ro','markersize',2);
plot([0,0],[-300,5],'g:');
xlabel('X(cm)');
set(gca,'YTickLabel',[]);

```

```

% Save first two plots
svinsert([flnm,'2D'],7);

```

```

% 3D Data Plot

```

```

openfg(0.7*[6,8]);
set(gca,'xlim',100*[-1,1],'ylim',100*[-1,1],'zlim',[-300,5],'box','on');
hold on;
view([-34.5,10]);
plot3([xyzh(1,1:2:end);xyzt(1,1:2:end)],[xyzh(2,1:2:end);xyzt(2,1:2:end)],[xyzh(3,1:2:end);xyzt(3,1:2:end)],'b-');
plot3(xyzh(1,1:2:end),xyzh(2,1:2:end),xyzh(3,1:2:end),'r.','markersize',6);

```

```

xlabel('X(cm)'); ylabel('Y(cm)'); zlabel('Z(cm)');
plot3([0,0],[0,0],[-300,5],'g:');
plot3(100*[-1,1],[0,0],5*[1,1],'g:'); plot3([0,0],100*[-1,1],5*[1,1],'g:');
plot3(100*[-1,1],[0,0],-300*[1,1],'g:'); plot3([0,0],100*[-1,1],-300*[1,1],'g:');
% plot3([xyzh(1,end);xyzt(1,end)],[xyzh(2,end);xyzt(2,end)],-299*[1;1],'k-');
% ****SAVE FILE AS function sfinset(name,kpr) where kpr: 1-2: ps, 3-psc2, 4-jpeg, 5-
bmp256, 6-eps, 7-epsc, 8-tiff
svinsert([flnm,'3D'],7);

% ***** END POSITION PLOTS FUNCTION *****

% *** 3-D MOVIE FUNCTION *****
% loads wireframe model

[min3d,facdata,coldata,nosedata,colnose,taildata,coltail]=getManta3D;
min3dr=min3d'; nnb=size(min3dr,2);

% [bomb3d,facdata,colordata]=getbomb3Ddata(L,D);
% bomb3dr=bomb3d'; nnb=size(bomb3dr,2);

figure('units','inches','position',[5,0.5,6,9]);

k=1;
b3D=fbdmtr('zy',[az(k),el(k)]*min3dr;
CR=b3D+pos(:,k)*ones(1,nnb);

set(gca,'xlim',pos(1,k)+100*[-1,1],'ylim',pos(2,k)+100*[-1,1],'zlim',[-300,5],'box','on');
hold on;
view([-34.5,10]);
H=patch('vertices',CR,'faces',facdata,'FaceVertexCData',coldata,'FaceColor','flat','edgecolor','none');
H=[H;patch('vertices',CR,'faces',nosedata,'FaceColor',colnose)];
H=[H;patch('vertices',CR,'faces',taildata,'FaceColor',coltail)];

xlabel('X(cm)'); ylabel('Y(cm)'); zlabel('Z(cm)');
plot3([0,0],[0,0],[-300,5],'g:');
plot3(100*[-1,1],[0,0],5*[1,1],'g:'); plot3([0,0],100*[-1,1],5*[1,1],'g:');
plot3(100*[-1,1],[0,0],-300*[1,1],'g:'); plot3([0,0],100*[-1,1],-300*[1,1],'g:');

for k=2:length(time)
    b3D=fbdmtr('zy',[az(k),el(k)]*min3dr;
    CR=b3D+pos(:,k)*ones(1,nnb);
    set(H,'visible','off');

```

```

H=patch('vertices',CR,'faces',facdata,'FaceVertexCData',coldata,'FaceColor','flat','edgecolor','none');
H=[H;patch('vertices',CR,'faces',nosedata,'FaceColor',colnose)];
H=[H;patch('vertices',CR,'faces',taildata,'FaceColor',coltail)];

%set(H,'visible','on');
drawnow;
hold on;

plot3([xyzh(1,k),xyzt(1,k)],[xyzh(2,k),xyzt(2,k)],[xyzh(3,k),xyzt(3,k)],'erasemode','none')
;
plot3(xyzh(1,k),xyzh(2,k),xyzh(3,k),'r.','erasemode','none');

%****SAVE FILE AS function sfinsert(name,kpr) where kpr: 1-2: ps, 3-psc2, 4-jpeg,
5-bmp256, 6-eps, 7-eps, 8-tiff
text(0,100,[flnm,' V1=',v1],'horizontalalignment','center','fontsize',12);
svinsert([flnm,'mv',int2str(k)],4);
end
%*** END 3D MOVIE FUNCTION ****

```

LIST OF REFERENCES

- Arnone, R.A., and Bowen, Prediction Model of the Time History Penetration of a Cylinder through the Air-Water-Sediment Phases. NCSC Letter Report T34, Naval Coastal Systems Center, Panama City, FL, 1980.
- Baciocco, A.J., Jr., Technology for the United States Navy and Marine Corps, 2000-2035: Becoming a 21st Century Force, Undersea Warfare, Volume 7. National Academy of Sciences, 1997. (http://www.nap.edu/html/tech_21st/uw2.htm), 29 January 2006.
- Brown, J., Mine Warfare Brief, Defense Technical Information Center. (<http://www.dtic.mil/ndia/expeditionary/brown.pdf>) 30 January 2006.
- Chu, P.C., A.F. Gilles, C.W. Fan, J. Lan and P. Fleischer, "Hydrodynamics of falling cylinder in water column," *Adv. Fluid Mech.*, 2002a.
- Chu, P.C., T.B. Smith and S.D. Haeger, Mine impact burial prediction experiment. *Proceedings on the Fourth International Symposium on Technology and the Mine Problem*, Naval Postgraduate School, CD Rom, 2002b.
- Chu, P.C., C.W. Fan, A. D. Evans, A.F. Gilles, and P. Fleischer, Three-dimensional hydrodynamic model for prediction of falling cylinder through water column. DVD-ROM, The OCEANS 2003 MTS/IEEE Conference Proceedings, San Diego, CA, Sept. 22-26, 2003.
- Chu, P.C., C.W. Fan, A.D. Evans, and A.F. Gilles, Triple coordinate transforms for prediction of falling cylinder through the water column. *J. Applied Mech.*, 2004a.
- Chu, P.C., C.W. Fan, and A. D. Evans, "Three-dimensional rigid body impact burial model (IMPACT35)," *Adv Fluid Mech.*, 2004b.
- Chu, P.C., A.D. Evans, A. F. Gilles, T. Smith and V. Taber, "Development of Navy's 3D mine impact burial prediction model (IMPACT35)," *Proceedings on the Sixth International Symposium on Technology and the Mine Problem*, Naval Postgraduate School, DVD-ROM, 2004c.

Chu, P.C., A. F. Gilles and C.W. Fan, Experiment of falling cylinder through the water column. *Exper. Thermal Fluid Sci.*, 2005a.

Chu, P.C., and C.W. Fan, Prediction of falling cylinder through air-water-sediment columns. *J. Appl. Mech.*, 2005b.

Chu, P.C., and C.W. Fan, Pseudo-cylinder parameterization for mine impact burial prediction. *J. Fluids Eng.*, 2005c.

Chu, P.C., C.W. Fan, A.D. Evans, A. Gilles, T. B. Smith, and V. L. Taber, Development and Verification of 3D Mine Impact Burial Prediction Model (IMPACT35). *IEEE J. Oceanic Eng.*, 2005d.

Crowe, C.T., J.A. Roberson and D.F. Elger, *Engineering Fluid Mechanics*, Seventh Ed., John Wiley & Sons Inc, New York, 2001.

Elmore, P.A., R. Wilkens, T. Weaver and M. D. Richardson, IMPACT 28 and 35 simulations of 2003 Baltic Sea cruise: model results and comparison with data. *Fifth Annual ONR Workshop on Mine Burial Prediction*, Kona, Hawaii, Jan 31–Feb 2, 2005.

Gefken, P., 1/12-Scale Mk84 Model Testing. *Eighth Joint Classified Bombs/Warheads and Ballistics Symposium*, Monterey, California, August 18, 2005.

Holland, K.T., A.W. Green, A. Abelev and P.J. Valent, “Parameterization of the in-water motions of falling cylinders using high-speed video,” *Experi. Fluids*, DOI 10.1007/800348-004-0859-2, 2004.

Hurst, R.B., Mine Impact Burial Prediction Model – Technical Description of Recent Changes and Developments. Defense Scientific Establishment, Auckland, New Zealand, Report 149.

Knudsen, T., The Use and Development of Sea Mines, NDRF Summer Conference, 27 August 2004. PowerPoint Presentation. (<http://www.nrdf.dk/documents/groupp/SS04-Knudsen.pdf>) 30 January 2006.

Lott, D.F., K. Williams, and D. Jackson, Mine Burial in Carbonate Sediments. Proc. of the Technology and Mine Problem Symposium, November 1996, Naval Postgraduate School.

Mine Warfare Plan Fourth Edition, Program for the New Millennium. Washington, D.C., (http://www.exwar.org/Htm/ConceptDocs/Navy_USMC/MWP4thEd/appendix_a.htm) 30 January 2006.

Satkowiak, L.J., User's Guide for the Modified Impact Burial Prediction Model. NCSC TN 884-87. Naval Coastal Systems Center, Panama City, FL, 1987.

Smith, T.B., Mine Burial Impact Prediction Experiment. *Master Thesis*, Naval Postgraduate School, Monterey, CA, CA, 2000.

Taber, V.L., Environmental Sensitivity Study on Mine Impact Burial Prediction Model. *Master Thesis*, Naval Postgraduate School, Monterey, CA, 1999.

Valent, P.J., Holland, K.T., Green, A.W., Theophanis, S., King, C., Richardson, M.D., Bower, G.R., Congedo, P. and Lewis, W., "Observations of velocity and orientation of cylindrical shapes in free-fall in water," *Fifth International Symposium on Technology and the Mine Problem*, Naval Postgraduate School, Monterey, California, April 21–25, 2002.

Von Mises, R., *Theory of Flight*, 1st Ed., Dover Publications Inc., New York, 1959.

White, F.M., *Viscous Fluid Flow*, McGraw-Hill Inc., New York, 1974.

THIS PAGE INTENTIONALLY LEFT BLANK

INITIAL DISTRIBUTION LIST

1. Defense Technical Information Center
Ft. Belvoir, VA
2. Dudley Knox Library
Naval Postgraduate School
Monterey, CA
3. Mr. Brian Almquist
Office of Naval Research
Arlington VA
4. Professor Mary L. Batteen
Chairperson, Department of Oceanography
Naval Postgraduate School
Monterey, CA
5. Dr. Richard Bennett
SEAPROBE, Inc.
Picayune, MS
6. Mr. Ron Betsch
Naval Oceanographic Office, N01
Stennis Space Center, MS
7. Professor Peter Chu
Naval Postgraduate School
Monterey, CA
7. Dr. Tom Drake
ONR Coastal Geosciences Program, 321CG
Arlington, VA
8. Dr. Wayne Dunlap
OffShore Technology Research Center
College Station, TX
9. Dr. Peter Fleischer
Naval Oceanographic Office
Stennis Space Center, MS

10. Edward Gough
Naval Meteorology and Oceanography
Stennis Space Center, MS
11. Dr. Steve Haeger
Naval Oceanographic Office
Stennis Space Center, MS
12. CAPT Robert Kiser
Naval Meteorology and Oceanography
Stennis Space Center, MS
13. Mr. Mark Null
Naval Oceanographic Office
Stennis Space Center, MS
14. Dr. Mike Richardson
Naval Research Laboratory
Stennis Space Center, MS
15. Dr. Robert Stoll
Columbia University
Palisades, NY
16. Dr. Philip Valent
Naval Research Laboratory
Stennis Space Center, MS
17. Dr. Linwood Vincent
Office of Naval Research
Arlington, VA
18. Dr. Roy Wilkens
Office of Naval Research
Arlington, VA
19. Dr. Dick Yue
Department of Ocean Engineering
Massachusetts Institute of Technology
Cambridge, MA